

JANUARY 2020

# PRODUCT & PRICE GUIDE

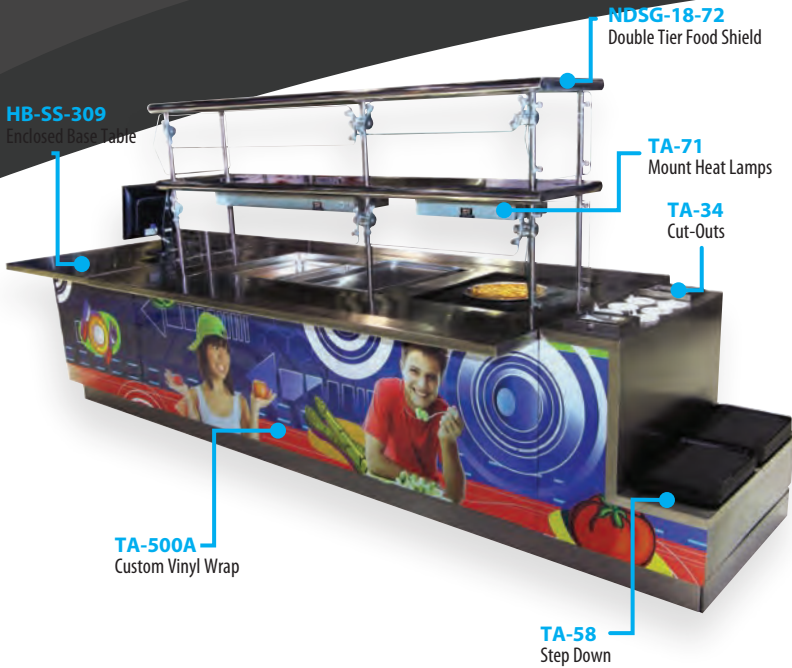

# Now That's SMART FABRICATION™



## LOOK AT WHAT WE'RE DOING

### CUSTOM FABRICATION

- Installation of Buyout Equipment
- Buyout Equipment Can Be Pre-Wired
- Load Centers Added
- Food Shields
- Laminate & Custom Vinyl Wraps Designed In-House



Concealed Load Centers for safety & easy access

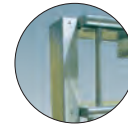

Custom Electrical Chases for buyout equipment



Wall Flashing in 16, 18 or 20 Ga. Stainless Steel & polished to a satin finish

## CREATE, ACCESSORIZE, UPSSELL

Buildatable And Buildasink Are Simple And Easy-To-Use Website Tools That Allow You To Click And Choose Accessories For Either A Work Table Or Sink.

**buildatable™**.com  
by ADVANCE TABCO®

**buildasink™**.com  
by ADVANCE TABCO®

For Smart Fabrication™ Quotes

Email [Smartfab@advancetabco.com](mailto:Smartfab@advancetabco.com) or call our Estimating Department at 800-498-6634.

## ONLINE SERVICES AVAILABLE AT [www.advancetabco.com](http://www.advancetabco.com)

### ACCOUNT ACCESS - CREATE A CUSTOMER LOG-IN & FOLLOW THE COMPLETE PROCESS OF YOUR ORDERS

#### KEEP TRACK OF:

- Print Status
- Shipment Tracking Status
- Real-time Order Status
- Latest Sales Flyer
- Excess Inventory Lists

#### ALSO AVAILABLE ONLINE:

- Spec Sheets, CAD & Revit Drawings
- Installation Guides
- Product Support
- Photo & Video Library
- Literature Requests

YOU CAN ALSO FIND US ON AUTOQUOTES & KCL CADALOG



**CUSTOMER SERVICE IS AVAILABLE TO ASSIST YOU! (8:30AM – 7:00PM EST)**

# TABLE OF CONTENTS

## SINKS & SINK ACCESSORIES

Drop-In Sinks.....	3-5
Undermount Sinks.....	5
Hand Washing Sinks.....	6-11
Mop Sinks & Mop Sink Cabinets ..	14-15
Multi-Station: Wall Mounted .....	16-19
Multi-Station: Free-Standing .....	20-23
Hand Sink Mods & Accessories .....	8, 11-13
Faucets, Drains & P-Traps .....	8, 11, 13, 34
Specialty Sinks .....	29
Mobile & Silver Soak .....	32
Budget Skullery Sinks .....	32
Budget Skullery Sink Accessories.....	32
NSF Regaline Sinks.....	24-28
NSF Fabricated Sinks .....	30-31
Sink Mods & Accessories .....	33-34
Floor Troughs, Floor Drains & Water Receptacles .....	35
Sink Cabinets .....	51
Integral Sinks.....	63

## TABLES & TABLE ACCESSORIES

Standard Work Tables.....	36-47
Enclosed Base Tables .....	48-50
Beverage Tables .....	50
Demo Tables.....	53
Tables with Sink .....	53
Corner Tables.....	53
Mobile Hand Sinks .....	51
Mixer Tables .....	54
Wall Mounted Tables.....	54
Equipment Stands.....	55
Filler Tables .....	55
Poly Top Tables.....	58
Work Table Modifications & Accessories .....	59-66
Wood Top Tables.....	56-57
Drawers & Accessories .....	64-65
Casters .....	66
Electrical Utility Chase.....	74

## FOOD SHIELDS

Food Shields for Multi-Use.....	67
Food Shields with S/S Shelf.....	67-68
Food Shields with Glass Top .....	67, 69
Self Serve Food Shields (No Top).....	70
Stationary Food Shields .....	70
Portable Food Shields.....	71
Food Shield Accessories .....	71

LED Lighting.....	71
-------------------	----

## STAINLESS STEEL SHELVING

Table Undershelving .....	66
Table Mounted Shelving .....	72-74, 77
Specialty Shelving .....	72-73, 76
Wall Mounted Shelving.....	74-75
Tubular Drainage Shelving.....	33
Ceiling Mounted Shelving .....	77
Shelving Accessories .....	77
Sorting Shelves For Dishtables .....	88

## POT RACKS

Shelving with Pot Racks.....	76
Table Mounted .....	78
Leg Mounted .....	80
Ceiling Mounted .....	80
Wall Mounted .....	80

## DISHTABLES

Soil Dishtables.....	82-83, 86
Clean Dishtables .....	84-85
3 Compartment Sink w/ Dishtable ...	86
Condensate Hoods.....	86
Vent Riser .....	86

Dishtable Modifications & Accessories .....	86-87
--	-------

## COUNTERTOPS

Stainless Steel Countertops.....	57
Integral Sinks.....	64

## CABINETS & WALL FLASHING

Stainless Steel Dish Cabinets .....	50
Sink Cabinets .....	51
Wall Cabinets .....	52
Storage Cabinets .....	52
Chemical Cabinets.....	52
Stainless Steel Wall Flashing .....	76

# Underbar Basics™

## UNDERBAR EQUIPMENT

### Underbar Drop-Ins

Drop-In Water Stations.....	90
Drop-In Bar Hand Sinks .....	90-91
Drop-In Ice Bins .....	90-91
Drop-In Countertop Drain Pans .....	90

### Bar Drink Rails

Drink Rails .....	91
-------------------	----

### Free-Standing Bar Sinks

Bar Hand Sinks .....	92
Bar Hand Sinks with Built-In Soap & Towel Dispensers.....	92

Bar Hand Sink Modifications & Accessories .....	92, 116
Bar Sinks .....	93
Bar Sink/Ice Bin Combos .....	93

### Glass Rinsers

Glass Rinser .....	91
--------------------	----

### Ice Bins

Drop-In Ice Bins .....	90-91
Free-Standing Ice Bins.....	94-95
Ice Bin with Bottle Storage .....	95
Portable Ice Bin .....	95
Ice Bin & Drainboard Combo.....	95
Pass-Thru Ice Bins .....	96
Beer Boxes .....	99
Ice Bin Mods & Accessories .....	94, 116

### Pass-Thru Work Stations

Standard Pass-Thru Workstations .....	96
---------------------------------------	----

### Bar Drainboards

Free Standing Bar Drainboards .....	97
Recessed Bar Drainboards.....	97
Beer Drainers .....	97
Frozen Drink Machine Stands.....	97
Drainboard with Blender Station .....	98
Drainboard Cabinets.....	100

### Blender Stations

Blender Station with Dump Sinks.....	98
Double Step Blender Stations.....	98
Blender Station Mods & Accessories .....	98, 116, 118

### Uni-Serv Speed Bars

Complete Speed Bar Unit .....	98
-------------------------------	----

### Bar Storage Units

Liquor Bottle Displays .....	99
Glass Rack Storage Cabinets.....	100
Drainboard Cabinets.....	100
With Dump Sink & Waste Chute .....	100
Storage Unit Accessories & Modifications .....	100, 116, 118

### Speed Rails

Stainless Steel Speed Rails .....	101
Black Plastic Speed Rails .....	101
Heavy Duty Speed Rails .....	101

### Underbar Mods & Accessories

Underbar Mods & Accessories .....	116-118
Underbar Faucets .....	118

*Continued on Page 2*



**WARNING:** Equipment contained in this Price Guide may expose you to chemicals, including chromium & lead, that are known to the State of California to cause cancer or birth defects or other reproductive harm. For more Info., visit [www.p65warnings.ca.gov](http://www.p65warnings.ca.gov).



= PRODUCTS THROUGHOUT THE PRICE GUIDE WITH THIS ICON ARE SHIPPED VIA UPS

# TABLE OF CONTENTS



## UNDERBAR EQUIPMENT

### Prestige Modular Bar Die Systems

Exclusive Bar Die System ..... 103-104

### Prestige Free-Standing Bar Sinks

Bar Hand Sinks ..... 105

Bar Hand Sinks with Built-In

Soap & Towel Dispensers..... 105

Bar Hand Sinks with Cabinet Base ... 105

Bar Sink Mods

& Accessories .....105, 117, 118

Bar Sinks ..... 106

### Prestige Ice Bins

Free-Standing Ice Bins..... 70

Ice Bin & Bottle Storage..... 70

Pass-Thru Ice Bins ..... 108

Beer Box..... 108

### Prestige Pass-Thru Work Stations

Standard Pass-Thru Workstations .... 108

Overshelves For Pass-Thru

Workstations..... 108

### Prestige Bar Drainboards

Free Standing Bar Drainboards ..... 109

Recessed Bar Drainboards..... 109

Beer Drainers ..... 105

Frozen Drink Machine Stands..... 109

Drainboard Fillers..... 110

With Blender Station..... 111

Drainboard Storage Cabinets ..... 112

Drainboard Glass Rack Storage ..... 113

### Prestige Blender Stations

With Deep Drawn Sink ..... 111

With Drainboard .....111

Blender Shelf ..... 114

### Prestige Uni-Serv Speed Bars

Complete Speed Bar Unit ..... 111

### Prestige Bar Storage Units

Point of Service Cabinet.....109

Drainboard Storage Cabinets .....112

Glass Rack Storage Cabinets..... 113

Liquor Bottle Displays ..... 113

### Trash Receptacles

Trash Receptacle Cabinets..... 112

### Prestige Speed Rails

Stainless Steel Speed Rails ..... 114

Hang-On Style Speed Rails ..... 114

### Under Bar Mods & Accessories

Soda Gun Holder for Prestige®

Pass-Thru Workstations ..... 117

Prestige Mods & Accessories... 117-118

### BACK BAR REFRIGERATION & COOLERS

Glass Froster..... 115

Bottle/Can Coolers..... 115

Back Bar Refrigeration ..... 115

### PORTABLE BARS

Stainless Steel Work Top ..... 119

Stainless Steel Top, Back & Sides ... 119

### Heavy Duty Bars

Heavy Duty Bars ..... 119

With Stainless Steel Doors ..... 119

Portable Bar with Laminates .....119

Portable Bar Mods & Accessories ....120

### HOT/COLD FOOD UNITS

#### Hot Well Drop-In Units

Standard Drop-In Units ..... 122

Slimline Drop-In Units..... 122

Hot Well Drop-In Accessories ..... 122

#### Hot Well Food Tables

Electric Powered Hot Food Tables ... 123

Electric Powered Sealed Well Tables 124

Gas Powered Hot Food Tables ..... 125

Gas Powered Wetbath Tables ..... 126

#### Solid Top Food Tables

Solid Top Food Tables..... 127

#### Cold Well Drop-In Units

Ice-Cooled Drop-In Cold Pan Units .. 128

Refrigerated Drop-In Cold Pan Units .128

#### Cold Food Tables

Standard Ice-Cooled Tables ..... 129

Mechanically Assisted

Cold Pans Tables..... 130

#### Heavy Duty Food Tables

Electric Sealed Hot Well Tables ..... 131

Refrigerated Cold Well Tables ..... 131

Ice-Cooled Tables..... 131

### Everyday Buffet Tables

Electric Hot Well Buffets..... 132

Electric Sealed Hot Well Buffets..... 132

Ice Cooled Buffets..... 133

Solid Top Buffets..... 133

Mechanically Assisted

Cold Pan Buffets ..... 134

Cash Register Stands ..... 134

Silverware Stand..... 134

Everyday Buffet Accessories ..... 135

### Food Table Shelving & Parts

Hot/Cold Food Table Shelving..... 135

Food Shields for Hot/cold Tables .....136

Hot Food Table Parts

& Accessories ..... 123-124, 134-138

LED Lighting for Hot/Cold Tables .... 137

### ALUMINUM RACKS & PANS

Aluminum Racks ..... 139-145

Aluminum Bun Pans..... 144

Aluminum Rack Accessories ..... 144

### Mobile Racks & Carts

Aluminum Pan Trucks ..... 145

Aluminum Dunnage Racks ..... 145

Utility Carts ..... 145

### WIRE SHELVING

Wire Utility Carts ..... 147

Chrome & Green Epoxy

Wire Shelving..... 146-147

Wall Mounted Shelving System..... 148

Wire Shelving Replacement Parts

& Accessories ..... 148

### WARRANTY

Warrantee, Terms & Conditions ..... 149



= PRODUCTS THROUGHOUT THE PRICE GUIDE WITH THIS ICON ARE SHIPPED VIA UPS



# DROP-INS

## Drop-In Sinks

INCLUDES K-52 LEAD FREE COMPLIANT FAUCET & BASKET DRAIN. (DI-1-25 INCLUDES 2" DRAIN WITH STRAINER PLATE)  
(To delete faucet, order K-52OMIT and deduct \$22)

All Sinks on this Page Ship Via UPS

### ONE COMPARTMENT

Countertop Mounted, Self Rim Design

For Residential Finish & Packaging,  
Add K-350 \$360



#### DI-1-5 \$510

10" x 14" x 5" Bowl  
Overall: 13" x 19"  
Cut-out: 12 1/4" x 18 1/4"  
12 lbs. 2 cu. ft. 20 gauge



#### DI-1-10 \$638

10" x 14" x 10" Bowl  
Overall: 13" x 19"  
Cut-out: 12 1/4" x 18 1/4"  
14 lbs. 2 cu. ft. 20 gauge



#### DI-1-25 \$632

**Space Saver**  
9" x 9" x 5" Bowl  
Overall: 12" x 14"  
Cut-out: 11 1/4" x 13 1/4"  
8 lbs. 2 cu. ft. 20 gauge



#### DI-1-1515 \$764

12 1/4" x 10 1/4" x 6" Bowl  
Overall: 15" x 15"  
Cut-out: 14 1/4" x 14 1/4"  
Requires 1 1/2" Radius Corners  
11 lbs. 2 cu. ft. 20 gauge



#### DI-1-35 \$573

14" x 10" x 5" Bowl  
Overall: 17" x 15"  
Cut-out: 16 1/4" x 14 1/4"  
10 lbs. 2 cu. ft. 20 gauge



#### DI-1-168 \$819

16" x 14" x 8" Bowl  
Overall: 19" x 19"  
Cut-out: 18 1/4" x 18 1/4"  
20 lbs. 3 cu. ft. 18 gauge



#### DI-1-208 \$875

20" x 16" x 8" Bowl  
Overall: 23" x 21"  
Cut-out: 22 1/4" x 20 1/4"  
20 lbs. 3 cu. ft. 18 gauge



#### DI-1-2012 \$1005

20" x 16" x 12" Bowl  
Overall: 23" x 21"  
Cut-out: 22 1/4" x 20 1/4"  
20 lbs. 6 cu. ft. 18 gauge



#### DI-1-5SP \$1472

**6" Tapered Side Splash**

Splash on Rear and Both Sides  
10" x 14" x 5" Bowl  
Overall: 13" x 19"  
Cut-out: 12 1/4" x 18 1/4"  
16 lbs. 2 cu. ft. 20 gauge



#### DI-1-10SP \$1582

**6" Tapered Side Splash**

Splash on Rear and Both Sides  
10" x 14" x 10" Bowl  
Overall: 13" x 19"  
Cut-out: 12 1/4" x 18 1/4"  
18 lbs. 2 cu. ft. 20 gauge



#### DI-1-30 \$958

**2" Tapered Side Splash**

14" x 10" x 5" Bowl  
Overall: 16" x 15"  
Cut-out: 15" x 14 1/4"  
12 lbs. 2 cu. ft. 20 gauge

Splash on All 3 Sides

Optional 12" Tapered Side Splash Upgrade K-12SS \$457

**IMPROVED!**  
Stronger Acuator



Includes water filler faucet, grating & drain

#### DI-1-9 \$1000

**Filler Station**  
9" x 9" x 3" Bowl  
Overall: 12" x 14"  
Cut-out: 11 1/4" x 13 1/4"  
15 lbs. 2 cu. ft. 20 gauge

### Removable 8" Splash Wrap for Existing Drop-In Sinks \$773 ea.

Model #	Fits Drop-In Sink:
K-614A	DI-1-25 & DI-1-9
K-614B	DI-1-5 & DI-1-10
K-614C	DI-1-1515
K-614D	DI-1-30 & DI-1-35
K-614E	DI-1-168
K-614F	DI-1-208 & DI-1-2012
K-614G	DI-1-2812



Protect Your Surrounding Area!

### The Largest One Compartment Drop-In Sink in the Industry!

#### DI-1-2812 \$1713

28" x 20" x 12" Bowl  
Overall: 31" x 25"  
Cut-out: 30 1/4" x 24 1/4"  
47 lbs. 7 cu. ft. 16 gauge



Supplied with K-53 Lead Free Compliant Faucet & Basket Drain  
(To delete faucet, Order K-53OMIT and deduct \$22)

**WARNING:** Equipment that includes a faucet may expose you to chemicals, including lead, that are known to the State of California to cause cancer or birth defects or other reproductive harm. For more info, visit [www.p65warnings.ca.gov](http://www.p65warnings.ca.gov).

# DROP-INS

## Drop-In Sinks



= Ship Via UPS

Holes Punched 4" O.C. For Faucet Hole Revision Order **K-472 \$121**. Cut-Out Size Requires 1-1/4" Radius Corners. Maximum Counter Thickness Is 2".

**INCLUDES K-50 LEAD FREE COMPLIANT FAUCET & BASKET DRAIN** (To delete faucet, order K-500MIT and deduct \$22)

### TWO COMPARTMENT

Countertop Mounted, Self Rim Design



#### DI-2-10 \$1246

10" x 14" x 10" Bowl  
Overall: 25 1/2" x 19"  
Cut-out: 24 3/4" x 18 1/4"  
26 lbs. 4 cu. ft. 20 gauge



#### DI-2-2012 \$1985

20" x 16" x 12" Bowl  
Overall: 45 1/2" x 21"  
Cut-out: 44 3/4" x 20 1/4"  
42 lbs. 9 cu. ft. 18 gauge



#### DI-2-1410 \$1896

14" x 16" x 10" Bowl  
Overall: 33 1/2" x 21"  
Cut-out: 32 3/4" x 20 1/4"  
35 lbs. 6 cu. ft. 18 gauge



#### DI-2-208 \$1551

20" x 16" x 8" Bowl  
Overall: 45 1/2" x 21"  
Cut-out: 44 3/4" x 20 1/4"  
40 lbs. 6 cu. ft. 18 gauge

### THREE COMPARTMENT

Countertop Mounted, Self Rim Design

#### DI-3-10 \$1908

10" x 14" x 10" Bowl  
Overall: 38" x 19"  
Cut-out: 37 1/4" x 18 1/4"  
34 lbs. 5 cu. ft. 20 gauge



#### DI-3-1410 \$2555

16" x 14" x 10" Bowl  
Overall: 50" x 21"  
Cut-out: 49 1/4" x 20 1/4"  
38 lbs. 8 cu. ft. 18 gauge



#### DI-3-1612 \$2878

16" x 20" x 12" Bowl  
Overall: 56" x 25"  
Cut-out: 55 1/4" x 24 1/4"  
60 lbs. 12 cu. ft. 18 gauge



Includes a K-53 Faucet. To delete, order K-530MIT & deduct \$22

**DID YOU KNOW?** 2 & 3 Compartment Drop-In Sinks are N.S.F. Approved when only used in Mobile Food Carts and Kiosks.

# FAUCETS & SPOUTS

## Deck Mounted Faucets, Spouts & Mounting Clips

#### Drinking Bubbler

K-47 \$721



#### 8" Swing Spout

K-50 \$245



4" O.C.

#### Water Filler Faucet

K-54

8-1/4" High \$468

K-54A

12" High \$576

**IMPROVED!**  
Stronger Actuator



#### Swing Spout Faucet & Spray

K-58 \$303

8" O.C.



#### Mounting Clips Extended



For Countertops Over 7/8" & up to 2" Thick

Quantity supplied (4-Pack), varies based on drop-in sink ordered.

K-28 \$14

#### Deck Mounted Single Handle Faucet

K-48 \$505



#### 3-1/2" Gooseneck

K-52 \$221

4" O.C.



#### Large 8-1/2" Spout Gooseneck

K-55 \$427

4" O.C.



#### EXTRA HEAVY DUTY Gooseneck

K-62 \$439

4" O.C.

**Upgrade**



#### 12" Swing Spout

K-53 \$427

4" O.C.



#### Deck Mounted Faucet with Wrist Handles

K-56 \$322

4" O.C.



#### 6" Deck Mounted Extended Faucet with Wrist Handles

K-208 \$445

4" O.C.



#### FAUCET REPAIR KITS\*

For K-50, K-52, K-53, K-55, K-56

K-00B \$115

(2 Cartridges & 2 Handles Per Set)

\*Can Only Be Used On Faucets Purchased After January 2016. For Older Faucets, Consult Customer Service.

For K-54 & K-54A Filler Faucet

K-02 \$95

Purchased from 2016 to 2019



K-02A \$95

Purchased before 2016 or after 2019



K-00B Shown

**WARNING:** Equipment that includes a faucet may expose you to chemicals, including lead, that are known to the State of California to cause cancer or birth defects or other reproductive harm. For more info, visit [www.p65warnings.ca.gov](http://www.p65warnings.ca.gov).

# SMART SERIES™

Countertop Mounted, Self Rim Design

# DROP-INS

## Drop-In Sinks

Maximum Counter Thickness is 2". 8" O.C. Faucet Holes: Unit punched with 1-1/4" Diameter for the hot & cold water supply lines. Center hole punched with 1" Diameter. For Faucet Hole Revision Order **K-472 \$121**.

- 18 Gauge, Seamless Deep Drawn Self Rimming Stainless Steel Bowls.
- Bowls Are Sound Deadened.
- Flat Deck Allowing More Faucet Options.
- Units Feature Advance Tabco's Smart Finish.
- Faucet Optional

SS-1-1715-7  
Shown



SS-1-2321-10  
Shown



SS-2-3321-10  
Shown



### SINGLE BOWL DROP-IN SINKS

Model #	Price	O.A. Size L x W	Bowl Size L x W	Cut-Out Size (1 1/4" Radius Corners)	Wt.	Cu. Ft.
SS-1-1319-10	\$1010	13" x 19"	14" x 10" x 10"	12 1/4" x 18 1/4"	14 lbs.	2
SS-1-1715-7	1010	17" x 15"	14" x 10" x 7 1/2"	16 1/4" x 14 1/4"	12 lbs.	2
SS-1-1715-10	1125	17" x 15"	14" x 10" x 10"	16 1/4" x 14 1/4"	14 lbs.	3
SS-1-1919-7	1199	19" x 19"	16" x 14" x 7 1/2"	18 1/4" x 18 1/4"	16 lbs.	3
SS-1-1919-10	1267	19" x 19"	16" x 14" x 10"	18 1/4" x 18 1/4"	18 lbs.	4
SS-1-1919-12	1318	19" x 19"	16" x 14" x 12"	18 1/4" x 18 1/4"	20 lbs.	4
SS-1-2321-10	1425	23" x 21"	20" x 16" x 10"	22 1/4" x 20 1/4"	22 lbs.	6
SS-1-2321-12	1515	23" x 21"	20" x 16" x 12"	22 1/4" x 20 1/4"	24 lbs.	6

### DOUBLE BOWL DROP-IN SINKS

SS-2-3321-10	1630	33 1/2" x 21"	14" x 16" x 10"	32 3/4" x 21 1/4"	35 lbs.	6
SS-2-3321-12	1777	33 1/2" x 21"	14" x 16" x 12"	32 3/4" x 21 1/4"	37 lbs.	9
SS-2-4521-10*	1913	45 1/2" x 21"	20" x 16" x 10"	44 3/4" x 21 1/4"	39 lbs.	9
SS-2-4521-12*	2090	45 1/2" x 21"	20" x 16" x 12"	44 3/4" x 21 1/4"	40 lbs.	10



## LAUNDRY ROOM SINK



- 16 Gauge
- Three 4" O.C. Holes\*
- Bowl Size: 24" x 18" x 14"\*\*\*
- Overall Size: 27" x 23"
- Cutout: 26 1/4" x 20 1/4"

**LS-2418-14RE \$2665**

\*\* Requires 30" Wide Countertop (Front to Back)

\*Shown with Faucet Hole Revision **K-472 \$121**

## STAINLESS STEEL SINK GRIDS

- Perforated Grid
- Raised Bottom
- Side Notches for Easy Removal

**K-610 \$706**

(Specify Bowl Size When Ordering)



# UNDERMOUNTS

- 3 1/2" Drain Opening, 1-1/2" IPS Drain
- 1-1/4" Outside Flange



2028A-12 Shown



CO-1014A-10RE Shown

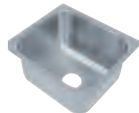

Undermount Bowls are suitable to be welded by others into stainless steel products. Multiple compartment assemblies available. Call for pricing.

Model #	Price	Gauge	Bowl Size LxWxD	Radius	O.D. Trim Size
1014B-05	\$366	20	10" x 14" x 5"	2"	12 1/2" x 16 1/2"
1014A-10	444	20	10" x 14" x 10"	2"	12 1/2" x 16 1/2"
1014A-10A	573	18	10" x 14" x 10"	2"	12 1/2" x 16 1/2"
CO-1014A-10RE*	809	18	10" x 14" x 10"	2"	12 1/2" x 16 1/2"
CO-1416A-10RE*	857	18	14" x 16" x 10"	3"	12 1/2" x 18 1/2"
1620A-10	710	18	16" x 20" x 10"	3"	18 1/2" x 22 1/2"
1620A-12	846	18	16" x 20" x 12"	3"	18 1/2" x 22 1/2"
1620A-14A	1047	14	16" x 20" x 14"	3"	18 1/2" x 22 1/2"
1824A-12	1483	18	18" x 24" x 12"	3"	20 1/2" x 26 1/2"
1824A-14A	1663	14	18" x 24" x 14"	3"	20 1/2" x 26 1/2"
2020A-12	947	18	20" x 20" x 12"	3"	22 1/2" x 22 1/2"
2020A-14	1022	18	20" x 20" x 14"	3"	22 1/2" x 22 1/2"
2028A-12	1569	16	20" x 28" x 12"	3"	22 1/2" x 30 1/2"
2028A-14A	1763	14	20" x 28" x 14"	3"	22 1/2" x 30 1/2"
2424A-14A	1846	14	24" x 24" x 14"	3"	26 1/2" x 26 1/2"

\* Includes Residential Finish & Packaging. Add **K-350 \$360** for Other Models to Add Residential Finish & Packaging.

**WARNING:** Equipment that includes a faucet may expose you to chemicals, including lead, that are known to the State of California to cause cancer or birth defects or other reproductive harm. For more info., visit [www.p65warnings.ca.gov](http://www.p65warnings.ca.gov).

# HAND SINKS

## Hand Washing Sinks



To delete faucet, order K-590MIT and deduct \$22

= All Sinks On This Page Ship Via UPS



All Sinks on this Page

### STANDARD UNITS

Bowl Size: 10" x 14" x 5" • Overall Size: 15 1/4" x 17 1/4" Unless Otherwise Specified  
Includes K-59 Splash Mount Faucet, 3-1/2" Basket Drain & Wall Bracket (Unless Otherwise Specified)



**7-PS-60 \$624**  
Standard Unit  
13 lbs. 2 cu. ft. 20 gauge



**7-PS-68 \$742**  
K-316 Splash Mount  
Wrist Handle Faucet  
13 lbs. 2 cu. ft. 20 gauge



**7-PS-67 \$690**  
Lever Operated  
15 lbs. 2 cu. ft. 20 gauge



**7-PS-50 \$815**  
Lever Operated  
with Overflow & P-Trap  
15 lbs. 2 cu. ft. 20 gauge



**7-PS-54 \$753**  
1 1/2" P-Trap  
15 lbs. 2 cu. ft. 20 gauge



**7-PS-20 \$650**  
K-22 Deck Mount Faucet  
15 lbs. 3 cu. ft. 20 gauge  
**Overall Size:**  
17-1/4" x 17-1/4"

### SIDE SPLASH UNITS

Bowl Size: 10" x 14" x 5" • Overall Size: 15 1/4" x 17 1/4" Unless Otherwise Specified  
Includes 7-3/4" High Welded Side Splashes, K-59 Splash Mount Faucet, 3-1/2" Basket Drain & Wall Bracket (Unless Otherwise Specified)



**7-PS-66R or L \$985**  
Right or Left Side Splash  
13 lbs. 2 cu. ft. 20 gauge

Unit Shown:  
7-PS-66R



**7-PS-66 \$1061**  
Standard Unit  
19 lbs. 2 cu. ft. 20 gauge



**7-PS-66W \$1141**  
K-316 Splash Mt. Faucet  
w/ Wrist Handles  
19 lbs. 2 cu. ft. 20 gauge



**7-PS-40 \$1296**  
Lever Operated  
With Overflow & P-Trap  
20 lbs. 2 cu. ft. 20 gauge



**7-PS-76 \$1655**  
Full Length Removable  
Utility Tray  
K-59 Splash Mt. Faucet  
Lever Operated  
With Overflow & P-Trap  
12" High Welded Side Splashes  
24 lbs. 2 cu. ft. 20 gauge



**7-PS-87 \$2141**  
Towel & Soap Dispenser  
K-316 Splash Mt. Faucet  
with Wrist Handles  
Lever Operated  
With Overflow & P-Trap  
34 lbs. 10 cu. ft. 20 gauge

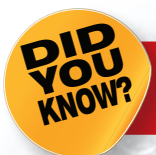

You Can Add Side Splashes To Any Hand Sink  
See Page 12



**7-PS-73 \$2080**  
7 3/4" High Side Splashes  
Towel Dispenser  
Deck Mt. Soap Dispenser  
K-123 Splash Mt. Faucet  
31 lbs. 5 cu. ft. 20 gauge

**WARNING:** Equipment that includes a faucet may expose you to chemicals, including lead, that are known to the State of California to cause cancer or birth defects or other reproductive harm. For more info, visit [www.p65warnings.ca.gov](http://www.p65warnings.ca.gov).





All Sinks on this Page



All Sinks On This Page Ship Via UPS

# HAND SINKS

## Hand Washing Sinks

### SOAP & TOWEL DISPENSER UNITS

Bowl Size: 10" x 14" x 5" • Overall Size: 15 1/4" x 17 1/4"

Includes C-Fold Style Towel Dispenser, Liquid Soap Dispenser, K-59 Splash Mount Faucet, 3-1/2" Basket Drain & Wall Bracket (Unless Otherwise Specified)

To delete faucet, order K-590MIT and deduct \$22



**7-PS-69 \$2303**  
K-69 T & S Splash Mounted Faucet  
With Wrist Handles  
Lever Operated With Overflow & P-Trap  
Side Support Brackets  
35 lbs. 6 cu. ft. 20 gauge



**7-PS-79 \$1557**  
Standard Unit  
32 lbs. 10 cu. ft. 20 gauge



**7-PS-80 \$1706**  
Lever Operated  
With Overflow & P-Trap  
32 lbs. 10 cu. ft. 20 gauge

ALL-IN-ONE  
UNIT



**7-PS-85 \$1898**  
P-Trap & Skirt  
35 lbs. 6 cu. ft. 20 gauge

### UNDERMOUNT TOWEL DISPENSER UNITS

**7-PS-41 \$4608**

A.D.A. Compliant Tapered Bowl Design  
Hands Free Operated Faucet  
Undermount Towel Dispenser  
1-1/2" Drain w/ Flat-Top Strainer Plate  
16 Gauge Skirt with Enclosed Bottom  
For Storage w/ Removable Access Panel  
43 lbs. 8 cu. ft. 18 gauge



Available with K-123 "D" Spout  
Splash Mt. Wrist Handle Faucet  
**7-PS-46 \$3058**

For More A.D.A. Compliant  
Sinks, please see page 10.



**7-PS-65 \$1813**

Undermount Towel Dispenser  
with Skirt  
Deck Mounted Soap Dispenser  
K-22 Deck Mounted Faucet  
35 lbs. 10 cu. ft. 20 gauge

### 12" WIDE SPACE SAVER UNITS

Bowl Size: 9" x 9" x 5" • Overall Size: 16" x 12"

Includes 2" Drain With Flat Top Strainer & Wall Bracket



**7-PS-22 \$804**  
K-22 Deck Mounted Faucet  
12 lbs. 2 cu. ft. 20 gauge



**7-PS-23 \$840**  
K-123 Splash Mounted Faucet  
12 lbs. 2 cu. ft. 20 gauge



**7-PS-56 \$1286**  
K-123 Splash Mounted Faucet  
8" High Side Splashes  
14 lbs. 2 cu. ft. 20 gauge



**7-PS-88 \$1687**  
Undermount Towel Dispenser  
Deck Mt. Soap Dispenser  
K-22 Deck Mt. Faucet  
23 lbs. 10 cu. ft. 20 gauge



**7-PS-83 \$1577**  
Towel Dispenser  
Deck Mt. Soap Dispenser  
K-22 Deck Mt. Faucet  
27 lbs. 5 cu. ft. 20 gauge



**7-PS-84 \$1644**  
Towel Dispenser  
Deck Mt. Soap Dispenser  
K-123 Splash Mt. Faucet  
27 lbs. 5 cu. ft. 20 gauge



**7-PS-73 \$2080**  
7 3/4" High Side Splashes  
Towel Dispenser  
Deck Mt. Soap Dispenser  
K-123 Splash Mt. Faucet  
31 lbs. 5 cu. ft. 20 gauge

# HANDS-FREE

## Hand Washing Sinks

### HANDS-FREE ELECTRONIC OPERATED FAUCETS

Bowl Size: 10" x 14" x 5" • Overall Size: 15 1/4" x 17 1/4" Includes K-175 AC/DC Powered Electronic Operated Faucet



**7-PS-51 \$2366**

Equal to 7-PS-50 with K-175 Faucet  
21 lbs. 2 cu. ft. 20 gauge



**7-PS-61 \$2176**

Equal to 7-PS-60 with K-175 Faucet  
19 lbs. 2 cu. ft. 20 gauge



**7-PS-81 \$3256**

Equal to 7-PS-80 with K-175 Faucet  
32 lbs. 10 cu. ft. 20 gauge



**7-PS-91 \$3143**

Equal to 7-PS-90 with K-175 Faucet  
41 lbs. 10 cu. ft. 20 gauge

### KNEE VALVE OPERATED FAUCETS

Includes Single Knee Valve (With Built-In Mixing Valve), K-121 Splash Mt. Gooseneck Spout, Skirt, 3-1/2" Basket Drain (Otherwise Noted) & Wall Bracket



**7-PS-30 \$1710**

**Large Bowl Size**  
Bowl Size: 16" (F/B) x 14" x 6"  
Overall : 21-1/4" (F/B) x 17-1/4"  
33 lbs. 8 cu. ft. 18 gauge



**7-PS-62 \$1589**

**Standard Unit**  
Bowl Size: 10" x 14" x 5"  
Overall : 15-1/4" x 17-1/4"  
25 lbs. 2 cu. ft. 20 gauge



**7-PS-59 \$2054**

**Side Splash Unit**  
Bowl Size: 10" x 14" x 5"  
Overall : 15-1/4" x 17-1/4"  
7-3/4" Side Splashes  
31 lbs. 2 cu. ft. 20 gauge



**7-PS-63 \$1589**

**Spacesaver**  
1-1/2" Basket Drain  
Bowl Size: 9" x 9" x 5"  
Overall : 12-1/4" x 16"  
20 lbs. 8 cu. ft. 18 gauge



**7-PS-78 \$1982**

**Large Bowl Size**  
Bowl Size: 16" x 20" x 6"  
Overall : 24-3/4" x 21-7/8"  
40 lbs. 8 cu. ft. 18 gauge



All Sinks on this Page



All Sinks On This Page Ship Via UPS



**7-PS-82 \$2176**

**Towel & Soap Dispenser**  
Bowl Size: 10" x 14" x 5"  
Overall : 15-1/4" x 17-1/4"  
38 lbs. 6 cu. ft. 20 gauge

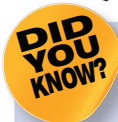

#### You Can Put A Skirt On Any Handsink

(Excludes sinks with existing bases or skirts. Sinks Not Included)

**7-PS-31 \$509**

Fits Hand Sinks with 10" x 14" Bowl and Splash Mounted Faucets

**7-PS-31A \$550**

Fits Hand Sinks with 9" x 9" Bowl Only

**7-PS-31B \$571**

Fits Hand Sinks with 10" x 14" Bowl and Deck Mounted Faucets

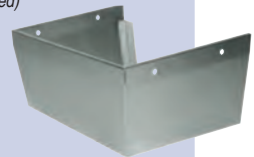

### KNEE & PEDAL VALVE REPLACEMENT PARTS & FAUCETS

#### Foot Pedal Valve Replacement

Combo. H/C  
Single Pedal

**K-103 \$456**

Foot Pedal with Retaining Pin Only

**K-17 \$114**



#### Knee Valve Replacement

Combo. H/C  
Single Pedal

**K-104 \$573**

Knee Pedal with Retaining Pin Only

**K-18 \$114**



#### Splash Mounted Gooseneck Spout

**K-121 \$134**

#### Replacement Check Valves



**K-19 \$23 set of 2**

#### Mixing Valve & Retainer



**K-19A \$18**

#### Foot Pedal Assembly w/Floor Bracket

**7-PS-39 \$612**



#### Knee Valve Assembly w/ Mounting Bracket

**7-PS-32 \$730**



#### Thermostatic Mixing Valve



**K-425 \$408**

#### Replacement Bonnet for Pedal/Knee Valve (K-103 & K-104, 7-PS-32 & 7-PS-39)



**K-01 \$47**



All Sinks on this Page



All Sinks On This Page Ship Via UPS

# HANDS-FREE Hand Washing Sinks

## FOOT PEDAL VALVE UNITS

Includes Single Pedal Valve (With Built-In Mixing Valve), K-121 Splash Mt. Gooseneck Spout, 3-1/2" Basket Drain & Wall Bracket, Removable Panel for Plumbing Access



### 7-PS-90 \$1637

#### Standard Unit

Bowl Size:  
10" x 14" x 5"  
Overall :  
17-1/4" x 15-1/4" x 42"  
41 lbs. 10 cu. ft. 20 gauge



### 7-PS-96 \$2083

#### Side Splash Unit

7-3/4" High Side Splashes  
Bowl Size:  
10" x 14" x 5"  
Overall :  
17-1/4" x 15-1/4" x 42"  
41 lbs. 10 cu. ft. 20 gauge



### 7-PS-18 \$1805

#### Large Bowl Size

Bowl Size:  
16" (F/B) x 14" x 6"  
Overall :  
21-1/4" (F/B) x 17-1/4" x 42"  
50 lbs. 11 cu. ft. 18 gauge



### 7-PS-86 \$2046

#### Extra Large Bowl Size

Bowl Size:  
16" x 20" x 8"  
Overall :  
24-3/4" (F/B) x 21-7/8" x 41-1/2"  
55 lbs. 16 cu. ft. 20 gauge



### 7-PS-99 \$2962

#### Towel & Soap Dispenser

Trash Receptacle  
Bowl Size:  
10" (F/B) x 14" x 5"  
Overall :  
17-1/4" (F/B) x 15-1/4" x 42"  
59 lbs. 15 cu. ft. 20 gauge



### 7-PS-95 \$2379

#### Towel & Soap Dispenser

Bowl Size:  
10" (F/B) x 14" x 5"  
Overall :  
17-1/4" (F/B) x 15-1/4" x 42"  
54 lbs. 15 cu. ft. 20 gauge



## You Can Put a Pedestal Base On Any Hand Sink

(Excludes Sinks With Existing Bases Or Skirts. Sinks Not Included)



### Basic Pedestal Base

#### 7-PS-37 \$570

For 10" x 14" Bowls

#### 7-PS-37B \$714

For 10" x 14" bowls and Deck Mounted Faucets

#### 7-PS-37C \$764

For 16" x 20" Bowls



### With Foot Valve

#### 7-PS-33 \$794

For 10" x 14" Bowls

#### 7-PS-33B \$1002

For 10" x 14" Bowls and Deck Mounted Faucets

#### 7-PS-33C \$1082

For 16" x 20" Bowls



### Add Trash Receptacle

#### 7-PS-29 \$647

Use above model number with any Pedestal Base Sink or Stand-Alone Pedestal Base.



Plastic Replacement Handles 7-PS-38 \$39

## SECURITY UNITS

Bowl Size: 10" x 14" x 5" • Require Minimum Security Installations  
Includes Heavy Duty Gooseneck Faucet, Concealed 3 1/2" Drain & Wall Bracket



### 7-PS-747 \$3217

Class 2 Upgrade  
45 lbs. 10 cu. ft. 20 gauge

### 7-PS-727 \$4088

Class 1 Upgrade  
Towel Dispenser  
Provisions For Installation Of Soap Dispenser (By Others)  
65 lbs. 15 cu. ft. 20 gauge



# HAND SINKS

## Hand Washing Sinks

All Sinks On This Page  
Ship Via UPS

**NSF** All Sinks on this Page

**DID YOU KNOW?**

You Can Add a K-175 or K-180 Electronic Faucet To Any Hand Sink \$1506  
(May require faucet hole revision. See Page 11.)



### CONCEALED HAND SINK DRAWER

Take Back Your Countertop Space!



- Easily Installs into Existing Advance Tabco Work Tables/Countertops or Integrates into Custom Fabrication
- Overall Size: 22 5/8" W x 19 7/8" L x 19 1/4" H
- 10" x 14" x 5" Deep Sink Bowl
- Pre-Drilled Holes In Flanges For Easy Mounting
- Integral Drawer Slides For Smooth Operation
- "Safety Stop" Tab
- K-50 Swing Spout Faucet
- 1-1/2" Sink Drain with Strainer Plate
- Drainage Pan with 1-1/2" Drain & Strainer Plate (Drain Pipe & Fittings Included.)



**7-PS-47 \$2600**

70 lbs. 7 cu. ft.  
18 gauge exterior  
16 gauge interior

### A.D.A. UNITS FOR THE PHYSICALLY CHALLENGED

Bowl Size: 16" x 14" x 5". Overall Size: 20" x 24" • Includes 1-1/2" Drain With Strainer Plate & Wall Bracket



**7-PS-77-E \$4408**

Tapered Bowl Design  
Hands Free Operated Faucet  
Deck Mount Soap Dispenser  
16 Gauge Skirt with Enclosed Bottom  
w/ Removable Access Panel  
65 lbs. 8 cu. ft. 18 gauge

**7-PS-77-W \$2858**

Same As Above with  
8" O.C. Wrist Handle Faucet



**7-PS-41 \$4608**

Tapered Bowl Design with  
Undermount Towel Dispenser  
Hands Free Operated Faucet  
Deck Mount Soap Dispenser  
16 Gauge Skirt with Enclosed Bottom  
w/ Removable Access Panel  
65 lbs. 8 cu. ft. 18 gauge

**7-PS-46 \$3058**

Same As Above with  
8" O.C. Wrist Handle Faucet



**7-PS-25 \$2079**

K-208 Deck Mounted Faucet  
with Wrist Handles  
Deck Mounted Soap Dispenser  
Wall Support Brackets  
25 lbs. 8 cu. ft. 18 gauge

**7-PS-75 \$1615**

Same As 7-PS-25 With  
8" O.C. Faucet Holes Only  
(Faucet Not Included)

**7-PS-26 \$3891**

Same As 7-PS-25 With  
K-180 Hands Free AC/DC  
Operated Faucet  
Deck Mounted Soap  
Dispenser



### COUNTERTOP INSTALLED HAND SINKS

- 4" High Side Splashes
- K-52 Deck Mounted Faucet
- Deck Mounted Soap Dispenser
- Built-In Towel Dispenser
- 3-1/2" Basket Drain



**7-PS-42 \$2665**

Bowl Size: 10" x 14" x 5"  
Overall Size: 18-1/4" x 17-5/8"  
30 lbs. 2 cu. ft. 20 gauge



**7-PS-42A \$2665**

Bowl Size: 9" x 9" x 5"  
Overall Size: 17-3/8" x 13"  
26 lbs. 2 cu. ft. 20 gauge

- 4" High Side Splashes
- Deck Mounted Gooseneck Spout
- Knee Operated Valve
- Deck Mounted Soap Dispenser
- Built-In Towel Dispenser
- 3-1/2" Basket Drain



Knee Valve Operated

**7-PS-43 \$3085**

Bowl Size: 10" x 14" x 5"  
Overall Size: 18-1/4" x 17-5/8"  
36 lbs. 2 cu. ft. 20 gauge

For Factory Installation, Add **TA-503 \$438**. Can Be Purchased Separately For In-Field Installation

### LARGE SIZE SINK BOWLS

Includes K-59 Splash Mt. Gooseneck Faucet,  
3-1/2" Basket Drain, Wall Bracket  
w/ 2 Support Brackets



**7-PS-45 \$1082**

Bowl Size: 16" x 20" x 8"  
Overall Size: 24 3/4" x " x 21 7/8"  
31 lbs. 8 cu. ft. 18 gauge

**7-PS-49 \$1011**

Bowl Size: 14" x 16" x 8"  
Overall Size: 19-1/4" x 19"  
30 lbs. 8 cu. ft. 18 gauge



**7-PS-55 \$1133**

Gooseneck Faucet  
w/ Eye Wash Attachment  
15 lbs. 3 cu. ft. 20 gauge



**7-PS-72 \$1157**

H.A.C.C.P. Compliant  
Slow Self-Closing Metering  
Faucet with Mixing Valve  
15 lbs. 3 cu. ft. 20 gauge

Overall Size:  
17-1/4" x 17-1/4"



**7-PS-64 \$1011**

Splash Mounted  
Gooseneck Faucet  
Tubular Support Brackets  
25 lbs. 2 cu. ft. 20 gauge

PATENTED  
DESIGN



**7-PS-44 \$2655**

Body Activated Valve  
K-121 Splash Mounted  
Gooseneck Spout  
28 lbs. 2 cu. ft. 18 gauge

Overall Size:  
15-1/4" x 17-1/4"



All Sinks on this Page

All Items On This Page Ship Via UPS

# HAND SINKS

## Hand Washing Sinks & Faucets

### FAUCETS OMITTED

Bowl Size: 10" x 14" x 5". Overall Size: 15 1/4" x 17 1/4"



**7-PS-70 \$569**  
Equal To 7-PS-60 Without Faucet



**7-PS-71 \$626**  
Equal To 7-PS-70 With Single Hole Punch



**7-PS-20-NF \$621**  
Equal To 7-PS-20 Without Faucet



**7-PS-66-NF \$1030**  
Equal To 7-PS-66 Without Faucet

### HAND SINK FAUCETS & SPOUTS



**Extra Heavy Duty Splash Mounted Faucet**  
**K-69 \$444**  
4" O.C.



**3-1/2" Splash Mounted Faucet**  
**K-59 \$221**  
4" O.C.

**3-1/2" Splash Mounted Faucet with Wrist Handles**

**K-316 \$339**  
4" O.C.

**Wrist Handles for Faucets**  
**K-316-LU \$114**



**3-1/2" Gooseneck Spouts**

**Deck Mount**  
**K-120 \$226**

**Splash Mounted**  
**K-121 \$134**



**Deck Mounted Faucet**



**K-22 \$200**  
4" O.C.

### ELECTRONIC HANDS FREE FAUCETS



**Splash Mt.**  
**K-175 \$1506**

**Deck Mt.**  
**K-180 \$1506**

Powered by AC or Battery!



**K-09 \$680**

**Infra-Red Sensor and Wire Assembly**



**K-14 \$112**

### "D" SPOUT EXTENDED FAUCETS



**Deck Mt. 6" Extended Spout**  
**K-124 \$326**  
4" O.C.



**Deck Mt. w/ Wrist Handles**  
**K-208 \$445**  
4" O.C.



**Splash Mt. 6" Extended Spout**  
**K-123 \$326**  
4" O.C.



**Splash Mt. w/ Wrist Handles**  
**K-206 \$425**  
4" O.C.

### SPECIALTY FAUCETS & ADAPTERS



**Slow-Released Metered Faucet**  
**K-190 \$549**



**Eye-Wash Attachment**  
**K-170 \$449**



**Hands-Free Wand**  
Spout Not Included  
**K-400 \$92 ea.**



**Low Flow Aerator .5 GPM**  
**K-08 \$26**

### REPLACEMENT CARTRIDGES WITH HANDLES\*

(Set of 2. Includes Cartridges and handles)

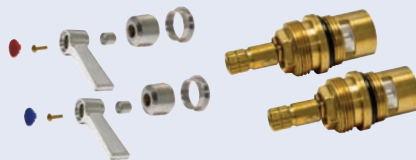

**For Faucets: K-59, K-123, K-125, K-126, K-206 & K-316**  
**K-00A \$103**

**For Faucets: K-1, K-11, K-50, K-51, K-52, K-53, K-56, K-124, K-101, K-159, K-160, K-208 & K-240**

**K-00B \$103**

\*Can Only Be Used On Faucets Purchased After January 2016. For Older Faucets, Consult Customer Service.

### REPLACEMENT FAUCET SPOUTS

Model #	Spout Size/Style	For Faucet Model	Price
K-52SP	3-1/2" Swivel Gooseneck	K-52	\$53
K-55SP	8-1/2" Swivel Gooseneck	K-55	85
K-59SP	3-1/2" Swivel Gooseneck	K-59	53
K-208SP	6" Extended Swivel Gooseneck	K-208	60
K-175SP	4-1/2" Swivel Gooseneck	K-175/K-180	53
K-50SP	8" Swing Spout	K-50	59
K-53SP	12" Swing Spout	K-53	79

### Faucet Hole Modifications

Faucet Hole Modification	Faucet Not Included
K-70 Punch for 8" O.C. Faucet Holes	\$126
K-70A Punch for Single Hole Splash Mt. Faucet	\$126
K-71 Punch for Single Hole Deck Mt. Faucet	\$126

# MODS & ACCESSORIES

## Hand Sink Modifications & Accessories

 = Ships Via UPS

### WELDED SIDE SPLASHES FOR HAND SINKS

Factory Installed Only



7-3/4" Side Splash Shown



Two 7-3/4" Welded Side Splashes Shown



Two 12" Welded Side Splashes Shown

Shown with Optional Utility Tray



Two 24" Welded Side Splashes & Back Panel Shown

7-3/4" HEIGHT SPLASH		12" HEIGHT SPLASH		24" HEIGHT SPLASH 		Description				
1 Side Splash Model #	Price	2 Side Splashes Model #	Price	2 Side Splashes & Rear Panel* Model #	Price					
7-PS-16	\$355	7-PS-17	\$452	7-PS-11	\$432	7-PS-15	\$487	7-PS-28	\$1100	Units w/ 10" x 14" Bowl & Splash Mount Faucet
7-PS-16A	355	7-PS-17A	463	7-PS-11A	432	7-PS-15A	487	7-PS-28A	1100	Units w/ 9" x 9" Bowls
7-PS-16B	377	7-PS-17B	497	7-PS-11B	465	7-PS-15B	519	7-PS-28B	1110	Units w/ 10" x 14" Bowl & Deck Mount Faucet
7-PS-16C	387	7-PS-17C	518	7-PS-11C	487	7-PS-15C	538	7-PS-28C	1175	Units w/ 16" x 20" Bowls
7-PS-16D	419	7-PS-17D	542	7-PS-11D	526	7-PS-15D	599	7-PS-28D	1200	For Handicapped Hand Sinks
7-PS-16E	382	7-PS-17E	507	7-PS-11E	516	7-PS-15E	587	7-PS-28E	1145	Units w/ 14" (F/B) x 16" Bowls
7-PS-16F	382	7-PS-17F	507	7-PS-11F	516	7-PS-15F	587	7-PS-28F	1155	Units w/ 16" (F/B) x 14" Bowls

\*24" high splashes include a rear panel that matches the height of the side splashes. Only available as 2 side design. Single side not offered. Includes rear mounting holes.

### BOLT-ON SINGLE PANEL SPLASH FOR HAND SINKS

 All Bolt-On Splashes Ship Via UPS

#### 7-3/4" & 12" Height Bolt-On Splash

(Priced Per Splash. Order 2 for Both Sides)



Includes Holes. Hardware not Included

7-3/4" HEIGHT SPLASH		12" HEIGHT SPLASH		Description
Model #	Price Ea.	Model #	Price Ea.	
7-PS-27	\$172	7-PS-13	\$223	Units w/ 10" x 14" Bowl & Splash Mount Faucet
7-PS-27A	172	7-PS-13A	223	Units w/ 9" x 9" Bowls
7-PS-27B	172	7-PS-13B	248	Units w/ 10" x 14" Bowl & Deck Mount Faucet
7-PS-27C	172	7-PS-13C	257	Units w/ 16" x 20" Bowls
7-PS-27D	196	7-PS-13D	238	For Handicapped Hand Sinks
7-PS-27E	219	7-PS-13E	236	Units w/ 14" (F/B) x 16" Bowls
7-PS-27F	219	7-PS-13F	236	Units w/ 16" (F/B) x 14" Bowls



7-PS-25 Shown With Optional Side Splashes.

#### Removable Utility Tray for Side Splashes

- 8" X 3" X 2 5/16" Tray.
- Tray Hem Allows To Hang From Any Standard Side Splash.
- Perforated For Water Drainage.

7-PS-48 \$295 



#### Side Mounting Wall Brackets

Includes 2 brackets. Used for Added Strength & Support (Add to price of sink)

7-PS-36 \$132 



#### Tubular Wall Supports



Set of 2 Supports

Model #	Price	Description
7-PS-24	\$427	Units w/ 10"x14" Bowl & Splash Mt. Faucet
7-PS-24B	427	Units w/ 10"x14" Bowl & Deck Mt. Faucet
7-PS-24C	500	Units with 16"x14" & 16"x20" Bowls

# MODS & ACCESSORIES

## Hand Sink Modifications & Accessories

 = Ships Via UPS

### Instant Hot Water ON DEMAND

This unit allows for hand sinks to be installed in remote areas with just a cold water supply and available 30 amp electric power. There is no delay or wasted water while waiting for hot water to reach the faucet. Includes Heater & Plumbing Hardware.

7-PS-92 \$2197 

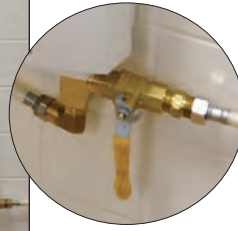

Only 1 Single Supply Line Of Cold Water Is Required To Feed The Unit!

**HANDSINK NOT INCLUDED**

 All items Below Ship Via UPS

### SOAP & TOWEL DISPENSERS



**C-Fold Style Paper Towel & Soap Dispenser**  
Mounts On 17" Wide Hand Sinks Only

7-PS-34 \$1034



**Wall Mounted Paper Towel Dispenser**

7-PS-35 \$317



**Wall Mounted Liquid Soap Dispenser**

7-PS-12 \$172



**Wall Mt. Liquid Soap Dispenser**  
Stainless Steel

K-13 \$392



**Deck Mounted Liquid Soap Dispenser**

K-12 \$144

### DRAINS, PARTS & P-TRAPS



1-1/2" IPS

**3-1/2" Basket Drain Assembly**

K-6 \$44



1-1/2" IPS

**2" Drain Assembly w/ Strainer Plate**

K-63 \$36



**Drain Basket For K-6**

K-310 \$27

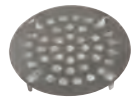

**Replacement Strainer Plates**

for 3-1/2" Drain for 2" Drain  
K-410 \$24 K-411 \$22



1-1/2" IPS

**Standard Chrome Plated P-Traps**

22 Gauge  
7-PS-14 \$113

17 Gauge  
7-PS-10 \$128



**Replacement Washers for 3-1/2" Drains**

K-67F \$13 (Set of 2)



**K-26 \$153**  
Lever Drain with P-Trap & Overflow

**K-67 \$153**  
Lever Drain Without Overflow

#### REPLACEMENT PARTS FOR K-26 DRAIN



Model #	Description	Price
K-67A	Tail Piece with Overflow Branch Only	\$26
K-67B	Overflow Hose with 2 Spring Clips	16
K-67C	Plastic 90° Overflow Head & Body	13
K-67D	Lever Handle for K-26 Drain	14
K-67E	Plastic Stopper (Includes "O" Ring)	13

# MOP SINKS

## Floor Mop Sinks



 = Ships Via UPS

**CUSTOM SIZES AVAILABLE**



9-OP-20 Shown

### FLOOR UNITS Mounting Hardware Included

Model #	Bowl Size	Overall Dimension	Price	Approx. Wt.	Approx. Cu.
<b>STANDARD MOP SINKS</b> <small>NSF</small>					
9-OP-20	16" x 20" x 6"	21" x 25"	<b>\$1381</b>	33 lbs.	4 
9-OP-28	20" x 28" x 6"	25" x 33"	<b>1788</b>	47 lbs.	7 
9-OP-40	16" x 20" x 12"	21" x 25"	<b>1657</b>	45 lbs.	6 
9-OP-48	20" x 28" x 12"	25" x 33"	<b>1955</b>	62 lbs.	9
<b>LARGE MOP SINK BOWL</b>					
9-OP-44	24" x 24" x 12"	29" x 29"	<b>2451</b>	70 lbs.	9
<b>DROP-FRONT MOP SINKS</b>					
9-OP-40DF	16" x 20" x 12"	18 1/2" x 25"	<b>2612</b>	85 lbs.	9
9-OP-48DF	20" x 28" x 12"	22 1/2" x 33"	<b>2907</b>	110 lbs.	15



9-OP-40DF Shown



Notched Out Front Allows Ease of Emptying Mop Bucket

### Flush-Mount Floor Mop Sink

- Easy Mop Bucket Roll-In Design
- Standard Backsplash with Left & Right Splash, Left Splash or Right Splash Available
- 4" O.D. - 3" Long Plumbing Sleeve
- Front Anti-Splash Guard
- Removable Subway Grating
- Stainless Steel Strainer Basket with Handle

**FT-2 \$58 ea.**  
Replacement Stainless Steel Strainer Basket with Handle for Flush-Mount Floor Mop Sinks



9-OP-24FM-SSRL Shown



WITH STAINLESS STEEL GRATES			WITH FIBERGLASS GRATES			Bowl Size	Overall Dimension	Splash Locations	Approx. Cu.
Model #	Approx. Wt.	Price	Model #	Approx. Wt.	Price				
9-OP-24FM-SSRL	128 lbs.	<b>\$4411</b>	9-OP-24FM-FGRL	96 lbs.	<b>\$4411</b>	21 3/8" x 22 x 10"	21 3/8" x 24"	Back, Left & Right	14
9-OP-24FM-SSL	120 lbs.	<b>4261</b>	9-OP-24FM-FGL	88 lbs.	<b>4261</b>	21 3/8" x 22 x 10"	21 3/8" x 24"	Back & Left	14
9-OP-24FM-SSR	120 lbs.	<b>4261</b>	9-OP-24FM-FGR	88 lbs.	<b>4261</b>	21 3/8" x 22 x 10"	21 3/8" x 24"	Back & Right	14

**DID YOU KNOW?**



You Can Use a K-610 Removable Stainless Steel Sink Grid In A Floor Mop Sink **\$706**





### 16" HIGH SIDE & BACK SPLASHES FOR FLOOR MOP SINKS

16 Gauge, 300 Series Stainless Steel

#### Splashes on All 3 Sides

Model #	Fits Units:	Model #	Fits Units:	Price
K-298	9-OP-20 9-OP-40	K-298D	9-OP-40DF	<b>\$941</b> 
K-299	9-OP-28 9-OP-48	K-299D	9-OP-48DF	<b>1031</b> 
K-300	9-OP-44	-	-	<b>1220</b> 

#### Splash on Left or Right & Back

Model #	Fits Units:	Model #	Fits Units:	Price
K-288LorR	9-OP-20 9-OP-40	K-288LorRD	9-OP-40DF	<b>\$597</b> 
K-290LorR	9-OP-28 9-OP-48	K-290LorRD	9-OP-48DF	<b>632</b> 
K-291LorR	9-OP-44	-	-	<b>867</b> 



Left & Right Splashes Shown

Height Above Finished Floor (A.F.F.)

9-OP-20/9-OP-28 = 26" High 9-OP-40/9-OP-40DF/9-OP-44/9-OP-48/ 9-OP-48DF = 32" High

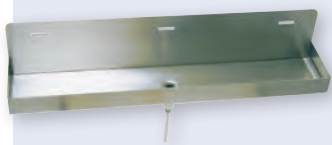

#### Wall Mounted Drainage Tray K-243 \$485

- Used with Floor Mounted Mop Sinks
- 16 Gauge, 300 Series Stainless Steel
- Includes 1/2" Drain & Plastic Hose
- 2" Tray Ht. with 6" Rear Splash (O.A.)
- 20" x 4" x 6". 13 lbs.



**Hose & Hanger**  
K-244 **\$201**



**23" Mop Hanger**  
K-242 **\$219**



4-OP-18

**Fabricated Sink Bowl**



8-OP-16

**Deep Drawn Sink Bowl**

### STANDING SERVICE SINKS

Heavy Gauge Stainless Steel • 8" Bowl Depth • 8" High Backsplash • Stainless Steel Legs with Adjustable Bullet Feet  
• 8-OP-16 Includes Stainless Steel Cross-Bracing • 8" O.C. Faucet Holes • 3-1/2" Basket Drain

Model #	Bowl Size	Overall Dimension	Price	Approx. Wt.	Approx. Cu.
8-OP-16	16" x 20" x 8"	25" x 23"	<b>\$1524</b>	50 lbs.	13 
4-OP-18	24" x 21" x 8"	24" x 25"	<b>1040</b>	50 lbs.	10



# MOP SINKS

## Mop Sink Cabinets

84" HIGH STAINLESS STEEL MOP SINK CABINETS  = Ships Via UPS



### Single Width

- Single Left-Hinged Door\*
- 1 Fixed Stainless Steel Mid-Shelf
- Ventilation Slots
- 2 Mop Holders
- Open Back For Plumbing
- 16 Ga., Type 304 S/S Mop Sink & Drain

16" x 20" x 12" Bowl  
Overall Size: 22-5/8" x 25" x 84"



### Double Width



- Hinged Double Doors
- Opening For Mop Bucket To Roll In
- 4 Fixed Stainless Steel Mid-Shelves (3 In Storage Side, 1 Above Sink)
- Enclosed Back Panel
- Ventilation Slots
- 2 Mop Holders
- Open Back For Plumbing
- 16 Ga., Type 304 S/S Mop Sink & Drain

16" x 20" x 12" Bowl  
Overall Size: 22-5/8" x 50-1/4" x 84"

9-OPC-84DR Shown

Model #	Cabinet Material	Price	Approx. Wt.	Approx. Cu.
9-OPC-84	18 Ga., 430 S/S	\$6846	238 lbs.	40
9-OPC-84-300	18 Ga., 300 S/S	7987	238 lbs.	40

\*Optional Right-Hand Door Swing Available - Add CAB-R N/C

Model #	Cabinet Material	Price	Approx. Wt.	Approx. Cu.
9-OPC-84DR	18 Ga., 430 S/S	\$9357	390 lbs.	72
9-OPC-84DL	18 Ga., 430 S/S	9357	390 lbs.	72
9-OPC-84DR-300	18 Ga., 300 S/S	9812	390 lbs.	72
9-OPC-84DL-300	18 Ga., 300 S/S	9812	390 lbs.	72

R And L Indicates Mop Sink Location.

### Stainless Steel Cabinet with Floor

Sink Not Included

- Overall Size: 22-5/8" x 25" x 84"
- Single Left-Hinged Door\*
- Fixed Stainless Steel Mid-Shelves
- Enclosed Back Panel
- Ventilation Slots On Both Sides

Model #	# of Fixed Shelves	Price	Approx. Wt.	Approx. Cu.
18 Ga. CAB-1	1	\$5020	200 lbs.	40
430 S/S CAB-4	4	5819	240 lbs.	40
18 Ga. CAB-1-300	1	5477	200 lbs.	40
300 S/S CAB-4-300	4	6389	240 lbs.	40

\*Optional Right-Hand Door Swing Available - Add CAB-R N/C



### CHEMICAL STORAGE CABINET

w/ 1 Fixed Stainless Steel Mid-Shelf



Vented Side Panels

WCH-15-24 Left Hinged Shown (Standard)

- Left-Hinged Door\*
- Vented Side Panels
- Wall Mounting Hardware Not Included

**WCH-15-24 \$4222**

18 Gauge, 430 Stainless Steel

**WCH-15-24-300 \$4678**

18 Gauge, 300 Stainless Steel

\*Optional Right-Hand Door Swing Available - Add CAB-R N/C

Overall Size: 15" x 24" x 32-1/2"

## MOP SINK CABINET ACCESSORIES & MODIFICATIONS



### Service Faucet For Mop Sinks

8" O.C.

**K-240\* \$877** 

\*K-240 Does Not Meet Federal Lead Free Standards As It Is Not Intended For Potable Water.



### Service Faucet Vacuum Breaker Repair Kit

**K-03 \$122** 



### Mop Sink Replacement Drain

**K-16 \$169** 

### Double Cabinet Doors

Convert Single Width Cabinet to Double Doors

**K-84-CAB \$673**



### Add Rear Panel To Cabinet

**K-94-BACK \$463**

**K-94-BACK-300 \$670**

Add **K-472** for 8" O.C. Faucet Holes \$121 Per Hole



### Additional Fixed Mid-Shelf

**K-94-SHELF \$355 ea.**

For 84" High Cabinets

**WC-SHELF \$86 lin. ft.**

For Wall Cabinets

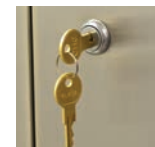

### Cabinet Door Lock

**SU-27 \$286**

Required For Each Hinged Door

# MULTI-STATIONS

## NSF Multi-Stations



= Ships Via UPS

### 14 GAUGE, 304 STAINLESS STEEL SINKS WITH TUBULAR SUPPORTS OR LEGS

8" Bowl Depth • 8 1/2" High Backsplash • 8" O.C. Faucet Holes on Manual Operated, Single Holes on Knee or Electronic Operated • 3 1/2" Basket Drain(s)

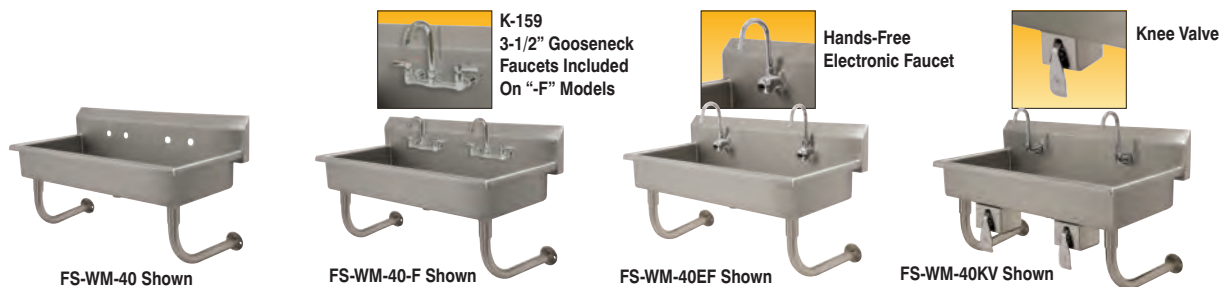

L	NO FAUCETS INCLUDED		MANUAL FAUCETS INCLUDED		ELECTRONIC OPERATED FAUCETS		KNEE OPERATED FAUCETS		# of Faucets	Wt.	Cu. Ft.
	Model #	Price	Model #	Price	Model #	Price	Model #	Price			
40"	FS-WM-40 <sup>†</sup>	\$4091	FS-WM-40-F <sup>†</sup>	\$4586	FS-WM-40EF	\$6421	FS-WM-40KV	\$5357	2	72 lbs.	15
60"	FS-WM-60 <sup>†</sup>	4550	FS-WM-60-F <sup>†</sup>	5293	FS-WM-60EF	8039	FS-WM-60KV	6444	3	84 lbs.	18
80"	FS-WM-80 <sup>†</sup>	5158	FS-WM-80-F <sup>†</sup>	6149	FS-WM-80EF	9810	FS-WM-80KV	7683	4	120 lbs.	22
100"	FS-WM-100 <sup>†</sup>	5656	FS-WM-100-F <sup>†</sup>	6895	FS-WM-100EF	11472	FS-WM-100KV	8814	5	156 lbs.	30
120"	FS-WM-120 <sup>†</sup>	7132	FS-WM-120-F <sup>†</sup>	8618	FS-WM-120EF	14111	FS-WM-120KV	10920	6	198 lbs.	36

<sup>†</sup>Add K-472 For Faucet Hole Revision \$121



### 14 GAUGE, 304 STAINLESS STEEL A.D.A. SINKS WITH TUBULAR SUPPORTS

5" Bowl Depth • 8 1/2" High Backsplash • 8" O.C. Faucet Holes on Manual Operated or Single Holes on Electronic Faucet Operated • Rear 3 1/2" Basket Drain(s)

L	NO FAUCETS INCLUDED		MANUAL FAUCETS INCLUDED		ELECTRONIC OPERATED FAUCETS		# of Faucets	Wt.	Cu. Ft.
	Model #	Price	Model #	Price	Model #	Price			
40"	FS-WM-40-ADA <sup>†</sup>	\$4091	FS-WM-40-ADA-F <sup>†</sup>	\$4680	FS-WM-40EFADA	\$6297	2	72 lbs.	15
60"	FS-WM-60-ADA <sup>†</sup>	4550	FS-WM-60-ADA-F <sup>†</sup>	5480	FS-WM-60EFADA	7904	3	84 lbs.	18
80"	FS-WM-80-ADA <sup>†</sup>	5158	FS-WM-80-ADA-F <sup>†</sup>	6422	FS-WM-80EFADA	9655	4	120 lbs.	22
100"	FS-WM-100-ADA <sup>†</sup>	5656	FS-WM-100-ADA-F <sup>†</sup>	7262	FS-WM-100EFADA	11303	5	156 lbs.	30
120"	FS-WM-120-ADA <sup>†</sup>	7132	FS-WM-120-ADA-F <sup>†</sup>	9146	FS-WM-120EFADA	13995	6	198 lbs.	36

<sup>†</sup>Add K-472 For Faucet Hole Revision \$121



FS-WM-40EFADA Shown

### 16 GAUGE, 304 STAINLESS STEEL SINKS WITH TUBULAR SUPPORTS OR LEGS

8" Bowl Depth • 8 1/2" High Backsplash • 8" O.C. Faucet Holes on Manual Operated, Single Holes on Knee or Electronic Operated • 3 1/2" Basket Drain(s)

L	NO FAUCETS INCLUDED		MANUAL FAUCETS INCLUDED		ELECTRONIC OPERATED FAUCETS		KNEE OPERATED FAUCETS		# of Faucets	Wt.	Cu. Ft.
	Model #	Price	Model #	Price	Model #	Price	Model #	Price			
40"	FC-WM-40 <sup>†</sup>	\$3537	FC-WM-40-F <sup>†</sup>	\$4033	FC-WM-40EF	\$5863	FC-WM-40KV	\$4800	2	66 lbs.	15
60"	FC-WM-60 <sup>†</sup>	3993	FC-WM-60-F <sup>†</sup>	4737	FC-WM-60EF	7483	FC-WM-60KV	5887	3	77 lbs.	18
80"	FC-WM-80 <sup>†</sup>	4678	FC-WM-80-F <sup>†</sup>	5669	FC-WM-80EF	9330	FC-WM-80KV	7204	4	110 lbs.	22
100"	FC-WM-100 <sup>†</sup>	5249	FC-WM-100-F <sup>†</sup>	6488	FC-WM-100EF	11064	FC-WM-100KV	8405	5	143 lbs.	30
120"	FC-WM-120 <sup>†</sup>	6276	FC-WM-120-F <sup>†</sup>	7763	FC-WM-120EF	13254	FC-WM-120KV	10064	6	182 lbs.	36

<sup>†</sup>Add K-472 For Faucet Hole Revision \$121



### 16 GAUGE, 304 STAINLESS STEEL A.D.A. SINKS WITH TUBULAR SUPPORTS

5" Bowl Depth • 8 1/2" High Backsplash • 8" O.C. Faucet Holes on Manual Operated or Single Holes on Electronic Faucet Operated • Rear 3 1/2" Basket Drain(s)

L	NO FAUCETS INCLUDED		MANUAL FAUCETS INCLUDED		ELECTRONIC OPERATED FAUCETS		# of Faucets	Wt.	Cu. Ft.
	Model #	Price	Model #	Price	Model #	Price			
40"	FC-WM-40-ADA <sup>†</sup>	\$3537	FC-WM-40-ADA-F <sup>†</sup>	\$4178	FC-WM-40EFADA	\$5795	2	66 lbs.	15
60"	FC-WM-60-ADA <sup>†</sup>	3993	FC-WM-60-ADA-F <sup>†</sup>	4944	FC-WM-60EFADA	7369	3	77 lbs.	18
80"	FC-WM-80-ADA <sup>†</sup>	4678	FC-WM-80-ADA-F <sup>†</sup>	5870	FC-WM-80EFADA	9102	4	110 lbs.	22
100"	FC-WM-100-ADA <sup>†</sup>	5249	FC-WM-100-ADA-F <sup>†</sup>	6909	FC-WM-100EFADA	10950	5	143 lbs.	30
120"	FC-WM-120-ADA <sup>†</sup>	6276	FC-WM-120-ADA-F <sup>†</sup>	8291	FC-WM-120EFADA	13140	6	182 lbs.	36

<sup>†</sup>Add K-472 For Faucet Hole Revision \$121



FC-WM-40-ADA Shown

 = Ships Via UPS



# SERVICE SINKS

## NSF Service Sinks

### 14 GAUGE, 304 STAINLESS STEEL SERVICE SINKS WITH TUBULAR SUPPORTS OR LEGS

10" or 12" Bowl Depth • 8-1/2" High Backsplash • 8" O.C. Faucet Holes on Manual Operated, Single Holes on Knee or Electronic Operated • 3 1/2" Basket Drain(s)



NO FAUCET INCLUDED		<b>new</b> MANUAL FAUCET INCLUDED	ELECTRONIC OPERATED FAUCET		KNEE OPERATED FAUCET		Bowl Depth	L	W	Wt.	Cu. Ft.	
Model #	Price	Model #	Price	Model #	Price	Model #						Price
FS-WM-2219 <sup>†</sup>	\$2209	FS-WM-2219-F <sup>†</sup>	\$2378	FS-WM-2219EF	\$3372	FS-WM-2219KV*	\$2840	10"	23"	19 1/2"	62 lbs.	10
FS-WM-2721 <sup>†</sup>	2350	FS-WM-2721-F <sup>†</sup>	2512	FS-WM-2721EF	3512	FS-WM-2721KV*	2981	12"	27"	21 1/2"	77 lbs.	13

<sup>†</sup>Add **K-472** For Faucet Hole Revision **\$121**

\*FS-WM-2219KV & FS-WM-2721KV Has 8" Bowl Depth



### 14 GAUGE, 304 STAINLESS STEEL A.D.A. SERVICE SINKS WITH TUBULAR SUPPORTS

5" Bowl Depth • 8-1/2" High Backsplash • Stainless Steel Tubular Supports • 8" O.C. Faucet Holes on Manual Operated, Single Hole on Electronic Operated • 3 1/2" Basket Drain

NO FAUCET INCLUDED		<b>new</b> MANUAL FAUCET INCLUDED	ELECTRONIC OPERATED FAUCET		Bowl Depth	L	W	Wt.	Cu. Ft.
Model #	Price	Model #	Price	Model #					
FS-WM-1-ADA <sup>†</sup>	\$3657	FS-WM-1-ADA-F <sup>†</sup>	\$3821	FS-WM-1-EFADA	6"	40"	19-1/2"	72 lbs.	15

<sup>†</sup>Add **K-472** For Faucet Hole Revision **\$121**



FS-WM-1-EFADA Shown

### 16 GAUGE, 304 STAINLESS STEEL SERVICE SINKS WITH TUBULAR SUPPORTS OR LEGS

10" or 12" Bowl Depth • 8-1/2" High Backsplash • 8" O.C. Faucet Holes on Manual Operated, Single Holes on Knee or Electronic Operated • 3 1/2" Basket Drain(s)



NO FAUCET INCLUDED		<b>new</b> MANUAL FAUCET INCLUDED	ELECTRONIC OPERATED FAUCET		KNEE OPERATED FAUCET		Bowl Depth	L	W	Wt.	Cu. Ft.	
Model #	Price	Model #	Price	Model #	Price	Model #						Price
FC-WM-2219 <sup>†</sup>	\$1961	FC-WM-2219-F <sup>†</sup>	\$2249	FC-WM-2219EF	\$3125	FC-WM-2219KV*	\$2594	10"	23"	19 1/2"	57 lbs.	10
FC-WM-2721 <sup>†</sup>	2065	FC-WM-2721-F <sup>†</sup>	2353	FC-WM-2721EF	3228	FC-WM-2721KV*	2696	12"	27"	21 1/2"	70 lbs.	13

<sup>†</sup>Add **K-472** For Faucet Hole Revision **\$121**

\*FC-WM-2219KV & FC-WM-2721KV Has 8" Bowl Depth



### 16 GAUGE, 304 STAINLESS STEEL A.D.A. SERVICE SINKS WITH TUBULAR SUPPORTS

5" Bowl Depth • 8-1/2" High Backsplash • Stainless Steel Tubular Supports • 8" O.C. Faucet Holes on Manual Operated, Single Hole on Electronic Operated • 3 1/2" Basket Drain

NO FAUCET INCLUDED		<b>new</b> MANUAL FAUCET INCLUDED	ELECTRONIC OPERATED FAUCET		Bowl Depth	L	W	Wt.	Cu. Ft.
Model #	Price	Model #	Price	Model #					
FC-WM-1-ADA <sup>†</sup>	\$3468	FC-WM-1-ADA-F <sup>†</sup>	\$3823	FC-WM-1-EFADA	5"	40"	19 1/2"	62 lbs.	15

<sup>†</sup>Add **K-472** For Faucet Hole Revision **\$121**



FC-WM-1-ADA Shown

**WARNING:** Equipment that include faucets on this page may contain a chemical known to the State of California to cause cancer, birth defects or other reproductive harm.

# MULTI-STATIONS

## Square Corner Multi-Stations

 = Ships Via UPS

### 16 GAUGE, 304 STAINLESS STEEL MULTI-STATIONS WITH TUBULAR SUPPORTS OR LEGS

8" Bowl Depth • 8 1/2" High Backsplash • 8" O.C. Faucet Holes on Manual Operated, Single Holes on Knee or Electronic Operated • 3 1/2" Basket Drain(s)



L	NO FAUCETS INCLUDED		MANUAL FAUCETS INCLUDED 		ELECTRONIC OPERATED FAUCETS		KNEE OPERATED FAUCETS		# of Faucets	Wt.	Cu. Ft.
	Model #	Price	Model #	Price	Model #	Price	Model #	Price			
23"	19-18-23 <sup>†</sup>	\$1776	19-18-23-F	\$2023	19-18-23EF	\$3005	19-18-23KV	\$2474	1	50 lbs.	10
40"	19-18-40 <sup>†</sup>	2854	19-18-40-F	3350	19-18-40EF	5180	19-18-40KV	4116	2	60 lbs.	15
60"	19-18-60 <sup>†</sup>	3372	19-18-60-F	4115	19-18-60EF	6862	19-18-60KV	5266	3	70 lbs.	18
80"	19-18-80 <sup>†</sup>	3760	19-18-80-F	4751	19-18-80EF	8413	19-18-80KV	6285	4	90 lbs.	22
100"	19-18-100 <sup>†</sup>	4279	19-18-100-F	5518	19-18-100EF	10095	19-18-100KV	7436	5	120 lbs.	30
120"	19-18-120 <sup>†</sup>	5352	19-18-120-F	6839	19-18-120EF	12330	19-18-120KV	9140	6	155 lbs.	36

<sup>†</sup>Add **K-472** For Faucet Hole Revision **\$121**



### 16 GAUGE, 304 STAINLESS STEEL A.D.A. MULTI-STATIONS WITH TUBULAR SUPPORTS

5" Bowl Depth • 8 1/2" High Backsplash • 8" O.C. Faucet Holes on Manual Operated or Single Holes on Electronic Faucet Operated • Rear 3 1/2" Basket Drain(s)



L	NO FAUCETS INCLUDED		MANUAL FAUCETS INCLUDED 		ELECTRONIC OPERATED FAUCETS		# of Faucets	Wt.	Cu. Ft.
	Model #	Price	Model #	Price	Model #	Price			
40"	19-18-40-ADA <sup>†</sup>	\$2854	19-18-40-ADA-F	\$3564	19-18-40EFADA	\$5180	2	60 lbs.	15
60"	19-18-60-ADA <sup>†</sup>	3372	19-18-60-ADA-F	4436	19-18-60EFADA	6817	3	70 lbs.	18
80"	19-18-80-ADA <sup>†</sup>	3760	19-18-80-ADA-F	5180	19-18-80EFADA	8413	4	100 lbs.	22
100"	19-18-100-ADA <sup>†</sup>	4279	19-18-100-ADA-F	6053	19-18-100EFADA	10095	5	130 lbs.	30
120"	19-18-120-ADA <sup>†</sup>	5352	19-18-120-ADA-F	7481	19-18-120EFADA	12330	6	165 lbs.	36

<sup>†</sup>Add **K-472** For Faucet Hole Revision **\$121**

# SERVICE SINKS

## Square Corner Service Sinks

### 16 GAUGE, 304 STAINLESS STEEL SERVICE SINKS WITH TUBULAR SUPPORTS OR LEGS

12" Bowl Depth (Excludes Knee Valve Units\*) • 8 1/2" High Backsplash • 8" O.C. Faucet Holes on Manual Operated, Single Holes on Knee or Electronic Operated • 3 1/2" Basket Drain(s)



NO FAUCET INCLUDED		<b>new</b> MANUAL FAUCET INCLUDED	ELECTRONIC OPERATED FAUCETS		KNEE OPERATED FAUCETS		L	W	Wt.	Cu. Ft.	
Model #	Price	Model #	Price	Model #	Price	Model #	Price				
WSS-14-21 <sup>†</sup>	\$1868	WSS-14-21-F	\$2116	WSS-14-21EF	\$3030	WSS-14-21KV*	\$2499	18"	17 1/2"	45 lbs.	8
WSS-16-25 <sup>†</sup>	2062	WSS-16-25-F	2310	WSS-16-25EF	3226	WSS-16-25KV*	2694	22"	19 1/2"	52 lbs.	10

<sup>†</sup>Add **K-472** For Faucet Hole Revision **\$121**

\*Knee Valve Unit Has 8" Bowl Depth



### 16 GAUGE, 304 STAINLESS STEEL A.D.A. SERVICE SINKS WITH TUBULAR SUPPORTS

5" Bowl Depth • 8 1/2" High Backsplash • 8" O.C. Faucet Holes on Manual Operated, Single Holes on Electronic Operated • Rear 3 1/2" Basket Drain



NO FAUCET INCLUDED		<b>new</b> MANUAL FAUCET INCLUDED	ELECTRONIC OPERATED FAUCETS		L	W	Wt.	Cu. Ft.
Model #	Price	Model #	Price	Model #	Price			
19-18-1-ADA <sup>†</sup>	\$2852	19-18-1-ADA-F	\$3207	19-18-1-EFADA	\$3960	40"	19 1/2"	60 lbs. 15

<sup>†</sup>Add **K-472** For Faucet Hole Revision **\$121**

### MULTI-STATION HAND SINK ACCESSORIES & MODIFICATIONS



Model	Description	Price	Model	Description	Price
K-6	3 1/2" Drain (1 1/2" I.P.S.)	\$44 ea.	K-411	Strainer Plate for 3-1/2" Drain	22 ea.
K-13	Stainless Steel Soap Dispenser	392 ea.	K-1118	Extra H.D. 8" Splash Mounted Faucet	366 ea.
K-101	8" Swing Spout Splash Mt. Faucet	215 ea.	K-316-LU	Wrist Handles	114 pair
K-121	Single Hole, Splash Mounted 3-1/2" Gooseneck Spout	134 ea.	K-472	Faucet Hole Revision (Manual Faucet Operated Sinks Only)	121
K-159	Splash Mounted 3-1/2" Gooseneck Faucet (8" O.C.)	248 ea.	K-508	Special Sizing Charge (Larger Size Cut Down To Smaller Size)	N/C
K-161-LU	Splash Mounted 3-1/2" Gooseneck Faucet (8" O.C.) With Wrist Handles	355 ea.	TA-19	Adjustable Stainless Steel Flanged Bullet Foot	56 ea.

**WARNING:** Equipment that includes a faucet may expose you to chemicals, including lead, that are known to the State of California to cause cancer or birth defects or other reproductive harm. For more info., visit [www.p65warnings.ca.gov](http://www.p65warnings.ca.gov).

# MULTI-STATIONS

## NSF Multi-Stations



= Ships Via UPS

### 14 GA., 304 STAINLESS STEEL SINKS W/STAINLESS STEEL LEGS & FLANGED FEET

8" Bowl Depth • 8 1/2" High Backsplash • 8" O.C. Faucet Holes on Manual Operated, Single Holes on Knee/Toe-Push or Electronic Operated  
 • Stainless Steel Flanged Feet • Wall Support Bracket • Side & Rear Cross-Bracing • 3 1/2" Basket Drain(s)



FS-FM-40 Shown



FS-FM-40-F Shown



FS-FM-40EF Shown



FS-FM-40KV Shown



FS-FM-40FV Shown

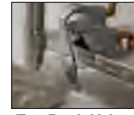

Toe-Push Valve

L	NO FAUCETS INCLUDED		MANUAL FAUCETS INCLUDED		ELECTRONIC OPERATED FAUCETS		KNEE OPERATED FAUCETS		TOE-PUSH OPERATED FAUCETS		# of Faucets	Wt.	Cu. Ft.
	Model #	Price	Model #	Price	Model #	Price	Model #	Price	Model #	Price			
40"	FS-FM-40 <sup>†</sup>	\$4507	FS-FM-40-F	\$5002	FS-FM-40EF	\$6837	FS-FM-40KV	\$5773	FS-FM-40FV	\$6088	2	72 lbs.	15
60"	FS-FM-60 <sup>†</sup>	5068	FS-FM-60-F	5812	FS-FM-60EF	8558	FS-FM-60KV	6766	FS-FM-60FV	6963	3	84 lbs.	18
80"	FS-FM-80 <sup>†</sup>	5780	FS-FM-80-F	6771	FS-FM-80EF	10433	FS-FM-80KV	8056	FS-FM-80FV	8306	4	120 lbs.	22
100"	FS-FM-100 <sup>†</sup>	6487	FS-FM-100-F	7726	FS-FM-100EF	12303	FS-FM-100KV	9394	FS-FM-100FV	9644	5	156 lbs.	30
120"	FS-FM-120 <sup>†</sup>	8171	FS-FM-120-F	9658	FS-FM-120EF	15150	FS-FM-120KV	11560	FS-FM-120FV	11960	6	198 lbs.	36

<sup>†</sup>Add K-472 For Faucet Hole Revision \$121

### 14 GA., 304 STAINLESS STEEL A.D.A. SINKS W/STAINLESS STEEL LEGS & FLANGED FEET

5" Bowl Depth • 8 1/2" High Backsplash • 8" O.C. Faucet Holes on Manual Operated or Single Holes on Electronic Faucet Operated  
 • Stainless Steel Flanged Feet • Wall Support Bracket • Rear Cross-Bracing • 3 1/2" Basket Drain(s)



L	NO FAUCETS INCLUDED		MANUAL FAUCETS INCLUDED		ELECTRONIC OPERATED FAUCETS		# of Faucets	Wt.	Cu. Ft.
	Model #	Price	Model #	Price	Model #	Price			
40"	FS-FM-40-ADA <sup>†</sup>	\$4507	FS-FM-40-ADA-F	\$5005	FS-FM-40EFADA	\$6622	2	72 lbs.	15
60"	FS-FM-60-ADA <sup>†</sup>	5068	FS-FM-60-ADA-F	5894	FS-FM-60EFADA	8318	3	84 lbs.	18
80"	FS-FM-80-ADA <sup>†</sup>	5780	FS-FM-80-ADA-F	6939	FS-FM-80EFADA	11074	4	120 lbs.	22
100"	FS-FM-100-ADA <sup>†</sup>	6487	FS-FM-100-ADA-F	7987	FS-FM-100EFADA	12029	5	156 lbs.	30
120"	FS-FM-120-ADA <sup>†</sup>	8171	FS-FM-120-ADA-F	10007	FS-FM-120EFADA	14856	6	198 lbs.	36

<sup>†</sup>Add K-472 For Faucet Hole Revision \$121



### 16 GA., 304 STAINLESS STEEL SINKS WITH STAINLESS STEEL LEGS & FLANGED FEET

8" Bowl Depth • 8 1/2" High Backsplash • 8" O.C. Faucet Holes on Manual Operated, Single Holes on Knee/Toe-Push or Electronic Operated  
 • Stainless Steel Flanged Feet • Wall Support Bracket • Side & Rear Cross-Bracing • 3 1/2" Basket Drain(s)



L	NO FAUCETS INCLUDED		MANUAL FAUCETS INCLUDED		ELECTRONIC OPERATED FAUCETS		KNEE OPERATED FAUCETS		TOE-PUSH OPERATED FAUCETS		# of Faucets	Wt.	Cu. Ft.
	Model #	Price	Model #	Price	Model #	Price	Model #	Price	Model #	Price			
40"	FC-FM-40 <sup>†</sup>	\$3953	FC-FM-40-F	\$4449	FC-FM-40EF	\$6279	FC-FM-40KV	\$5055	FC-FM-40FV	\$5215	2	66 lbs.	15
60"	FC-FM-60 <sup>†</sup>	4512	FC-FM-60-F	5255	FC-FM-60EF	8002	FC-FM-60KV	6076	FC-FM-60FV	6406	3	77 lbs.	18
80"	FC-FM-80 <sup>†</sup>	5300	FC-FM-80-F	6292	FC-FM-80EF	9953	FC-FM-80KV	7380	FC-FM-80FV	7827	4	110 lbs.	22
100"	FC-FM-100 <sup>†</sup>	6080	FC-FM-100-F	7319	FC-FM-100EF	11894	FC-FM-100KV	8572	FC-FM-100FV	9236	5	143 lbs.	30
120"	FC-FM-120 <sup>†</sup>	7315	FC-FM-120-F	8802	FC-FM-120EF	14294	FC-FM-120KV	10208	FC-FM-120FV	11104	6	182 lbs.	36

<sup>†</sup>Add K-472 For Faucet Hole Revision \$121

### 16 GA., 304 STAINLESS STEEL A.D.A. SINKS W/STAINLESS STEEL LEGS & FLANGED FEET

5" Bowl Depth • 8 1/2" High Backsplash • 8" O.C. Faucet Holes on Manual Operated or Single Holes on Electronic Faucet Operated  
 • Stainless Steel Flanged Feet • Wall Support Bracket • Rear Cross-Bracing • 3 1/2" Basket Drain(s)



L	NO FAUCETS INCLUDED		MANUAL FAUCETS INCLUDED		ELECTRONIC OPERATED FAUCETS		# of Faucets	Wt.	Cu. Ft.
	Model #	Price	Model #	Price	Model #	Price			
40"	FC-FM-40-ADA <sup>†</sup>	\$3954	FC-FM-40-ADA-F	\$4503	FC-FM-40EFADA	\$6120	2	66 lbs.	15
60"	FC-FM-60-ADA <sup>†</sup>	4512	FC-FM-60-ADA-F	5358	FC-FM-60EFADA	7783	3	77 lbs.	18
80"	FC-FM-80-ADA <sup>†</sup>	5300	FC-FM-80-ADA-F	6387	FC-FM-80EFADA	9620	4	110 lbs.	22
100"	FC-FM-100-ADA <sup>†</sup>	6080	FC-FM-100-ADA-F	7635	FC-FM-100EFADA	11676	5	143 lbs.	30
120"	FC-FM-120-ADA <sup>†</sup>	7315	FC-FM-120-ADA-F	9152	FC-FM-120EFADA	14001	6	182 lbs.	36

<sup>†</sup>Add K-472 For Faucet Hole Revision \$121



FC-FM-40-EFADA Shown

 = Ships Via UPS



# SERVICE SINKS

## NSF Service Sinks

### 14 GA., 304 STAINLESS STEEL SERVICE SINKS W/STAINLESS STEEL LEGS & FLANGED FEET



10" or 12" Bowl Depth • 8-1/2" High Backsplash • 8" O.C. Faucet Holes on Manual Operated, Single Holes on Knee/Toe-Push or Electronic Operated  
 • Stainless Steel Flanged Feet • Wall Support Bracket • Side & Rear Cross-Bracing 3 1/2" Basket Drain(s)



FS-FM-2219 Shown    FS-FM-2219-F Shown    FS-FM-2219EF Shown    FS-FM-2219KV Shown    FS-FM-2219FV Shown

NO FAUCET INCLUDED		MANUAL FAUCETS INCLUDED		ELECTRONIC OPERATED FAUCETS		KNEE OPERATED FAUCETS		TOE-PUSH OPERATED FAUCETS		Bowl Depth			Cu. Ft.
Model #	Price	Model #	Price	Model #	Price	Model #	Price	Model #	Price	L	W	Wt.	Ft.
FS-FM-2219 <sup>†</sup>	\$2619	FS-FM-2219-F	\$2906	FS-FM-2219EF	\$3781	FS-FM-2219KV*	\$3250	FS-FM-2219FV	\$3571	10"	23"	19 1/2"	62 lbs. 10
FS-FM-2721 <sup>†</sup>	2759	FS-FM-2721-F	3047	FS-FM-2721EF	3922	FS-FM-2721KV*	3390	FS-FM-2721FV	3712	12"	27"	21 1/2"	77 lbs. 13

<sup>†</sup>Add K-472 For Faucet Hole Revision **\$121**

\*FS-WM-2219KV & FS-WM-2721KV Has 8" Bowl Depth

### 14 GA., 304 STAINLESS STEEL A.D.A. SERVICE SINKS W/STAINLESS STEEL LEGS & FLANGED FEET



5" Bowl Depth • 8-1/2" High Backsplash • 8" O.C. Faucet Holes on Manual Operated, Single Hole on Electronic Operated  
 • Stainless Steel Flanged Feet • Wall Support Bracket • Rear Cross-Bracing • 3 1/2" Basket Drain(s)



FS-FM-1-ADA Shown

NO FAUCET INCLUDED		MANUAL FAUCET INCLUDED		ELECTRONIC OPERATED FAUCET		Bowl Depth			Cu. Ft.
Model #	Price	Model #	Price	Model #	Price	L	W	Wt.	Ft.
FS-FM-1-ADA <sup>†</sup>	\$3983	FS-FM-1-ADA-F	\$4338	FS-FM-1-EFADA	\$5145	6"	40"	19-1/2"	89 lbs. 15

<sup>†</sup>Add K-472 For Faucet Hole Revision **\$121**

### 16 GA., 304 STAINLESS STEEL SERVICE SINKS W/STAINLESS STEEL LEGS & FLANGED FEET



10" or 12" Bowl Depth • 8-1/2" High Backsplash • 8" O.C. Faucet Holes on Manual Operated, Single Holes on Knee/Toe-Push or Electronic Operated  
 • Stainless Steel Flanged Feet • Wall Support Bracket • Side & Rear Cross-Bracing • 3 1/2" Basket Drain(s)



FC-FM-2219 Shown    FC-FM-2219-F Shown    FC-FM-2219EF Shown    FC-FM-2219KV Shown    FC-FM-2219FV Shown



Toe-Push Valve

NO FAUCET INCLUDED		MANUAL FAUCET INCLUDED		ELECTRONIC OPERATED FAUCET		KNEE OPERATED FAUCET		TOE-PUSH OPERATED FAUCETS		Bowl Depth			Cu. Ft.
Model #	Price	Model #	Price	Model #	Price	Model #	Price	Model #	Price	L	W	Wt.	Ft.
FC-FM-2219 <sup>†</sup>	\$2371	FC-FM-2219-F	\$2659	FC-FM-2219EF	\$3534	FC-FM-2219KV*	\$3003	FC-FM-2219FV	\$2915	10"	23"	19 1/2"	57 lbs. 10
FC-FM-2721 <sup>†</sup>	2475	FC-FM-2721-F	2763	FC-FM-2721EF	3637	FC-FM-2721KV*	3106	FC-FM-2721FV	3018	12"	27"	21 1/2"	70 lbs. 13

<sup>†</sup>Add K-472 For Faucet Hole Revision **\$121**

\*FC-WM-2219KV & FC-WM-2721KV Has 8" Bowl Depth

### 16 GA., 304 STAINLESS STEEL A.D.A. SERVICE SINKS W/STAINLESS STEEL LEGS & FLANGED FEET



5" Bowl Depth • 8-1/2" High Backsplash • 8" O.C. Faucet Holes on Manual Operated, Single Hole on Electronic Operated  
 • Stainless Steel Flanged Feet • Wall Support Bracket • Rear Cross-Bracing • 3 1/2" Basket Drain(s)



FC-FM-1-EFADA Shown

NO FAUCET INCLUDED		MANUAL FAUCET INCLUDED		ELECTRONIC OPERATED FAUCET		Bowl Depth			Cu. Ft.
Model #	Price	Model #	Price	Model #	Price	L	W	Wt.	Ft.
FC-FM-1-ADA <sup>†</sup>	\$3794	FC-FM-1-ADA-F	\$4149	FC-FM-1-EFADA	\$4957	5"	40"	19 1/2"	75 lbs. 15

<sup>†</sup>Add K-472 For Faucet Hole Revision **\$121**

**WARNING:** Equipment that include faucets on this page may contain a chemical known to the State of California to cause cancer, birth defects or other reproductive harm.

# MULTI-STATIONS

## Square Corner Multi-Stations

 = Ships Via UPS

### 16 GA., 304 STAINLESS STEEL MULTI-STATIONS W/STAINLESS STEEL LEGS & FLANGED FEET

8" Bowl Depth • 8 1/2" High Backsplash • 8" O.C. Faucet Holes on Manual Operated, Single Holes on Knee/Toe-Push or Electronic Operated  
 • Stainless Steel Flanged Feet • Wall Support Bracket • Side & Rear Cross-Bracing • 3 1/2" Basket Drain(s)



Toe-Push Valve

19-FM-40 Shown

19-FM-40-F Shown

19-FM-40EF Shown

19-FM-40KV Shown

19-FM-40FV Shown

L	NO FAUCETS INCLUDED		MANUAL FAUCETS INCLUDED		ELECTRONIC OPERATED FAUCETS		KNEE OPERATED FAUCETS		TOE-PUSH OPERATED FAUCETS		# of Faucets	Wt.	Cu. Ft.
	Model #	Price	Model #	Price	Model #	Price	Model #	Price	Model #	Price			
23"	19-FM-23 <sup>†</sup>	\$2185	19-FM-23-F	\$2433	19-FM-23EF	\$3415	19-FM-23KV	\$2883	19-FM-23FV	\$2795	1	50 lbs.	10
40"	19-FM-40 <sup>†</sup>	3270	19-FM-40-F	3765	19-FM-40EF	5595	19-FM-40KV	4532	19-FM-40FV	4371	2	60 lbs.	15
60"	19-FM-60 <sup>†</sup>	3890	19-FM-60-F	4634	19-FM-60EF	7380	19-FM-60KV	5784	19-FM-60FV	5455	3	70 lbs.	18
80"	19-FM-80 <sup>†</sup>	4278	19-FM-80-F	5269	19-FM-80EF	9035	19-FM-80KV	6908	19-FM-80FV	6463	4	90 lbs.	22
100"	19-FM-100 <sup>†</sup>	5109	19-FM-100-F	6348	19-FM-100EF	10925	19-FM-100KV	8267	19-FM-100FV	7602	5	120 lbs.	30
120"	19-FM-120 <sup>†</sup>	6391	19-FM-120-F	7878	19-FM-120EF	13370	19-FM-120KV	10180	19-FM-120FV	9284	6	155 lbs.	36

<sup>†</sup>Add K-472 For Faucet Hole Revision \$121



### 16 GAUGE, 304 STAINLESS STEEL A.D.A. MULTI-STATIONS WITH TUBULAR SUPPORTS



5" Bowl Depth • 8 1/2" High Backsplash • 8" O.C. Faucet Holes on Manual Operated or Single Holes on Electronic Faucet Operated  
 • Stainless Steel Flanged Feet • Wall Support Bracket • Rear Cross-Bracing • 3 1/2" Basket Drain(s)

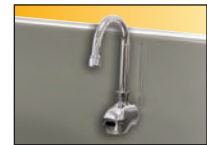

Hands-Free Electronic Faucet

19-FM-40-ADA Shown

19-FM-40-ADA\_F Shown

19-FM-40-EFADA Shown

L	NO FAUCETS INCLUDED		MANUAL FAUCETS INCLUDED		ELECTRONIC OPERATED FAUCETS		# of Faucets	Wt.	Cu. Ft.
	Model #	Price	Model #	Price	Model #	Price			
40"	19-FM-40-ADA <sup>†</sup>	\$3270	19-FM-40-ADA-F	\$3948	19-FM-40EFADA	\$5505	2	60 lbs.	15
60"	19-FM-60-ADA <sup>†</sup>	3890	19-FM-60-ADA-F	4955	19-FM-60EFADA	7230	3	70 lbs.	18
80"	19-FM-80-ADA <sup>†</sup>	4278	19-FM-80-ADA-F	5802	19-FM-80EFADA	8930	4	100 lbs.	22
100"	19-FM-100-ADA <sup>†</sup>	5109	19-FM-100-ADA-F	6884	19-FM-100EFADA	10820	5	130 lbs.	30
120"	19-FM-120-ADA <sup>†</sup>	6391	19-FM-120-ADA-F	8521	19-FM-120EFADA	13191	6	165 lbs.	36

<sup>†</sup>Add K-472 For Faucet Hole Revision \$121



# SERVICE SINKS

## Square Corner Service Sinks

### 16 GAUGE, 304 STAINLESS STEEL SERVICE SINKS W/STAINLESS STEEL LEGS & FLANGED FEET



12" Bowl Depth (Excludes Knee Valve Units) • 8 1/2" High Backsplash • 8" O.C. Faucet Holes on Manual Operated, Single Holes on Knee/Toe-Push or Electronic Operated  
 • Stainless Steel Flanged Feet • Wall Support Bracket • Side & Rear Cross-Bracing • 3 1/2" Basket Drain(s)



WSS-14-21-FM Shown



WSS-14-21-FM-F Shown



WSS-14-21EF-FM Shown



WSS-14-21KV-FM Shown



WSS-14-21FV-FM Shown



Toe-Push Valve

NO FAUCET INCLUDED		MANUAL FAUCET INCLUDED		ELECTRONIC OPERATED FAUCETS		KNEE OPERATED FAUCETS		TOE-PUSH OPERATED FAUCETS		L	W	Wt.	Cu. Ft.
Model #	Price	Model #	Price	Model #	Price	Model #	Price	Model #	Price				
WSS-14-21-FM <sup>†</sup>	\$2277	WSS-14-21-FM-F	\$2525	WSS-14-21EF-FM	\$3440	WSS-14-21KV-FM*	\$2909	WSS-14-21FV-FM	\$2820	18"	17-1/2"	45 lbs.	8
WSS-16-25-FM <sup>†</sup>	2472	WSS-16-25-FM-F	2720	WSS-16-25EF-FM	3635	WSS-16-25KV-FM*	3104	WSS-16-25FV-FM	3016	22"	22"	52 lbs.	10

<sup>†</sup>Add **K-472** For Faucet Hole Revision **\$121**

\*Knee Valve Unit Has 8" Bowl Depth



### 16 GAUGE, 304 STAINLESS STEEL A.D.A. SERVICE SINKS WITH TUBULAR SUPPORTS



5" Bowl Depth • 8 1/2" High Backsplash • 8" O.C. Faucet Holes on Manual Operated, Single Holes on Electronic Operated  
 • Stainless Steel Flanged Feet • Wall Support Bracket • Rear Cross-Bracing • 3 1/2" Basket Drain(s)



19-FM-1-ADA Shown



19-FM-1-ADA\_F Shown



19-FM-1-EFADA Shown

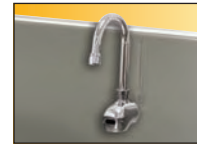

Hands-Free Electronic Faucet

NO FAUCET INCLUDED		MANUAL FAUCET INCLUDED		ELECTRONIC OPERATED FAUCET		L	W	Wt.	Cu. Ft.
Model #	Price	Model #	Price	Model #	Price				
19-FM-1-ADA <sup>†</sup>	\$3177	19-FM-1-ADA-F <sup>†</sup>	\$3465	19-FM-1-EFADA	\$4285	40"	19 1/2"	60 lbs.	15

<sup>†</sup>Add **K-472** For Faucet Hole Revision **\$121**

### MULTI-STATION HAND SINK ACCESSORIES & MODIFICATIONS



K-159



K-161-LU



K-101



TA-19



K-6

Model	Description	Price	Model	Description	Price
K-6	3 1/2" Drain (1 1/2" I.P.S.)	\$44 ea.	K-316-LU	Wrist Handles	114 pair
K-13	Stainless Steel Soap Dispenser	392 ea.	K-411	Strainer Plate for 3-1/2" Drain	22 ea.
K-101	8" Swing Spout Splash Mt. Faucet	215 ea.	K-1118	Extra H.D. 8" Splash Mounted Faucet	366 ea.
K-121	Single Hole, Splash Mounted 3-1/2" Gooseneck Spout	134 ea.	K-508	Special Sizing Charge (Larger Size Cut Down To Smaller Size)	N/C
K-159	Splash Mounted 3-1/2" Gooseneck Faucet (8" O.C.)	248 ea.	K-508	Special Sizing Charge (Larger Size Cut Down To Smaller Size)	N/C
K-161-LU	Splash Mounted 3-1/2" Gooseneck Faucet (8" O.C.) with wrist handles	355 ea.	TA-19	Adjustable Stainless Steel Flanged Bullet Foot	56 ea.

**WARNING:** Equipment that includes a faucet may expose you to chemicals, including lead, that are known to the State of California to cause cancer or birth defects or other reproductive harm. For more info., visit [www.p65warnings.ca.gov](http://www.p65warnings.ca.gov).

# REGALINE

## Deep Drawn Sinks

ALL MODELS INCLUDE  
STAINLESS STEEL LEGS  
& BULLET FEET



Deep Drawn Bowls Are Seamless And  
Drawn Out of a Single Sheet of Steel

### Features and Benefits

- 3" Large Radius Corners
- Easy to Clean
- Satin Finish
- No Welded Seams



### SPEC-LINE "94" Series

- 14 ga. 304 Stainless Steel
- Stainless Steel Adjustable Cross Bracing on Front & Rear; Welded On Sides
- 16 ga. 304 Stainless Steel Legs & Bullet Feet
- 11" Backsplash
- 14" Deep Sink Bowls

THE ONLY  
14 GAUGE  
Deep Drawn  
SINK!

### STANDARD "93" Series

- 16 ga. 304 Stainless Steel
- Stainless Steel Welded Side Cross Bracing
- Stainless Steel Legs and Bullet Feet
- 8" Backsplash
- 12" Deep Sink Bowls

### SUPERSAVER "9" Series

- 18 ga. 304 Stainless Steel
- Stainless Steel Welded Side Cross Bracing
- Stainless Steel Legs and Bullet Feet
- 8" Backsplash
- 12" Deep Sink Bowls

## ONE, TWO, THREE AND FOUR COMPARTMENTS with No Drainboards



94 Series Shown

### Spec-Line 94 Series

### Standard 93 Series

### Super Saver 9 Series

14 Ga. 304 S/S 14" Water Level			16 Ga. 304 S/S 12" Water Level			18 Ga. 304 S/S 12" Water Level		
-----------------------------------	--	--	-----------------------------------	--	--	-----------------------------------	--	--

Bowl Size	O.A. Length	# of Comp.	Model #	Price	Approx. Wt. (lbs.)	Model #	Price	Approx. Wt. (lbs.)	Model #	Price	Approx. Wt. (lbs.)	Cu. Ft.
16" x 20"	25"	One	94-1-24	\$3686	77	93-1-24	\$2395	62	9-1-24	\$2197	54	20
	44"	Two	94-2-36	4782	109	93-2-36	3283	76	9-2-36	3009	66	20
	62"	Three	94-3-54	5909	142	93-3-54	4156	107	9-3-54	3810	95	28
	*81"	Four	94-4-72	7555	225	93-4-72	5374	176	9-4-72	4932	155	44
20" x 20"	29"	One	94-21-20	4026	92	93-21-20	2610	80	9-21-20	2571	61	20
	52"	Two	94-22-40	5250	116	93-22-40	3612	92	9-22-40	3312	79	23
	74"	Three	94-23-60	6759	232	93-23-60	4789	188	9-23-60	4389	169	44
	*97"	Four	94-24-80	8495	285	93-24-80	6117	210	9-24-80	5626	192	56
18" x 24"	27"	One	94-61-18	4187	95	93-61-18	2807	84	9-61-18	2592	78	24
	48"	Two	94-62-36	5370	165	93-62-36	3781	144	9-62-36	3492	132	26
	68"	Three	94-63-54	6839	249	93-63-54	4921	203	9-63-54	4535	188	36
	89"	Four	94-64-72	8524	312	93-64-72	6212	264	9-64-72	5738	255	56
24" x 24"	33"	One	94-41-24	4313	97	93-41-24	3025	85	9-41-24	2775	80	23
	60"	Two	94-42-48	6241	174	93-42-48	4558	145	9-42-48	4180	133	31
	*86"	Three	94-43-72	7862	252	93-43-72	5968	213	9-43-72	5474	200	56
	*113"	Four	94-44-96	9772	347	93-44-96	7659	302	9-44-96	7018	281	74
20" x 28"	29"	One	94-81-20	4754	134	93-81-20	3148	94	9-81-20	2877	82	27
	52"	Two	94-82-40	6256	176	93-82-40	4624	150	9-82-40	4237	138	45
	74"	Three	94-83-60	8099	255	93-83-60	6172	225	9-83-60	5657	216	65
	*97"	Four	94-84-80	10335	345	93-84-80	7981	310	9-84-80	7307	287	78



# REGALINE

## Deep Drawn Sinks

### ONE COMPARTMENT WITH TWO DRAINBOARDS

94 Series Shown



#### Spec-Line 94 Series

#### Standard 93 Series

#### Super Saver 9 Series

14 Ga. 304 S/S 14" Water Level	16 Ga. 304 S/S 12" Water Level	18 Ga. 304 S/S 12" Water Level
-----------------------------------	-----------------------------------	-----------------------------------

Bowl Size	O.A. Length	DRBD. Size	Model #	Price	Approx. Wt. (lbs.)	Model #	Price	Approx. Wt. (lbs.)	Model #	Price	Approx. Wt. (lbs.)	Cu. Ft.
<b>16" x 20"</b>	54"	18"	94-1-24-18RL	\$3953	97	93-1-24-18RL	\$3439	82	9-1-24-18RL	\$3261	71	29
	66"	24"	94-1-24-24RL	4110	118	93-1-24-24RL	3549	95	9-1-24-24RL	3281	95	33
	90"	36"	94-1-24-36RL	4519	164	93-1-24-36RL	3807	134	9-1-24-36RL	3484	134	48
<b>20" x 20"</b>	58"	18"	94-21-20-18RL	4342	95	93-21-20-18RL	3767	78	9-21-20-18RL	3425	78	26
	70"	24"	94-21-20-24RL	4480	117	93-21-20-24RL	3800	92	9-21-20-24RL	3500	92	34
	94"	36"	94-21-20-36RL	5082	168	93-21-20-36RL	4035	147	9-21-20-36RL	3890	147	50
<b>18" x 24"</b>	56"	18"	94-61-18-18RL	4490	160	93-61-18-18RL	3931	138	9-61-18-18RL	3599	138	29
	68"	24"	94-61-18-24RL	4625	179	93-61-18-24RL	3965	150	9-61-18-24RL	3673	150	43
	92"	36"	94-61-18-36RL	5204	210	93-61-18-36RL	4194	180	9-61-18-36RL	4056	180	67
<b>24" x 24"</b>	74"	24"	94-41-24-24RL	5193	213	93-41-24-24RL	4615	185	9-41-24-24RL	4285	185	48
	98"	36"	94-41-24-36RL	6081	252	93-41-24-36RL	4797	210	9-41-24-36RL	4482	210	64
<b>20" x 28"</b>	58"	18"	94-81-20-18RL	5142	173	93-81-20-18RL	4657	150	9-81-20-18RL	4335	150	46
	70"	24"	94-81-20-24RL	5282	186	93-81-20-24RL	4797	165	9-81-20-24RL	4477	165	55
	94"	36"	94-81-20-36RL	6647	225	93-81-20-36RL	4943	195	9-81-20-36RL	4591	195	73

Weights and Cubes are approximate

### ONE COMPARTMENT WITH ONE DRAINBOARD

94 Series Shown



#### Spec-Line 94 Series

#### Standard 93 Series

#### Super Saver 9 Series

14 Ga. 304 S/S 14" Water Level	16 Ga. 304 S/S 12" Water Level	18 Ga. 304 S/S 12" Water Level
-----------------------------------	-----------------------------------	-----------------------------------

Bowl Size	O.A. Length	DRBD. Size	Model #	Price	Approx. Wt. (lbs.)	Model #	Price	Approx. Wt. (lbs.)	Model #	Price	Approx. Wt. (lbs.)	Cu. Ft.
<b>16" x 20"</b>	40"	18"	94-1-24-18RorL	\$3805	93	93-1-24-18RorL	\$3284	75	9-1-24-18RorL	\$3081	65	20
	46"	24"	94-1-24-24RorL	3870	98	93-1-24-24RorL	3324	80	9-1-24-24RorL	3111	73	24
	58"	36"	94-1-24-36RorL	4218	114	93-1-24-36RorL	3674	90	9-1-24-36RorL	3389	78	26
<b>20" x 20"</b>	44"	18"	94-21-20-18RorL	4178	98	93-21-20-18RorL	3639	80	9-21-20-18RorL	3304	71	20
	50"	24"	94-21-20-24RorL	4243	104	93-21-20-24RorL	3668	86	9-21-20-24RorL	3339	77	23
	62"	36"	94-21-20-36RorL	4753	127	93-21-20-36RorL	3773	107	9-21-20-36RorL	3417	91	31
<b>18" x 24"</b>	42"	18"	94-61-18-18RorL	4325	100	93-61-18-18RorL	3806	84	9-61-18-18RorL	3484	75	24
	48"	24"	94-61-18-24RorL	4394	106	93-61-18-24RorL	3834	92	9-61-18-24RorL	3513	84	27
	60"	36"	94-61-18-36RorL	4890	130	93-61-18-36RorL	3934	109	9-61-18-36RorL	3588	95	38
<b>24" x 24"</b>	54"	24"	94-41-24-24RorL	4958	126	93-41-24-24RorL	4411	105	9-41-24-24RorL	4026	92	28
	66"	36"	94-41-24-36RorL	5725	149	93-41-24-36RorL	4510	126	9-41-24-36RorL	4131	110	42
<b>20" x 28"</b>	44"	18"	94-81-20-18RorL	4852	139	93-81-20-18RorL	4446	116	9-81-20-18RorL	4079	107	36
	50"	24"	94-81-20-24RorL	4935	146	93-81-20-24RorL	4532	122	9-81-20-24RorL	4157	113	46
	62"	36"	94-81-20-36RorL	6230	170	93-81-20-36RorL	4617	142	9-81-20-36RorL	4259	133	54

Weights and Cubes are approximate

See pages 33 and 34 for faucets, accessories, and modifications.

# REGALINE

## Deep Drawn Sinks



### TWO COMPARTMENTS WITH TWO DRAINBOARDS

#### Spec-Line 94 Series

#### Standard 93 Series

#### Super Saver 9 Series

14 Ga. 304 S/S  
14" Water Level

16 Ga. 304 S/S  
12" Water Level

18 Ga. 304 S/S  
12" Water Level

Bowl Size	O.A. Length	DRBD. Size	Model #	Price	Approx. Wt. (lbs.)	Model #	Price	Approx. Wt. (lbs.)	Model #	Price	Approx. Wt. (lbs.)	Cu. Ft.
16" x 20"	72"	18"	94-2-36-18RL	\$5320	141	93-2-36-18RL	\$4514	118	9-2-36-18RL	\$4117	100	40
	85"	24"	94-2-36-24RL	5445	156	93-2-36-24RL	4597	130	9-2-36-24RL	4184	110	46
	109"	36"	94-2-36-36RL	6021	212	93-2-36-36RL	5195	169	9-2-36-36RL	4677	144	58
20" x 20"	81"	18"	94-22-40-18RL	5999	176	93-22-40-18RL	5104	147	9-22-40-18RL	4561	125	44
	93"	24"	94-22-40-24RL	6099	220	93-22-40-24RL	5162	184	9-22-40-24RL	4599	162	50
	117"	36"	94-22-40-36RL	6670	273	93-22-40-36RL	5477	237	9-22-40-36RL	4854	215	72
18" x 24"	77"	18"	94-62-36-18RL	6099	247	93-62-36-18RL	5231	206	9-62-36-18RL	4707	181	50
	89"	24"	94-62-36-24RL	6199	277	93-62-36-24RL	5285	241	9-62-36-24RL	4742	226	58
	113"	36"	94-62-36-36RL	6748	341	93-62-36-36RL	5585	297	9-62-36-36RL	4985	271	96
24" x 24"	101"	24"	94-42-48-24RL	7384	339	93-42-48-24RL	6534	295	9-42-48-24RL	5920	259	65
	125"	36"	94-42-48-36RL	7929	391	93-42-48-36RL	6766	339	9-42-48-36RL	6635	314	96
20" x 28"	81"	18"	94-82-40-18RL	7018	251	93-82-40-18RL	6819	219	9-82-40-18RL	6471	194	64
	93"	24"	94-82-40-24RL	7332	294	93-82-40-24RL	6966	253	9-82-40-24RL	6615	228	73
	117"	36"	94-82-40-36RL	7828	333	93-82-40-36RL	7106	287	9-82-40-36RL	6736	261	96

Weights and Cubes are approximate



### TWO COMPARTMENTS WITH ONE DRAINBOARD

#### Spec-Line 94 Series

#### Standard 93 Series

#### Super Saver 9 Series

14 Ga. 304 S/S  
14" Water Level

16 Ga. 304 S/S  
12" Water Level

18 Ga. 304 S/S  
12" Water Level

Bowl Size	O.A. Length	DRBD. Size	Model #	Price	Approx. Wt. (lbs.)	Model #	Price	Approx. Wt. (lbs.)	Model #	Price	Approx. Wt. (lbs.)	Cu. Ft.
16" x 20"	58"	18"	94-2-36-18RorL	\$5142	108	93-2-36-18RorL	\$4347	88	9-2-36-18RorL	\$3987	72	26
	64"	24"	94-2-36-24RorL	5231	115	93-2-36-24RorL	4413	96	9-2-36-24RorL	4030	80	34
	76"	36"	94-2-36-36RorL	5500	158	93-2-36-36RorL	4492	132	9-2-36-36RorL	4090	115	42
20" x 20"	66"	18"	94-22-40-18RorL	5815	118	93-22-40-18RorL	4950	96	9-22-40-18RorL	4438	83	30
	72"	24"	94-22-40-24RorL	5884	136	93-22-40-24RorL	4975	114	9-22-40-24RorL	4457	95	39
	84"	36"	94-22-40-36RorL	6203	163	93-22-40-36RorL	5057	140	9-22-40-36RorL	4518	123	46
18" x 24"	62"	18"	94-62-36-18RorL	5920	147	93-62-36-18RorL	5076	128	9-62-36-18RorL	4589	115	40
	68"	24"	94-62-36-24RorL	5988	160	93-62-36-24RorL	5104	139	9-62-36-24RorL	4605	126	44
	80"	36"	94-62-36-36RorL	6298	200	93-62-36-36RorL	5182	174	9-62-36-36RorL	4662	158	53
24" x 24"	80"	24"	94-42-48-24RorL	7080	229	93-42-48-24RorL	6266	194	9-42-48-24RorL	5719	172	53
	92"	36"	94-42-48-36RorL	7510	261	93-42-48-36RorL	6744	235	9-42-48-36RorL	6429	194	60
20" x 28"	66"	18"	94-82-40-18RorL	6968	213	93-82-40-18RorL	6673	183	9-82-40-18RorL	6269	167	60
	72"	24"	94-82-40-24RorL	7050	227	93-82-40-24RorL	6755	195	9-82-40-24RorL	6349	176	64
	84"	36"	94-82-40-36RorL	7438	266	93-82-40-36RorL	6975	227	9-82-40-36RorL	6402	207	76

Weights and Cubes are approximate

See pages 33 and 34 for faucets, accessories, and modifications.



# REGALINE

## Deep Drawn Sinks



### THREE COMPARTMENTS WITH TWO DRAINBOARDS

Spec-Line 94 Series

Standard 93 Series

Super Saver 9 Series

14 Ga. 304 S/S  
14" Water Level

16 Ga. 304 S/S  
12" Water Level

18 Ga. 304 S/S  
12" Water Level

Bowl Size	O.A. Length	DRBD. Size	Model #	Price	Approx. Wt. (lbs.)	Model #	Price	Approx. Wt. (lbs.)	Model #	Price	Approx. Wt. (lbs.)	Cu. Ft.
<b>16" x 20"</b>	91"	18"	94-3-54-18RL	\$6307	230	93-3-54-18RL	\$5403	189	9-3-54-18RL	\$4173	182	49
	103"	24"	94-3-54-24RL	6440	248	93-3-54-24RL	5485	197	9-3-54-24RL	4243	190	55
	127"	36"	94-3-54-36RL	7061	275	93-3-54-36RL	5821	239	9-3-54-36RL	5485	208	96
<b>20" x 20"</b>	103"	18"	94-23-60-18RL	7430	248	93-23-60-18RL	6407	203	9-23-60-18RL	5747	198	59
	115"	24"	94-23-60-24RL	7648	276	93-23-60-24RL	6573	220	9-23-60-24RL	5887	195	65
	139"	36"	94-23-60-36RL	8249	408	93-23-60-36RL	6811	387	9-23-60-36RL	6076	364	89
<b>18" x 24"</b>	97"	18"	94-63-54-18RL	7488	323	93-63-54-18RL	6493	289	9-63-54-18RL	5855	226	62
	109"	24"	94-63-54-24RL	7702	334	93-63-54-24RL	6650	304	9-63-54-24RL	5994	233	85
	133"	36"	94-63-54-36RL	8280	418	93-63-54-36RL	6887	367	9-63-54-36RL	6170	325	96
<b>24" x 24"</b>	*127"	24"	94-43-72-24RL	9126	390	93-43-72-24RL	8224	331	9-43-72-24RL	7458	318	98
	*151"	36"	94-43-72-36RL	9790	448	93-43-72-36RL	8405	393	9-43-72-36RL	7949	345	110
<b>20" x 28"</b>	103"	18"	94-83-60-18RL	9234	358	93-83-60-18RL	8260	315	9-83-60-18RL	7869	277	83
	115"	24"	94-83-60-24RL	9368	394	93-83-60-24RL	8401	346	9-83-60-24RL	8003	305	95
	139"	36"	94-83-60-36RL	10070	451	93-83-60-36RL	8602	398	9-83-60-36RL	8141	350	109

\* Requires Two Faucets

Weights and Cubes are approximate



### THREE COMPARTMENTS WITH ONE DRAINBOARD

Spec-Line 94 Series

Standard 93 Series

Super Saver 9 Series

14 Ga. 304 S/S  
14" Water Level

16 Ga. 304 S/S  
12" Water Level

18 Ga. 304 S/S  
12" Water Level

Bowl Size	O.A. Length	DRBD. Size	Model #	Price	Approx. Wt. (lbs.)	Model #	Price	Approx. Wt. (lbs.)	Model #	Price	Approx. Wt. (lbs.)	Cu. Ft.
<b>16" x 20"</b>	77"	18"	94-3-54-18RorL	\$6157	214	93-3-54-18RorL	\$5258	173	9-3-54-18RorL	\$4033	167	42
	83"	24"	94-3-54-24RorL	6222	222	93-3-54-24RorL	5298	188	9-3-54-24RorL	4071	177	45
	95"	36"	94-3-54-36RorL	6575	243	93-3-54-36RorL	5652	220	9-3-54-36RorL	5098	190	51
<b>20" x 20"</b>	89"	18"	94-23-60-18RorL	7263	234	93-23-60-18RorL	6236	207	9-23-60-18RorL	5608	184	52
	95"	24"	94-23-60-24RorL	7311	245	93-23-60-24RorL	6263	205	9-23-60-24RorL	5626	193	55
	107"	36"	94-23-60-36RorL	7725	252	93-23-60-36RorL	6468	216	9-23-60-36RorL	5692	208	60
<b>18" x 24"</b>	83"	18"	94-63-54-18RorL	7328	296	93-63-54-18RorL	6324	271	9-63-54-18RorL	5719	255	54
	89"	24"	94-63-54-24RorL	7376	308	93-63-54-24RorL	6349	281	9-63-54-24RorL	5738	269	58
	101"	36"	94-63-54-36RorL	7774	318	93-63-54-36RorL	6553	300	9-63-54-36RorL	5798	287	65
<b>24" x 24"</b>	*107"	24"	94-43-72-24RorL	8894	342	93-43-72-24RorL	7984	312	9-43-72-24RorL	7295	298	68
	*119"	36"	94-43-72-36RorL	9612	365	93-43-72-36RorL	8051	339	9-43-72-36RorL	7742	320	96
<b>20" x 28"</b>	89"	18"	94-83-60-18RorL	8973	281	93-83-60-18RorL	8055	232	9-83-60-18RorL	7700	225	79
	95"	24"	94-83-60-24RorL	9052	296	93-83-60-24RorL	8135	273	9-83-60-24RorL	7776	268	86
	107"	36"	94-83-60-36RorL	9367	308	93-83-60-36RorL	8211	287	9-83-60-36RorL	7824	277	89

\* Requires Two Faucets

Weights and Cubes are approximate

See pages 33 and 34 for faucets, accessories, and modifications.

# REGALINE

## Deep Drawn Sinks



### FOUR COMPARTMENTS WITH TWO DRAINBOARDS

#### Spec-Line 94 Series

#### Standard 93 Series

#### Super Saver 9 Series

14 Ga. 304 S/S  
14" Water Level

16 Ga. 304 S/S  
12" Water Level

18 Ga. 304 S/S  
12" Water Level

Bowl Size	O.A. Length	DRBD. Size	Model #	Price	Approx. Wt. (lbs.)	Model #	Price	Approx. Wt. (lbs.)	Model #	Price	Approx. Wt. (lbs.)	Cu. Ft.
16" x 20"	110"	18"	94-4-72-18RL	\$7897	210	93-4-72-18RL	\$6806	183	9-4-72-18RL	\$6313	175	58
	122"	24"	94-4-72-24RL	8044	275	93-4-72-24RL	6909	252	9-4-72-24RL	6398	241	64
	146"	36"	94-4-72-36RL	8632	313	93-4-72-36RL	7119	287	9-4-72-36RL	6775	274	86
20" x 20"	126"	18"	94-24-80-18RL	9213	293	93-24-80-18RL	7929	268	9-24-80-18RL	7119	259	87
	138"	24"	94-24-80-24RL	9306	312	93-24-80-24RL	8030	286	9-24-80-24RL	7182	275	95
	162"	36"	94-24-80-36RL	9974	351	93-24-80-36RL	8251	322	9-24-80-36RL	7555	308	111
18" x 24"	118"	18"	94-64-72-18RL	9217	358	93-64-72-18RL	7972	346	9-64-72-18RL	7185	336	82
	130"	24"	94-64-72-24RL	9307	372	93-64-72-24RL	8069	355	9-64-72-24RL	7250	344	90
	154"	36"	94-64-72-36RL	9954	409	93-64-72-36RL	8283	392	9-64-72-36RL	7611	378	106
24" x 24"	154"	24"	94-44-96-24RL	10995	395	93-44-96-24RL	10356	361	9-44-96-24RL	9171	348	106
	178"	36"	94-44-96-36RL	11787	431	93-44-96-36RL	10593	398	9-44-96-36RL	9971	382	122
20" x 28"	126"	18"	94-84-80-18RL	11177	382	93-84-80-18RL	10580	361	9-84-80-18RL	9988	350	97
	138"	24"	94-84-80-24RL	11319	402	93-84-80-24RL	10722	374	9-84-80-24RL	10129	361	106
	162"	36"	94-84-80-36RL	12160	442	93-84-80-36RL	10931	411	9-84-80-36RL	10248	395	124

ALL UNITS REQUIRE TWO FAUCETS

Weights and Cubes are approximate



### FOUR COMPARTMENTS WITH ONE DRAINBOARD

#### Spec-Line 94 Series

#### Standard 93 Series

#### Super Saver 9 Series

14 Ga. 304 S/S  
14" Water Level

16 Ga. 304 S/S  
12" Water Level

18 Ga. 304 S/S  
12" Water Level

Bowl Size	O.A. Length	DRBD. Size	Model #	Price	Approx. Wt. (lbs.)	Model #	Price	Approx. Wt. (lbs.)	Model #	Price	Approx. Wt. (lbs.)	Cu. Ft.
16" x 20"	95"	18"	94-4-72-18RorL	\$7614	202	93-4-72-18RorL	\$6536	165	9-4-72-18RorL	\$6077	158	52
	101"	24"	94-4-72-24RorL	7683	216	93-4-72-24RorL	6580	186	9-4-72-24RorL	6105	175	54
	113"	36"	94-4-72-36RorL	8227	260	93-4-72-36RorL	6786	238	9-4-72-36RorL	6491	227	60
20" x 20"	111"	18"	94-24-80-18RorL	8991	299	93-24-80-18RorL	7770	241	9-24-80-18RorL	6463	229	61
	117"	24"	94-24-80-24RorL	9041	320	93-24-80-24RorL	7797	250	9-24-80-24RorL	7018	239	82
	129"	36"	94-24-80-36RorL	9576	341	93-24-80-36RorL	7902	267	9-24-80-36RorL	7105	250	90
18" x 24"	103"	18"	94-64-72-18RorL	9003	339	93-64-72-18RorL	7819	329	9-64-72-18RorL	6669	318	72
	109"	24"	94-64-72-24RorL	9052	351	93-64-72-24RorL	7847	338	9-64-72-24RorL	7089	329	76
	121"	36"	94-64-72-36RorL	9571	369	93-64-72-36RorL	7951	353	9-64-72-36RorL	7168	341	84
24" x 24"	133"	24"	94-44-96-24RorL	10694	354	93-44-96-24RorL	10131	336	9-44-96-24RorL	8974	327	92
	145"	36"	94-44-96-36RorL	11058	376	93-44-96-36RorL	10257	355	9-44-96-36RorL	9669	344	100
20" x 28"	111"	18"	94-84-80-18RorL	10917	348	93-84-80-18RorL	10372	329	9-84-80-18RorL	9790	317	87
	117"	24"	94-84-80-24RorL	10997	364	93-84-80-24RorL	10451	337	9-84-80-24RorL	9873	329	91
	129"	36"	94-84-80-36RorL	11699	382	93-84-80-36RorL	10534	355	9-84-80-36RorL	9915	347	100

ALL UNITS REQUIRE TWO FAUCETS

Weights and Cubes are approximate

See pages 33 and 34 for faucets, accessories, and modifications.



# SPECIALTY SINKS

## Specialty Sinks

### Corner Sinks

16 Gauge, 304 Stainless Steel

- Welded Cross-Bracing
- Stainless Steel Legs
- Stainless Steel Adjustable Bullet Feet



94-K3-11D Shown



MINI CORNER

OPTIONAL:

5/8" Thick Poly-Vance Cutting Boards Available  
(See Grid For Proper Model)

### Six Deep Drawn Combinations To Choose From!

Model #	Bowl Sizes	Wall Dim.	Drbd. Dim.	Price	Approx. Wt.	Approx. Cubes	Optional Poly-Vance Cutting Boards
94-K6-18D	1) 20" x 20" x 12" 2) 16" x 20" x 12"	61" x 61"	18"	\$7246	231 lbs.	71	K-2E \$281
94-K2-24D	3) 20" x 20" x 12"	71" x 71"	24"	7437	265 lbs.	99	K-2E 281
94-K4-24D	3) 24" x 24" x 12"	79" x 79"	24"	7931	338 lbs.	114	K-2F 281
94-K8-30D	1) 20" x 20" x 12" 2) 20" x 28" x 12"	86" x 86"	30"	8443	350 lbs.	131	K-2E 281
94-K3-11D	1) 14" x 14" x 12" 2) 14" x 16" x 12"	54" x 54"	17"	4965	215 lbs.	60	K-2H 281
94-K5-11D	1) 14" x 14" x 10" 2) 10" x 14" x 10"	42" x 42"	11"	5379	180 lbs.	37	K-2H 281

## FABRICATED SPECIALTY SINKS

### Convenience Store Sinks

Our Solution....to Your Limited Space Problem  
In Six Feet or less... you can WASH, RINSE & SANITIZE

- 18 Gauge Stainless Steel
- Stainless Steel Legs
- Welded Cross Bracing
- Stainless Steel Adjustable Bullet Feet

All Sinks Feature TWO Drainboards



Model #	Bowl Size	# of Comp.	Drbd. Size	O.A. Length	Price	Approx. Wt.	Approx. Cu.
K7-CS-21	10" x 14" x 10"	3	12"	58"	\$2653	85 lbs.	27
K7-CS-22	10" x 14" x 10"	3	18"	70"	2727	120 lbs.	39
K7-CS-29	14" x 16" x 12"	3	12"	70"	2906	138 lbs.	39
K7-CS-32	12" x 20" x 12"	3	12"	64"	3372	130 lbs.	35



### Super Size Sinks 16 Gauge, 304 Stainless Steel

Model #	Bowl Size	# of Comp.	Drbd. Size	Overall Size L x W	Price	Approx. Wt.	Approx. Cu.
K7-3-1432-18RL*	14" x 32" x 12"	3	18"	78" x 36"	\$7064	290 lbs.	50
K7-3-2030-24RL	20" x 30" x 14"	3	24"	108" x 36"	10114	345 lbs.	78
K7-3-2430-24RL	24" x 30" x 14"	3	24"	120" x 36"	10515	380 lbs.	86
K7-3-3024-24RL	30" x 24" x 14"	3	24"	138" x 30"	10884	395 lbs.	84
K7-3-3030-24RL	30" x 30" x 14"	3	24"	138" x 36"	11400	420 lbs.	98

\*12" Deep Bowls For 14 Gauge Units Add -14 At End Of Model Number & Add \$588 List.

- Fabricated Design
- 16 ga. 304 Series
- 14" Deep Bowls
- Tile Edge Splash
- Full Skirt Design
- Stainless Steel Legs
- Stainless Steel Adjustable Bullet Feet
- Space Saving - Reduced Overall Lengths

### Meat & Platter Sink

16 Gauge, 304 Stainless Steel

- Two 18" Drainboards
- 91" x 35 1/2"

Bowl Sizes:

- 1 - 24" x 30" Bowl
- 2 - 15" x 32" Bowls

• 351 lbs. 59 Cu. Ft.



18-K5-56 \$10679

### Heavy Duty Extra Long Faucet

Required Faucet For Meat & Platter Sink

- Splash Mount
- 18" Swing Spout
- 8" O.C.
- T&S Equivalent: 5f-8WLX18



K-211 \$610

Units Can Be Customized With Modifications & Accessories!  
See Pages 33 & 34. Other Sizes Available. Call For Pricing.

# FABRICATED

## Fabricated Sinks



Fabricated Bowls are Welded Together at the Seams & Polished

### Features and Benefits

- 3/4" Radius Corners
- Economical Savings
- Satin Finish

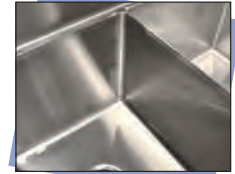

## SPEC-LINE 14 GAUGE FABRICATED SINKS

- 14 Ga. 304 Stainless Steel
- 14" Deep Bowls
- Tile Edge Splash
- Continuous Apron Design
- All Welded Super-Sturdy Cross-Bracing
- Stainless Steel Legs & Adjustable Stainless Steel Bullet Feet

### FS Series: 1 Compartment Sinks

Bowl Size	Model #	O.A. Length	O.A. Width	Price	Wt.	Cu.
16" x 20"	FS-1-1620	21"	26"	\$2265	60	12
	FS-1-1620-18RorL	36.5"	26"	2434	80	20
	FS-1-1620-18RL	52"	26"	2645	100	27
18" x 18"	FS-1-1818	23"	24"	2310	60	11
	FS-1-1818-18RorL	38.5"	24"	2598	75	17
18" x 24"	FS-1-1824	23"	30"	2511	78	16
	FS-1-1824-18RorL	38.5"	30"	2874	92	25
	FS-1-1824-24RorL	44.5"	30"	3016	105	28
	FS-1-1824-18RL	54"	30"	3087	175	34
	FS-1-1824-24RL	66"	30"	3222	198	40
24" x 24"	FS-1-2424	29"	30"	2888	90	19
	FS-1-2424-18RorL	44.5"	30"	3247	110	28
	FS-1-2424-24RorL	50.5"	30"	3284	119	34
	FS-1-2424-18RL	60"	30"	3351	185	37
	FS-1-2424-24RL	72"	30"	4043	209	44
30" x 24"	FS-1-3024	35"	30"	3320	115	23
	FS-1-3024-24RorL	56.5"	30"	3894	132	35
	FS-1-3024-24RL	78"	30"	4186	150	47
36" x 24"	FS-1-3624	41"	30"	3753	125	26
	FS-1-3624-24RorL	62.5"	30"	4330	143	39
	FS-1-3624-24RL	84"	30"	5630	165	51

### FS Series: 2 Compartment Sinks

Bowl Size	Model #	O.A. Length	O.A. Width	Price	Wt.	Cu.
16" x 20"	FS-2-1620	37"	26"	\$3256	100	20
	FS-2-1620-18RorL	52.5"	26"	3536	120	27
	FS-2-1620-18RL	68"	26"	3625	143	34
18" x 18"	FS-2-1818	41"	24"	3320	98	18
	FS-2-1818-18RorL	56.5"	24"	3572	110	26
	FS-2-1818-18RL	72"	24"	3753	125	30
18" x 24"	FS-2-1824	41"	30"	3493	149	26
	FS-2-1824-18RorL	56.5"	30"	3851	169	35
	FS-2-1824-24RorL	62.5"	30"	4285	190	39
	FS-2-1824-18RL	72"	30"	4403	220	44
	FS-2-1824-24RL	84"	30"	5097	240	51
24" x 24"	FS-2-2424	53"	30"	3847	179	33
	FS-2-2424-18RorL	68.5"	30"	4711	200	42
	FS-2-2424-24RorL	74.5"	30"	4827	220	46
	FS-2-2424-18RL	84"	30"	5080	245	51
	FS-2-2424-24RL	96"	30"	5443	270	58
30" x 24"	FS-2-3024	65"	30"	4764	265	40
	FS-2-3024-24RorL	86.5"	30"	5630	300	52
	FS-2-3024-24RL	108"	30"	5918	320	64

### FS Series: 3 Compartment Sinks

Bowl Size	Model #	O.A. Length	O.A. Width	Price	Wt.	Cu.
16" x 20"	FS-3-1620	53"	26"	\$4573	140	27
	FS-3-1620-18RorL	68.5"	26"	5089	160	35
	FS-3-1620-18RL	84"	26"	5585	155	36
	FS-3-1620-24RL	96"	26"	6008	235	47
	FS-3-1620-36RL	120"	26"	6217	280	59
18" x 18"	FS-3-1818	59"	24"	4764	130	25
	FS-3-1818-18RorL	75"	24"	5198	150	31
	FS-3-1818-18RL	90"	24"	5774	170	52
18" x 24"	FS-3-1824	59"	30"	4937	158	36
	FS-3-1824-18RorL	74.5"	30"	5545	174	46
	FS-3-1824-24RorL	80.5"	30"	5716	187	49
	FS-3-1824-18RL	90"	30"	6339	310	54
	FS-3-1824-24RL	102"	30"	6783	375	61
24" x 24"	FS-3-2424†	77"	30"	5557	329	47
	FS-3-2424-18RorL†	92.5"	30"	6199	353	56
	FS-3-2424-24RorL†	98.5"	30"	6350	369	59
	FS-3-2424-18RL†	108"	30"	7001	382	64
	FS-3-2424-24RL†	120"	30"	7145	405	71

† Requires Two Sets of Faucets



**Optional Front Cross-Bracing for FS Series Sinks**  
**FC-CB-1 \$34 per foot**

**Stainless Steel Leg with Bullet foot**  
**K-475 \$68 per leg**

**Stainless Steel Sink Covers**  
 See Page 33

**Removable 12" Side Splashes**  
 For FS & FC Series Sinks  
 Accommodates Left & right Sides

**K-700F-24 \$480 ea.**  
 For sinks with 24" front-to-back bowls

**K-700F-18 \$457 ea.**  
 For sinks with 18" front-to-back bowls

**K-700 \$457 ea.**  
 (For all other sink sizes)

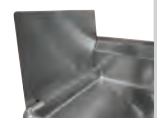

**Additional Sizes Available.**  
**See Modifications & Accessories on Pages 33 & 34**





**SUPER STURDY**  
CROSS BRACING

# FABRICATED Sinks

## 16 GAUGE FABRICATED SINKS

- 16 Ga. 304 Stainless Steel
- 14" Deep Bowls
- All Welded Super-Sturdy Cross-Bracing
- Tile Edge Splash
- Stainless Steel Legs & Adjustable Stainless Steel Bullet Feet

### FC Series: 1 Compartment Sinks

Bowl Size	Model #	O.A. Length	O.A. Width	Price	Wt.	Cu.
<b>16" x 20"</b>	FC-1-1620	21"	26"	\$1183	50	12
	FC-1-1620-18RorL	36.5"	26"	1894	65	20
	FC-1-1620-18RL	52"	26"	1957	80	27
<b>18" x 18"</b>	FC-1-1818	23"	24"	1156	60	11
	FC-1-1818-18RorL	38.5"	24"	1840	65	17
	FC-1-1818-18RL	54"	24"	1873	70	16
	FC-1-1818-24RorL	45"	24"	2106	90	25
	FC-1-1818-24RL	66"	24"	2176	100	28
<b>18" x 24"</b>	FC-1-1824	23"	30"	1344	67	34
	FC-1-1824-18RorL	38.5"	30"	2039	105	40
	FC-1-1824-24RorL	45"	30"	2146	115	19
	FC-1-1824-18RL	54"	30"	2107	120	28
	FC-1-1824-24RL	66"	30"	2184	130	34
<b>24" x 24"</b>	FC-1-2424	29"	30"	1429	90	19
	FC-1-2424-18RorL	44.5"	30"	2168	118	44
	FC-1-2424-24RorL	50.5"	30"	2349	123	32
	FC-1-2424-18RL	60"	30"	2300	135	35
	FC-1-2424-24RL	72"	30"	2426	145	45

### FC Series: 2 Compartment Sinks

Bowl Size	Model #	O.A. Length	O.A. Width	Price	Wt.	Cu.
<b>15" x 15"</b>	FC-2-1515	35"	21"	\$2006	78	11
<b>16" x 20"</b>	FC-2-1620	37"	26"	2308	85	20
	FC-2-1620-18RorL	52.5"	26"	2703	100	27
	FC-2-1620-18RL	68"	26"	2780	118	34
<b>18" x 18"</b>	FC-2-1818	41"	24"	2172	83	22
	FC-2-1818-18RorL	56.5"	24"	2514	90	30
	FC-2-1818-18RL	72"	24"	2662	105	37
	FC-2-1818-24RL	84"	24"	2860	118	43
<b>18" x 24"</b>	FC-2-1824	41"	30"	2334	115	27
	FC-2-1824-18RorL	56.5"	30"	2651	130	37
	FC-2-1824-24RorL	62.5"	30"	2899	140	40
	FC-2-1824-18RL	72"	30"	2981	145	45
<b>24" x 24"</b>	FC-2-2424	53"	30"	2545	138	34
	FC-2-2424-18RorL	68.5"	30"	3119	155	44
	FC-2-2424-24RorL	74.5"	30"	3236	195	47
	FC-2-2424-18RL	84"	30"	3173	210	53
	FC-2-2424-24RL	96"	30"	3318	225	60

## Fabricated Corner Sink

16 Gauge, 304 Stainless Steel



**FC-K6-18D \$5220**

- Welded Cross-Bracing
- S/S Legs & Bullet Feet
- Requires 2 Faucets (Not Included)
- 3 - 18" x 18" x 14" Bowls
- 2 - 18" x 18" Drainboards
- Wall Dimension: 57" x 57"
- 248 lbs. 66 Cu. Ft.

### FC Series: 3 Compartment Sinks

Bowl Size	Model #	O.A. Length	O.A. Width	Price	Wt.	Cu.
<b>15" x 15"</b>	FC-3-1515	50"	21"	\$2292	110	25
	FC-3-1515-15RorL	62.5"	21"	2458	120	31
	FC-3-1515-15RL	75"	21"	2526	130	52
<b>16" x 20"</b>	FC-3-1620	53"	26"	2789	120	27
	FC-3-1620-18RorL	68.5"	26"	2980	135	35
	FC-3-1620-18RL	84"	26"	3147	150	36
	FC-3-1620-24RL	96"	26"	3368	205	47
	FC-3-1620-36RL	120"	26"	3850	240	59
<b>18" x 18"</b>	FC-3-1818	59"	24"	2688	120	46
	FC-3-1818-18RorL	74.5"	24"	2857	128	49
	FC-3-1818-24RorL	80.5"	24"	2949	136	54
	FC-3-1818-18RL	90"	24"	2892	143	46
	FC-3-1818-24RL	102"	24"	3028	150	52
<b>18" x 24"</b>	FC-3-1824	59"	30"	2742	135	56
	FC-3-1824-18RorL	74.5"	30"	3234	142	59
	FC-3-1824-24RorL	80.5"	30"	3372	150	64
	FC-3-1824-18RL	90"	30"	3621	265	56
	FC-3-1824-24RL	102"	30"	3800	300	63
<b>24" x 24"</b>	†FC-3-2424	79"	30"	3035	175	48
	†FC-3-2424-18RorL	92.5"	30"	3955	310	58
	†FC-3-2424-24RorL	98.5"	30"	4124	330	61
	†FC-3-2424-24RL	120"	30"	4209	350	74
	†FC-3-2424-18RL	108"	30"	4085	330	67
<b>20" x 28"</b>	FC-3-2028-24RL	108"	34"	4673	315	75
<b>20" x 30"</b>	FC-3-2030-20RL	100"	36"	4244	315	73
	FC-3-2030-30RL	120"	36"	5252	370	81
<b>24" x 30"</b>	†FC-3-2430	77"	36"	3611	200	55
	†FC-3-2430-24RorL	99"	36"	4204	175	69
	†FC-3-2430-24RL	120"	36"	6231	400	84
	†FC-3-2430-30RorL	105"	36"	5515	425	74
	†FC-3-2430-30RL	132"	36"	6419	445	92
	†FC-3-2430-36RorL	111"	36"	5721	450	78
<b>30" x 24"</b>	†FC-3-2430-36RL	144"	36"	6506	490	101
	†FC-3-3024	95"	30"	4207	200	57
	†FC-3-3024-24RorL	117"	30"	5495	375	70
	†FC-3-3024-24RL	138"	30"	6304	400	82
	†FC-3-3024-30RorL	123"	30"	5759	425	73
	†FC-3-3024-30RL	150"	30"	6523	445	88
<b>30" x 24"</b>	†FC-3-3024-36RorL	129"	30"	5877	450	76
	†FC-3-3024-36RL	162"	30"	6753	450	95
	†FC-3-3030	95"	36"	5760	240	67
	†FC-3-3030-24RL	138"	36"	9748	470	96
	†FC-3-3030-30RL	150"	36"	10191	515	104
	†FC-3-3030-36RL	162"	36"	10303	560	112

### FC Series: 4 Compartment Sinks

Bowl Size	Model #	O.A. Length	O.A. Width	Price	Wt.	Cu.
<b>18" x 18"</b>	FC-4-1818-18RL†	108"	24"	\$4634	270	51
<b>18" x 24"</b>	FC-4-1824-18RL†	108"	30"	5161	325	62
<b>24" x 24"</b>	FC-4-2424-24RL†	144"	30"	6063	355	80

† Requires Two Sets of Faucets

Additional Sizes Available. See Modifications & Accessories on Pages 33 & 34

# BUDGET SINKS

## Budget Line Scullery Sinks

 = Ship Via UPS



18" - 21" Wide Sink Bowls Are 14" Deep  
24" Wide Sink Bowls Are 13" Deep

Includes 3 1/2" Basket Drain & 8" O.C. Faucet Holes

### 1 COMPARTMENT SINKS

Size	L	Wt.	Cu. Ft.	"400" Series (430 S/S)		"600" Series (300 S/S)	
				Model #	Price	Model #	Price
18" x 18"	18"	44 lbs.	8	4-81-18	\$1030	6-81-18	\$1182
21" x 18"	18"	47 lbs.	9	4-1-18	1048	6-1-18	1220
21" x 24"	24"	53 lbs.	12	4-1-24	1067	6-1-24	1336
21" x 36"	36"	66 lbs.	16	4-1-36	1220	6-1-36	1373
24" x 24"	24"	54 lbs.	12	4-41-24	1295	6-41-24	1431
24" x 36"	36"	69 lbs.	17	4-41-36	1386	6-41-36	1528

### 3 COMPARTMENT SINKS

Size	L	Wt.	Cu. Ft.	"400" Series (430 S/S)		"600" Series (300 S/S)	
				Model #	Price	Model #	Price
21" x 36"	36"	78 lbs.	16	4-3-36	\$1622	6-3-36	\$1813
21" x 48"	48"	91 lbs.	21	4-3-48	1758	6-3-48	2081
21" x 54"	54"	98 lbs.	24	4-3-54	1830	6-3-54	2136
** 21" x 72"	72"	115 lbs.	31	4-3-72	2368	6-3-72	2672
24" x 60"	60"	108 lbs.	27	4-43-60	2290	6-43-60	2577
** 24" x 72"	72"	118 lbs.	32	4-43-72	2445	6-43-72	2789

### 2 COMPARTMENT SINKS

Size	L	Wt.	Cu. Ft.	"400" Series (430 S/S)		"600" Series (300 S/S)	
				Model #	Price	Model #	Price
21" x 36"	36"	73 lbs.	16	4-2-36	\$1508	6-2-36	\$1698
21" x 48"	48"	86 lbs.	21	4-2-48	1642	6-2-48	1868
21" x 60"	60"	98 lbs.	26	4-2-60	2081	6-2-60	2176
24" x 48"	48"	88 lbs.	22	4-42-48	1813	6-42-48	2003
24" x 60"	60"	108 lbs.	27	4-42-60	2196	6-42-60	2482

### 4 COMPARTMENT SINKS

Size	L	Wt.	Cu. Ft.	"400" Series (430 S/S)		"600" Series (300 S/S)	
				Model #	Price	Model #	Price
†** 21" x 48"	48"	95 lbs.	21	4-4-48	\$1948	6-4-48	\$2251
** 21" x 60"	60"	113 lbs.	26	4-4-60	2482	6-4-60	2663
21" x 72"	72"	120 lbs.	21	4-4-72	2672	6-4-72	2865

† Quick-Drain Omitted In This Size \*\* Requires Two Faucets

For Residential Finish & Packaging, Add K-350 \$360

## BUDGET SINK ACCESSORIES

All Budget Sink Accessories Ship Via UPS



### Drainboards

- Drainboards 36" & Larger Supplied With Legs
- Sides & End Of Drainboard Turned Up with 2" Hemmed Edges Along Top

Model #	Size	Approx. Wt.	Approx. Cu. Ft.	Price
N-5-818	18" x 18"	13 lbs.	1	\$390
N-5-18	21" x 18"	15 lbs.	1	419
N-5-24	21" x 24"	18 lbs.	1	486
N-5-30	21" x 30"	22 lbs.	2	548
N-5-36	21" x 36"	25 lbs.	2	877
N-5-48	21" x 48"	28 lbs.	3	1049
N-54-24	24" x 24"	20 lbs.	1	522
N-54-36	24" x 36"	25 lbs.	2	922
N-54-48	24" x 48"	30 lbs.	3	1092

### Stainless Steel Sink Covers

For One Compartment Budget Sinks

Model #	Size	Price
LSC-81	18" x 18"	\$437
LSC-24	21" x 24"	437
LSC-242	24" x 24"	437
LSC-36	24" x 36"	437



Stores Conveniently On Side Of Sink

## MOBILE & SILVER SOAK SINKS



### Mobile Sinks

34" Working Height

A Multi-Purpose Unit.

Move it where the ACTION is! A must for the large food preparation type installation.

Model #	Bowl Size	Price	Approx. Wt.
9-FMS-20	22" x 22" x 8"	\$4010	50 lbs.
9-FMS-12	22" x 22" x 12"	4393	50 lbs.

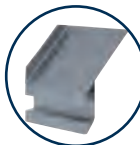

Optional Chute  
9-SS-1 \$463



Optional Bumpers  
9-SS-2 \$218

### Silver Soak Sinks

20" Working Height

UNIVERSAL BOWL SIZE.

Accommodates 19 3/4" x 19 3/4" Dishwasher Baskets

Model #	Bowl Size	Price	Approx. Wt.
9-FSS-20	22" x 22" x 8"	\$3831	42 lbs.



### Silver Soak Sinks with Detachable Chute

20" Working Height

Required for the Scullery operation that promotes clean sanitary flatware.

Model #	Bowl Size	Price	Approx. Wt.
9-FSC-20	22" x 22" x 8"	\$4202	50 lbs.

Shown with Optional Bumpers



# SINK MODS

## Sink Modifications & Accessories

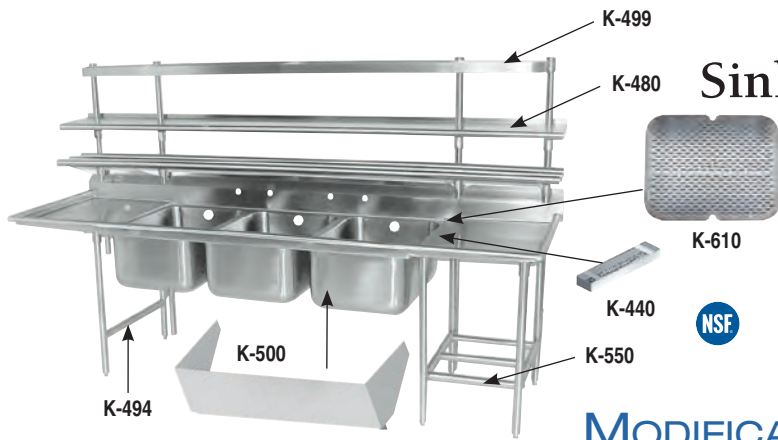

**K-37**  
Anti-Siphon Vacuum  
Breaker Holes



**K-72**  
Leg-To-Wall  
Brace



**K-460A**  
Disposal Cone w/  
Control Bracket &  
Faucet Holes

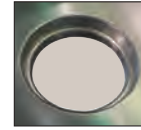

**K-461A**  
Install Collar  
w/ Control Bracket

## MODIFICATIONS

<b>K-4</b>	Support Bracket for Lever Waste Drain Handle	\$122 ea.
<b>K-23</b>	Sink Legs Welded To Undershelf Or Left-To-Right Cross Rails, Shipped Set Up & Crated. (Top Is Not Welded To Legs)	401 per sink
<b>K-23A</b>	Sink Legs Welded To Leg Gussets Under Sink Top & To Undershelf Or Left-To-Right Cross Rails, Shipped Set Up & Crated	506 per sink
<b>K-24</b>	Shell Crating	296
<b>K-37</b>	Anti-Siphon Vacuum Breaker Holes	121
<b>K-57</b>	Welded field Joint (Welded in field by others)	267 per sink
<b>K-76</b>	Paint on Sound Deadening	534
<b>K-77</b>	Splash Cutout (Pipe Chase)	189
<b>K-106</b>	Mirror Highlite Edge for Sink	415
<b>K-440</b>	Waste Trough with 2" deep removable basket	914
<b>K-447</b>	High Backsplash up to 18"	189 lin. ft.
<b>K-448</b>	High Backsplash up to 13"	152 lin. ft.
<b>K-450</b>	Extend Drainboard Length (Drainboards over 36" Are Not Creased or Pitched.)	385 lin. ft.
<b>K-451</b>	Drainboard Corner Turn	1342 ea.
<b>K-452</b>	Control Bracket 8" x 12"	267 ea.
<b>K-452S</b>	Splash Mounted Control Bracket 8" x 12"	303 ea.
<b>K-453</b>	Control Bracket 14" x 16"	287 ea.
<b>K-453S</b>	Splash Mounted Control Bracket 14" x 16"	335 ea.
<b>K-454</b>	Sidesplash	415 ea.
<b>K-456</b>	Scrap Block Installed	390
<b>K-460</b>	Installation of Disposal Cone with 8" x 12" Control Bracket, Faucet Holes (Cone supplied by others)	798 ea.

<b>K-460A</b>	Installation of Disposal Cone with 14" x 16" Control Bracket, Faucet Holes (Cone supplied by others)	\$848 ea.
<b>K-461</b>	Install Collar with 8" x 12" control bracket (Collar by others)	798
<b>K-461A</b>	Install Collar with 14" x 16" control bracket (Collar by others)	848
<b>K-470</b>	Modify Bowl Depth	173 ea.
<b>K-472</b>	Faucet Hole Revision	121 ea.
<b>K-473</b>	Working Height Revision	101 ea.
<b>K-476</b>	Punch for Over Flow Holes (Holes Only. N/C when ordering K-15)	55 ea.
<b>K-479</b>	Undershelf Under Drainboard	240 lin. ft.
<b>K-480</b>	Stainless Steel 12" Wide Shelf (min. of 3 ft.)	251 lin. ft.
<b>K-480A</b>	Stainless Steel 15" Wide Shelf (min. of 3 ft.)	360 lin. ft.
<b>K-490</b>	Provision for Pot Washer (For "Wells-PW-106" only)	968 ea.
<b>K-491</b>	Provision for Hatco Heater	190 ea.
<b>K-495</b>	Turn Down Backsplash (Includes 2 Brackets. See K-397 Add'l Sets)	166
<b>K-498</b>	Tubular Overshelf 12" wide (Min. 3 Ft.)	379 lin. ft.
<b>K-499</b>	Stainless Steel Pot Rack	300 lin. ft.
<b>K-500</b>	Stainless Steel Apron to Cover Sink Bowls	942 ea.
<b>K-500A</b>	17" Stainless Steel Apron to Cover Sink Bowls and Support Lever Drain Handles	1095 ea.
<b>K-508</b>	Special Sizing Charge (Larger size cut down to smaller size)	N/C ea.
<b>K-508A</b>	Special Modification Charge	254 ea.
<b>K-510</b>	Prepare Sink for Undercounter Dishwasher (24" drainboard or larger)	137 per sink
<b>K-520</b>	Poly Board/Stainless Steel Cover Holder	647 ea.
<b>K-550</b>	Stainless Steel Tubular Rack Storage	200 lin. ft.
<b>K-ROD</b>	Weld support rods for poly sink cover in corners of sink bowl	483 ea.

## ACCESSORIES

<b>K-30</b>	Faucet Wall Mounting Bracket	\$339 ea.
<b>K-72</b>	Leg To Wall Brace	297
<b>K-350</b>	Residential Finish & Packaging	360 ea.
<b>K-397</b>	Wall Bracket for Sink (Includes 2 Brackets with K-495 Mod.)	81 ea.
<b>K-457</b>	Replacement Rubber Scrap Block (See K-456 for install cost)	119 ea.
<b>K-474</b>	16 ga., '304' Series S/S Leg with S/S Foot	109 ea.
<b>K-475</b>	S/S Leg with S/S Foot	68 ea.
<b>K-477</b>	Replacement Leg Clamp for Adjustable Cross-Bracing	18 ea.
<b>K-477C</b>	Replacement Corner Leg Clamp for Adjustable Cross-Bracing	26 ea.
<b>K-478</b>	Stainless Steel Bullet Foot	27 ea.
<b>K-488</b>	Flanged S/S Bullet Foot	58 ea.
<b>K-493</b>	16 ga., '304' Series S/S Welded Leg Assembly with S/S Feet	363 ea.
<b>K-494</b>	S/S Welded Leg Assembly with S/S Feet	322 ea.
<b>K-497</b>	Galv. Welded Leg Assembly with Plastic Feet	216 ea.
<b>K-497A</b>	Galv. Individual Legs with Plastic Feet	78 set/4
<b>K-496</b>	Leg Assembly For Grease Interceptor w/ Adj. Cross-Bracing & S/S Feet (For Grease Interceptors with 15" Ht. or less. Consult factory for larger Grease Interceptors)	417 ea.
<b>K-610</b>	Perforated Stainless Steel Sink Grid (Specify Bowl Size)	727 ea.

## SINK COVERS

Choose Model # & Add The Proper Letter In Place Of The Underscore (\_).  
Example: K-2A or FC-455H

Bowl Size	FOR DEEP DRAW BOWLS		FOR FABRICATED BOWLS	
	Poly Covers Model K-2_ \$281	S/S Covers Model K-455_ \$471	Poly Covers Model K-2_ \$281	S/S Covers Model FC-455_ \$471
16" x 20"	C	C	CF	C
20" x 20"	E	E	EF	E
24" x 24"	F	F	FF	F
10" x 14"	A	A	AF	A
20" x 28"	G	G	GF	G
14" x 16"	B	B	BF	B
18" x 24"	D	D	DF	D
18" x 18"	Not Available	Not Available	JF	J
20" x 24"	Not Available	Not Available	PF	P
24" x 36"	Not Available	Not Available	RF	R
20" x 30"	Not Available	Not Available	SF	S
24" x 30"	Not Available	Not Available	TF	T
15" x 15"	Not Available	Not Available	MF	M
14" x 14"	H	H	HF	H
12" x 20"	I	I	IF	I

Custom Covers Available. Consult Factory.

**K-ROD** Welded Support Rods for Poly Sink Covers in Corners of Sink Bowl (Replaces Standard Support Clips) **\$483 per bowl**

## Tubular KD Wall Mounted Drainage Shelves

Model #	Size	Price	
<b>DT-6R-36</b>	3"	<b>\$987</b>	• Stainless Steel
<b>DT-6R-48</b>	4"	<b>1142</b>	• 15" Deep
<b>DT-6R-60</b>	5"	<b>1282</b>	• 1-5/8" Diameter Stainless Steel Tubing
<b>DT-6R-72</b>	6"	<b>1405</b>	



# FAUCETS & DRAINS

All Items On This Page Ship Via UPS

For Sinks & Dishtables

## EXTRA HEAVY DUTY FAUCETS

### PRERINSE FAUCETS Wall Bracket Included

**SPEC-LINE HEAVY DUTY Splash Mounted Prerinse Faucet**  
DTA-53 \$864



**Deck Mounted Prerinse Faucet**  
K-115 \$1199

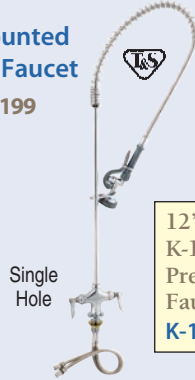

**Splash Mounted Prerinse Faucet**  
K-116 \$1199



12" Add-A-Faucet for DTA-53 Prerinse Faucets  
K-117 \$338



12" Add-A-Faucet for K-115 & K-116 Prerinse Faucets  
K-117-TS \$526



Replacement Hose Handle Not Included

K-113 \$164



Replacement Spray Head & Handle

K-114 \$186



Model #	Spout Size	T&S Equivalent	Price
K-11	14"	5F-8WLX14	\$274
K-101	8"	5F-8WLX08	215
K-105	14"	B-0230 w/1063X	415
K-112	12"	B-0231	301
K-119	16"	B-0230 W/064X	360
K-211	18"	5f-8WLX18	610

Interchangeable with T&S Brand Faucets. Carton Pricing Available

### POPULAR SPLASH MOUNTED FAUCETS

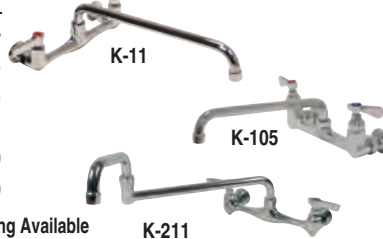

**Heavy Duty 14" Swing Spout**  
K-111 \$578

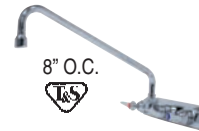

**Wrist Handles for Extra Heavy Duty & Standard 8" O.C. Faucets**  
Splash Mounted K-416-LU \$119



#### 12" Swing Spout Faucet



Standard K-1 \$234  
T&S Equivalent SF-8WLX12

#### Heavy Duty 8" Swing Spout Faucet



Standard K-1118 \$366  
T&S Equivalent B-1126

#### Heavy Duty Wall Mounted Service Faucet\*



K-240 \$877

#### Faucet Wall Mounting Bracket



K-30 \$339

For use when no backsplash is available to mount faucet

#### Low Flow Aerator



K-08 \$26

#### Faucet Mounting Kit for K-1, K-11, K-101, K-116, K-119, K-211 & DTA-53



K-06 \$93 (Set of 2)

#### Replacement Cartridges for K-1, K-11, K-101



K-00B \$103 (Set of 2)

Repair Kit can only be used on faucets purchased after 12/03

#### Replacement Cartridges for K-105 & K-112



K-07 \$125 (Set of 2)

#### Vacuum Breaker Repair Kit for K-240

K-03 \$122

#### Replacement Spouts

Model	Spout Size/Style	Price
K-101SP	8" Swing Spout	\$66
K-1SP	12" Swing Spout	79
K-11SP	14" Swing Spout	86
K-211SP	18" Swing Spout	184

#### Continuous Waste For 3 Compartment Sink



K-351 \$338  
For Use with 2 & 3 Compartment Sinks

#### Chrome Plated P-Trap



Heavy Gauge (17 Gauge) 7-PS-10 \$128  
Standard Gauge (22 Gauge) 7-PS-14 \$113

#### Replacement Floor Mop Sink Drain



K-16 \$169

#### Replacement Drains Assembly

K-6 \$44

Basket K-310 \$27

Strainer Plate for 3-1/2" Drain K-410 \$24

#### Twist Handle Operated Drain



K-5 \$265

Twist Drain Support Bracket K-4 \$122

#### Twist Handle Operated Drain with Overflow



K-15 \$469

#### SPEC-LINE Twist Handle Operated Drain



K-40 \$869

All Stainless Steel

#### Replacement "O" Rings for Twist Handle Operated Drains

For K-5 & K-15 Drains

K-05 \$18  
Washer for Twist Handle  
Stopper Washer

**WARNING:** Equipment that includes a faucet may expose you to chemicals, including lead, that are known to the State of California to cause cancer or birth defects or other reproductive harm. For more info., visit [www.p65warnings.ca.gov](http://www.p65warnings.ca.gov).



# FLOOR TROUGHS

## Floor Troughs & Floor Drains

Consult Factory For Additional Sizes  
Custom Sizes Available - Call For Pricing.

Ship Via UPS

- 14 Gauge 304 Stainless Steel
- Stainless Steel Or Fiberglass Grating
- Pitched Towards Waste
- Subway Grating Constructed From 3/16" X 1" Bars
- Grating Is Spaced 9/16" (Inside Clearance) Between Bars To Prevent Casters From Getting Trapped
- Includes 4" Od. - 3" Long Plumbing Sleeve
- Includes Stainless Steel Strainer Basket With Handle

	With S/S Grate	Price	Approx. Weight	With Fiberglass Grate	Price	Approx. Weight	Size W x L x D
12" Width	FTG-1224	\$2938	46 lbs.	FFTG-1224	\$2835	34 lbs.	12" x 24" x 4"
	FTG-1230	3028	56 lbs.	FFTG-1230	2918	37 lbs.	12" x 30" x 4"
	FTG-1236	3122	66 lbs.	FFTG-1236	3001	40 lbs.	12" x 36" x 4"
	FTG-1242	3324	76 lbs.	FFTG-1242	3184	43 lbs.	12" x 42" x 4"
	FTG-1248	3858	86 lbs.	FFTG-1248	3669	46 lbs.	12" x 48" x 4"
	FTG-1254	4187	96 lbs.	FFTG-1254	3968	49 lbs.	12" x 54" x 4"
	FTG-1260	4627	106 lbs.	FFTG-1260	4365	52 lbs.	12" x 60" x 4"
	FTG-1272	5318	116 lbs.	FFTG-1272	4995	55 lbs.	12" x 72" x 4"
	FTG-1284	6245	126 lbs.	FFTG-1284	5835	81 lbs.	12" x 84" x 4"
	FTG-1296*	6429	146 lbs.	FFTG-1296*	6003	90 lbs.	12" x 96" x 4"
	FTG-12108*	6980	166 lbs.	FFTG-12108*	6503	99 lbs.	12" x 108" x 4"
	FTG-12120*	8453	180 lbs.	FFTG-12120*	7835	108 lbs.	12" x 120" x 4"
18" Width	FTG-1824	3304	62 lbs.	FFTG-1824	3168	43 lbs.	18" x 24" x 4"
	FTG-1830	3488	74 lbs.	FFTG-1830	3336	47 lbs.	18" x 30" x 4"
	FTG-1836	3674	86 lbs.	FFTG-1836	3501	54 lbs.	18" x 36" x 4"
	FTG-1842	3931	98 lbs.	FFTG-1842	3738	61 lbs.	18" x 42" x 4"
	FTG-1848	4365	110 lbs.	FFTG-1848	4129	69 lbs.	18" x 48" x 4"
	FTG-1854	4918	122 lbs.	FFTG-1854	4631	76 lbs.	18" x 54" x 4"
	FTG-1860	5392	134 lbs.	FFTG-1860	5058	83 lbs.	18" x 60" x 4"
	FTG-1872	5903	146 lbs.	FFTG-1872	5524	90 lbs.	18" x 72" x 4"
	FTG-1884	7166	165 lbs.	FFTG-1884	6669	111 lbs.	18" x 84" x 4"
	FTG-1896*	7348	187 lbs.	FFTG-1896*	6834	125 lbs.	18" x 96" x 4"
	FTG-18108*	8453	208 lbs.	FFTG-18108*	7835	138 lbs.	18" x 108" x 4"
	FTG-18120*	9739	229 lbs.	FFTG-18120*	9004	150 lbs.	18" x 120" x 4"
24" Width	FTG-2424	4002	69 lbs.	FFTG-2424	3295	52 lbs.	24" x 24" x 4"
	FTG-2430	4167	81 lbs.	FFTG-2430	3585	59 lbs.	24" x 30" x 4"
	FTG-2436	4751	104 lbs.	FFTG-2436	3669	68 lbs.	24" x 36" x 4"
	FTG-2442	5002	118 lbs.	FFTG-2442	3960	75 lbs.	24" x 42" x 4"
	FTG-2448	5501	131 lbs.	FFTG-2448	4167	83 lbs.	24" x 48" x 4"
	FTG-2454	6003	145 lbs.	FFTG-2454	4668	95 lbs.	24" x 54" x 4"
	FTG-2460	6170	162 lbs.	FFTG-2460	5169	102 lbs.	24" x 60" x 4"
	FTG-2472	7172	195 lbs.	FFTG-2472	5668	119 lbs.	24" x 72" x 4"
	FTG-2484	7835	218 lbs.	FFTG-2484	6752	137 lbs.	24" x 84" x 4"
	FTG-2496*	8669	243 lbs.	FFTG-2496*	6920	153 lbs.	24" x 96" x 4"
	FTG-24108*	9840	274 lbs.	FFTG-24108*	8001	168 lbs.	24" x 108" x 4"
	FTG-24120*	10504	310 lbs.	FFTG-24120*	9169	188 lbs.	24" x 120" x 4"

\*96" or Longer Troughs Come with Two Drains

### Floor Trough Accessories & Modifications



Cut-Out View of Anti-Splash

**FT-1 \$108 lin. ft.**  
Optional Anti-Splash Guard (Factory Installed)



**FT-2 \$58 ea.**  
Replacement Stainless Steel Strainer Basket with Handle

**FT-3 \$117 lin. ft.**  
Modify Trough Depth (2" to 6" Deep)

**FT-4 \$246 per hole**  
Modify Drain Outlet Size (Allow 2" to 8" Dia)

**FT-5 \$125 lin. ft.**  
Grate Upgrade to A.D.A.  (2" to 8" Dia)

**FT-6 No Charge**  
Modify Length of Trough (Select Next Larger Size)

### Floor Drains



Includes Strainer Basket

Model #	Grate (Not Included)	Approx. Weight	Price	Size W x L x D
FD-1212	Stainless Steel	26 lbs.	\$1470	12" x 12" x 4"

**FD-1**  
Optional Stainless Steel Grate \$641

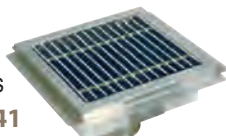

### Floor Water Receptacle



- 14 Gauge 304 Stainless Steel
- Includes Stainless Steel Subway Grating constructed from 3/16" x 1" bars

Model #	Size W x L x D	Price	Approx. Weight
FRG-24	12" x 24" x 2"	\$2839	44 lbs.
FRG-36	12" x 36" x 2"	3237	63 lbs.
FRG-48	12" x 48" x 2"	3751	82 lbs.

# TABLES

## Flat Top W/ Undershef

Stainless Steel TOP  
Stainless Steel UNDERSHELF  
Stainless Steel LEGS



Take Our Tables To  
New Heights!

### ADJUSTABLE TABLE HEIGHT UPGRADE

(Up to 6' tables only. Ships set up.)

- Add To Any Tubular Leg Style Table with Undershef
- Adjust Table Height From 31 1/2" - 40 1/2"
- Easy Turning, Non-Obstructive Fold Away Handle

TA-900  
\$4653 ea.

Up to 40 1/2"  
Max. Ht.  
From Floor

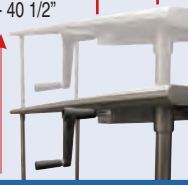

VSS Series  
Countertop Edge

Ship Via UPS



SS, MS, SAG Series  
Bull Nose Edge

### Spec-Line

### Premium

### Standard

### Super Saver

14 Ga. 304 S/S

14 Ga. 304 S/S

16 Ga. 304 S/S

16 Ga. 430 S/S

Length	Spec-Line			Premium			Standard			Super Saver			Approx. Shipping Weight	Approx. Cubic Feet
	Model #	Price	Model #	Price	Model #	Price	Model #	Price	Model #	Price				
<b>24" WIDE</b>	2'	VSS-242	\$1709	SS-242	\$1142	MS-242	\$1058	SAG-242	\$1027			31 lbs.	3	
	30"	VSS-240	1838	SS-240	1267	MS-240	1169	SAG-240	1120			49 lbs.	4	
	3'	VSS-243	1901	SS-243	1335	MS-243	1235	SAG-243	1183			64 lbs.	5	
	4'	VSS-244	1957	SS-244	1393	MS-244	1282	SAG-244	1215			79 lbs.	6	
	5'	VSS-245	2086	SS-245	1517	MS-245	1389	SAG-245	1316			92 lbs.	8	
	6'	VSS-246	2212	SS-246	1644	MS-246	1502	SAG-246	1411			109 lbs.	9	
	7'	VSS-247	2735	SS-247	2254	MS-247	2067	SAG-247	1740			130 lbs.	11	
	8'	VSS-248	2893	SS-248	2416	MS-248	2211	SAG-248	1871			145 lbs.	12	
	9'	VSS-249	3400	SS-249	3105	MS-249	2964	SAG-249	2666			161 lbs.	14	
	10'	VSS-2410	3620	SS-2410	3323	MS-2410	3036	SAG-2410	2882			261 lbs.	26	
	11'	VSS-2411	3931	SS-2411	3562	MS-2411	3241	SAG-2411	3056			293 lbs.	29	
	12'	VSS-2412	4010	SS-2412	3639	MS-2412	3321	SAG-2412	3135			308 lbs.	32	
<b>30" WIDE</b>	2'	VSS-302	1838	SS-302	1267	MS-302	1169	SAG-302	1120			55 lbs.	4	
	30"	VSS-300	1913	SS-300	1345	MS-300	1242	SAG-300	1166			65 lbs.	5	
	3'	VSS-303	1979	SS-303	1413	MS-303	1303	SAG-303	1246			72 lbs.	6	
	4'	VSS-304	2060	SS-304	1498	MS-304	1371	SAG-304	1295			89 lbs.	8	
	5'	VSS-305	2214	SS-305	1647	MS-305	1512	SAG-305	1419			107 lbs.	9	
	6'	VSS-306	2454	SS-306	1724	MS-306	1555	SAG-306	1538			126 lbs.	11	
	7'	VSS-307	2828	SS-307	2245	MS-307	2055	SAG-307	1808			148 lbs.	13	
	8'	VSS-308	2944	SS-308	2485	MS-308	2333	SAG-308	2027			166 lbs.	15	
	9'	VSS-309	3728	SS-309	3360	MS-309	3060	SAG-309	2862			176 lbs.	17	
	10'	VSS-3010	3945	SS-3010	3578	MS-3010	3276	SAG-3010	3083			287 lbs.	32	
	11'	VSS-3011	4232	SS-3011	3871	MS-3011	3531	SAG-3011	3302			324 lbs.	35	
	12'	VSS-3012	4311	SS-3012	3952	MS-3012	3613	SAG-3012	3378			339 lbs.	37	
<b>36" WIDE</b>	3'	VSS-363	2358	SS-363	1663	MS-363	1565	SAG-363	1443			88 lbs.	7	
	4'	VSS-364	2406	SS-364	1709	MS-364	1615	SAG-364	1493			98 lbs.	9	
	5'	VSS-365	2585	SS-365	1888	MS-365	1775	SAG-365	1656			118 lbs.	11	
	6'	VSS-366	2773	SS-366	2059	MS-366	1937	SAG-366	1813			138 lbs.	13	
	7'	VSS-367	3386	SS-367	2791	MS-367	2636	SAG-367	2505			164 lbs.	16	
	8'	VSS-368	3597	SS-368	2996	MS-368	2823	SAG-368	2704			184 lbs.	18	
	9'	VSS-369	4380	SS-369	3999	MS-369	3740	SAG-369	3515			190 lbs.	20	
	10'	VSS-3610	4595	SS-3610	4215	MS-3610	3959	SAG-3610	3735			308 lbs.	38	
	11'	VSS-3611	4936	SS-3611	4565	MS-3611	4274	SAG-3611	4004			358 lbs.	41	
	12'	VSS-3612	5016	SS-3612	4638	MS-3612	4350	SAG-3612	4081			373 lbs.	45	
	<b>48" WIDE</b>	4'	VSS-484	4403	SS-484	3418	<b>NOT AVAILABLE</b>						158 lbs.	12
		5'	VSS-485	4765	SS-485	3776							184 lbs.	15
6'		VSS-486	5118	SS-486	4125							218 lbs.	17	
7'		VSS-487	6567	SS-487	5581							260 lbs.	20	
8'		VSS-488	7014	SS-488	6022							290 lbs.	23	
9'		VSS-489	8130	SS-489	7080							322 lbs.	44	
10'		VSS-4810	8269	SS-4810	7218							522 lbs.	49	
11'		VSS-4811	8407	SS-4811	7356							601 lbs.	54	
12'		VSS-4812	8547	SS-4812	7495							616 lbs.	58	

Featuring as Standard: "THE PROVEN"  
Original ADVANCE TABCO Adjustable  
Undershelf with Die Cast Leg Clamp



# TABLES

## Flat Top W/ Undershef



VLG Series  
Countertop Edge



GLG, MG, AG Series  
Bull Nose Edge



Stainless Steel TOP  
Galvanized UNDERSHELF  
Galvanized LEGS

### Spec-Line

### Premium

### Standard

### Super Saver

14 Ga. 304 S/S

14 Ga. 304 S/S

16 Ga. 304 S/S

16 Ga. 430 S/S

Approx.  
Shipping  
Weight

Approx.  
Cubic  
Feet

Length	Model #	Price	Model #	Price	Model #	Price	Model #	Price	Approx. Shipping Weight	Approx. Cubic Feet	
<b>24" WIDE</b>	2' VLG-242	\$1371	GLG-242	\$819	MG-242	\$781	AG-242	\$729	31 lbs.	3	
	30" VLG-240	1467	GLG-240	904	MG-240	849	AG-240	793	49 lbs.	4	
	3' VLG-243	1532	GLG-243	973	MG-243	915	AG-243	859	64 lbs.	5	
	4' VLG-244	1560	GLG-244	987	MG-244	933	AG-244	877	79 lbs.	6	
	5' VLG-245	1647	GLG-245	1082	MG-245	1010	AG-245	925	92 lbs.	8	
	6' VLG-246	1751	GLG-246	1175	MG-246	1093	AG-246	987	109 lbs.	9	
	7' VLG-247	2137	GLG-247	1600	MG-247	1568	AG-247	1261	130 lbs.	11	
	8' VLG-248	2259	GLG-248	1719	MG-248	1679	AG-248	1436	145 lbs.	12	
	9' VLG-249	2584	GLG-249	2140	MG-249	2008	AG-249	1923	161 lbs.	14	
	10' VLG-2410	2806	GLG-2410	2354	MG-2410	2228	AG-2410	2140	261 lbs.	26	
	11' VLG-2411	3033	GLG-2411	2511	MG-2411	2354	AG-2411	2148	293 lbs.	29	
	12' VLG-2412	3115	GLG-2412	2591	MG-2412	2433	AG-2412	2229	308 lbs.	32	
<b>30" WIDE</b>	2' VLG-302	1467	GLG-302	904	MG-302	849	AG-302	793	55 lbs.	4	
	30" VLG-300	1505	GLG-300	936	MG-300	880	AG-300	812	65 lbs.	5	
	3' VLG-303	1570	GLG-303	1001	MG-303	945	AG-303	879	72 lbs.	6	
	4' VLG-304	1611	GLG-304	1040	MG-304	975	AG-304	895	89 lbs.	8	
	5' VLG-305	1728	GLG-305	1147	MG-305	1073	AG-305	979	107 lbs.	9	
	6' VLG-306	1844	GLG-306	1256	MG-306	1175	AG-306	1058	125 lbs.	11	
	7' VLG-307	2231	GLG-307	1691	MG-307	1592	AG-307	1326	148 lbs.	13	
	8' VLG-308	2388	GLG-308	1846	MG-308	1731	AG-308	1536	166 lbs.	15	
	9' VLG-309	2828	GLG-309	2314	MG-309	2168	AG-309	1951	176 lbs.	17	
	10' VLG-3010	3044	GLG-3010	2526	MG-3010	2389	AG-3010	2171	287 lbs.	32	
	11' VLG-3011	3245	GLG-3011	2772	MG-3011	2549	AG-3011	2305	324 lbs.	35	
	12' VLG-3012	3326	GLG-3012	2794	MG-3012	2629	AG-3012	2388	339 lbs.	37	
<b>36" WIDE</b>	3' VLG-363	1890	GLG-363	1176	MG-363	1136	AG-363	1036	88 lbs.	7	
	4' VLG-364	1939	GLG-364	1219	MG-364	1185	AG-364	1111	98 lbs.	9	
	5' VLG-365	2087	GLG-365	1371	MG-365	1329	AG-365	1255	118 lbs.	11	
	6' VLG-366	2228	GLG-366	1492	MG-366	1443	AG-366	1371	138 lbs.	13	
	7' VLG-367	2686	GLG-367	2016	MG-367	1966	AG-367	1889	164 lbs.	16	
	8' VLG-368	2815	GLG-368	2141	MG-368	2081	AG-368	2008	184 lbs.	18	
	9' VLG-369	3357	GLG-369	2792	MG-369	2715	AG-369	2472	190 lbs.	20	
	10' VLG-3610	3577	GLG-3610	3014	MG-3610	2932	AG-3610	2680	308 lbs.	38	
	11' VLG-3611	3809	GLG-3611	3268	MG-3611	3147	AG-3611	2852	358 lbs.	41	
	12' VLG-3612	3891	GLG-3612	3345	MG-3612	3221	AG-3612	2928	373 lbs.	45	
	<b>48" WIDE</b>	4' VLG-484	3929	GLG-484	2946	<b>NOT AVAILABLE</b>				158 lbs.	12
		5' VLG-485	4275	GLG-485	3295					184 lbs.	15
6' VLG-486		4557	GLG-486	3299	218 lbs.					17	
7' VLG-487		5834	GLG-487	4851	260 lbs.					20	
8' VLG-488		6125	GLG-488	5136	290 lbs.					23	
9' VLG-489		7185	GLG-489	6139	322 lbs.					44	
10' VLG-4810		7328	GLG-4810	6278	522 lbs.					49	
11' VLG-4811		7466	GLG-4811	6418	601 lbs.					54	
12' VLG-4812	7604	GLG-4812	6554	616 lbs.	58						

# TABLES

## Flat Top W/ Open Base

Stainless Steel TOP  
Stainless Steel LEGS



**Take Our Tables To New Heights!**

**ADJUSTABLE TABLE HEIGHT UPGRADE**  
(Up to 6' tables only. Ships set up.)

- Add To Any Tubular Leg Style Table with Undershelf
- Adjust Table Height From 31 1/2" - 40 1/2"
- Easy Turning, Non-Obstructive Fold Away Handle

**TA-900**  
**\$4653 ea.**

Up to 40 1/2" Max. Ht. From Floor



**Spec-Line Premium Standard Super Saver**

14 Ga. 304 S/S      14 Ga. 304 S/S      16 Ga. 304 S/S      16 Ga. 430 S/S

Length	Model #	Price	Model #	Price	Model #	Price	Model #	Price	Approx. Shipping Weight	Approx. Cubic Feet
<b>24" WIDE</b>	2'	TVSS-242 \$1834	TSS-242 \$1264	TMS-242 \$1182	TSAG-242 \$1147	25 lbs.	3			
	30"	TVSS-240 1957	TSS-240 1393	TMS-240 1290	TSAG-240 1243	42 lbs.	4			
	3'	TVSS-243 2027	TSS-243 1460	TMS-243 1355	TSAG-243 1307	53 lbs.	5			
	4'	TVSS-244 2083	TSS-244 1516	TMS-244 1404	TSAG-244 1339	64 lbs.	6			
	5'	TVSS-245 2210	TSS-245 1642	TMS-245 1512	TSAG-245 1431	74 lbs.	8			
	6'	TVSS-246 2340	TSS-246 1769	TMS-246 1628	TSAG-246 1533	85 lbs.	9			
	7'	TVSS-247 2856	TSS-247 2373	TMS-247 2193	TSAG-247 1865	103 lbs.	11			
	8'	TVSS-248 3019	TSS-248 2538	TMS-248 2339	TSAG-248 1993	114 lbs.	12			
	9'	TVSS-249 3532	TSS-249 3238	TMS-249 2952	TSAG-249 2792	130 lbs.	14			
	10'	TVSS-2410 3751	TSS-2410 3456	TMS-2410 3168	TSAG-2410 3014	227 lbs.	26			
	11'	TVSS-2411 4060	TSS-2411 3693	TMS-2411 3376	TSAG-2411 3187	251 lbs.	29			
	12'	TVSS-2412 4142	TSS-2412 3771	TMS-2412 3453	TSAG-2412 3264	266 lbs.	32			
<b>30" WIDE</b>	2'	TVSS-302 1889	TSS-302 1322	TMS-302 1229	TSAG-302 1189	47 lbs.	4			
	30"	TVSS-300 2037	TSS-300 1471	TMS-300 1366	TSAG-300 1300	52 lbs.	5			
	3'	TVSS-303 2102	TSS-303 1536	TMS-303 1427	TSAG-303 1370	59 lbs.	6			
	4'	TVSS-304 2190	TSS-304 1624	TMS-304 1493	TSAG-304 1421	72 lbs.	8			
	5'	TVSS-305 2342	TSS-305 1775	TMS-305 1635	TSAG-305 1542	85 lbs.	9			
	6'	TVSS-306 2577	TSS-306 1930	TMS-306 1769	TSAG-306 1663	93 lbs.	11			
	7'	TVSS-307 2956	TSS-307 2475	TMS-307 2283	TSAG-307 1931	113 lbs.	13			
	8'	TVSS-308 3066	TSS-308 2735	TMS-308 2512	TSAG-308 2148	126 lbs.	15			
	9'	TVSS-309 3860	TSS-309 3492	TMS-309 3189	TSAG-309 2995	150 lbs.	17			
	10'	TVSS-3010 4074	TSS-3010 3707	TMS-3010 3407	TSAG-3010 3215	261 lbs.	32			
	11'	TVSS-3011 4366	TSS-3011 4001	TMS-3011 3660	TSAG-3011 3431	268 lbs.	35			
	12'	TVSS-3012 4443	TSS-3012 4079	TMS-3012 3738	TSAG-3012 3507	283 lbs.	37			
<b>36" WIDE</b>	3'	TVSS-363 2483	TSS-363 1787	TMS-363 1688	TSAG-363 1568	75 lbs.	7			
	4'	TVSS-364 2532	TSS-364 1834	TMS-364 1738	TSAG-364 1622	82 lbs.	9			
	5'	TVSS-365 2711	TSS-365 2009	TMS-365 1897	TSAG-365 1779	96 lbs.	11			
	6'	TVSS-366 2900	TSS-366 2189	TMS-366 2059	TSAG-366 1937	108 lbs.	13			
	7'	TVSS-367 3511	TSS-367 2906	TMS-367 2750	TSAG-367 2632	127 lbs.	16			
	8'	TVSS-368 3721	TSS-368 3123	TMS-368 2952	TSAG-368 2822	140 lbs.	18			
	9'	TVSS-369 4512	TSS-369 4129	TMS-369 3873	TSAG-369 3646	165 lbs.	20			
	10'	TVSS-3610 4726	TSS-3610 4346	TMS-3610 4090	TSAG-3610 3865	261 lbs.	38			
	11'	TVSS-3611 5066	TSS-3611 4685	TMS-3611 4403	TSAG-3611 4138	290 lbs.	41			
	12'	TVSS-3612 5144	TSS-3612 4772	TMS-3612 4487	TSAG-3612 4215	305 lbs.	45			
	<b>48" WIDE</b>	4'	TVSS-484 4527	TSS-484 3537	<b>NOT AVAILABLE</b>		128 lbs.	12		
		5'	TVSS-485 4892	TSS-485 3905			148 lbs.	15		
6'		TVSS-486 5236	TSS-486 4248	170 lbs.			17			
7'		TVSS-487 6693	TSS-487 5703	206 lbs.			20			
8'		TVSS-488 7133	TSS-488 6148	228 lbs.			23			
9'		TVSS-489 8255	TSS-489 7214	260 lbs.			44			
10'		TVSS-4810 8395	TSS-4810 7352	454 lbs.			49			
11'		TVSS-4811 8532	TSS-4811 7491	517 lbs.			54			
12'	TVSS-4812 8673	TSS-4812 7630	532 lbs.	58						



# TABLES

## Flat Top W/ Open Base



TGLG, TMG, TAG Series  
Bullnose Edge



TVLG Series  
Countertop Edge



Stainless Steel TOP  
Galvanized LEGS

Length	Spec-Line		Premium		Standard		Super Saver		Approx. Shipping Weight	Approx. Cubic Feet		
	Model #	Price	Model #	Price	Model #	Price	Model #	Price				
	14 Ga. 304 S/S		14 Ga. 304 S/S		16 Ga. 304 S/S		16 Ga. 430 S/S					
<b>24" WIDE</b>	2'	TVLG-242	\$1493	TGLG-242	\$939	TMG-242	\$903	TAG-242	\$852	25 lbs.	3	
	30"	TVLG-240	1591	TGLG-240	1029	TMG-240	975	TAG-240	915	42 lbs.	4	
	3'	TVLG-243	1653	TGLG-243	1093	TMG-243	1036	TAG-243	982	53 lbs.	5	
	4'	TVLG-244	1683	TGLG-244	1113	TMG-244	1050	TAG-244	998	64 lbs.	6	
	5'	TVLG-245	1775	TGLG-245	1205	TMG-245	1131	TAG-245	1048	74 lbs.	8	
	6'	TVLG-246	1874	TGLG-246	1293	TMG-246	1215	TAG-246	1113	85 lbs.	9	
	7'	TVLG-247	2262	TGLG-247	1727	TMG-247	1691	TAG-247	1385	103 lbs.	11	
	8'	TVLG-248	2381	TGLG-248	1840	TMG-248	1804	TAG-248	1563	114 lbs.	12	
	9'	TVLG-249	2715	TGLG-249	2403	TMG-249	2137	TAG-249	2049	130 lbs.	14	
	10'	TVLG-2410	2932	TGLG-2410	2623	TMG-2410	2351	TAG-2410	2267	227 lbs.	26	
	11'	TVLG-2411	3164	TGLG-2411	2645	TMG-2411	2491	TAG-2411	2277	251 lbs.	29	
	12'	TVLG-2412	3242	TGLG-2412	2721	TMG-2412	2570	TAG-2412	2354	266 lbs.	32	
<b>30" WIDE</b>	2'	TVLG-302	\$1514	TGLG-302	952	TMG-302	906	TAG-302	860	47 lbs.	4	
	30"	TVLG-300	1629	TGLG-300	1058	TMG-300	1005	TAG-300	938	52 lbs.	5	
	3'	TVLG-303	1692	TGLG-303	1126	TMG-303	1073	TAG-303	1003	59 lbs.	6	
	4'	TVLG-304	1734	TGLG-304	1168	TMG-304	1096	TAG-304	1020	72 lbs.	8	
	5'	TVLG-305	1852	TGLG-305	1275	TMG-305	1193	TAG-305	1103	85 lbs.	9	
	6'	TVLG-306	1971	TGLG-306	1381	TMG-306	1293	TAG-306	1182	93 lbs.	11	
	7'	TVLG-307	2357	TGLG-307	1813	TMG-307	1710	TAG-307	1446	113 lbs.	13	
	8'	TVLG-308	2513	TGLG-308	1973	TMG-308	1855	TAG-308	1660	126 lbs.	15	
	9'	TVLG-309	2959	TGLG-309	2437	TMG-309	2295	TAG-309	2087	150 lbs.	17	
	10'	TVLG-3010	3175	TGLG-3010	2661	TMG-3010	2512	TAG-3010	2305	261 lbs.	32	
	11'	TVLG-3011	3378	TGLG-3011	2842	TMG-3011	2679	TAG-3011	2432	268 lbs.	35	
	12'	TVLG-3012	3460	TGLG-3012	2923	TMG-3012	2756	TAG-3012	2511	283 lbs.	37	
<b>36" WIDE</b>	3'	TVLG-363	2012	TGLG-363	1295	TMG-363	1257	TAG-363	1185	75 lbs.	7	
	4'	TVLG-364	2060	TGLG-364	1344	TMG-364	1308	TAG-364	1240	82 lbs.	9	
	5'	TVLG-365	2211	TGLG-365	1493	TMG-365	1451	TAG-365	1379	96 lbs.	11	
	6'	TVLG-366	2354	TGLG-366	1615	TMG-366	1568	TAG-366	1493	108 lbs.	13	
	7'	TVLG-367	2812	TGLG-367	2142	TMG-367	2086	TAG-367	2011	127 lbs.	16	
	8'	TVLG-368	2941	TGLG-368	2264	TMG-368	2201	TAG-368	2106	140 lbs.	18	
	9'	TVLG-369	3487	TGLG-369	2926	TMG-369	2846	TAG-369	2598	165 lbs.	20	
	10'	TVLG-3610	3705	TGLG-3610	3145	TMG-3610	3064	TAG-3610	2813	261 lbs.	38	
	11'	TVLG-3611	3945	TGLG-3611	3401	TMG-3611	3276	TAG-3611	2980	290 lbs.	41	
	12'	TVLG-3612	4024	TGLG-3612	3479	TMG-3612	3356	TAG-3612	3063	305 lbs.	45	
	<b>48" WIDE</b>	4'	TVLG-484	4031	TGLG-484	3067	<b>NOT AVAILABLE</b>				128 lbs.	12
		5'	TVLG-485	4403	TGLG-485	3418					148 lbs.	15
6'		TVLG-486	4772	TGLG-486	3700	170 lbs.					17	
7'		TVLG-487	5962	TGLG-487	4976	206 lbs.					20	
8'		TVLG-488	6243	TGLG-488	5256	228 lbs.					23	
9'		TVLG-489	7313	TGLG-489	6266	260 lbs.					44	
10'		TVLG-4810	7453	TGLG-4810	6406	454 lbs.					49	
11'		TVLG-4811	7594	TGLG-4811	6544	517 lbs.					54	
12'	TVLG-4812	7732	TGLG-4812	6684	532 lbs.	58						

# TABLES

## 1-1/2" Rear Splash W/ Undershef

Stainless Steel TOP  
Stainless Steel UNDERSHELF  
Stainless Steel LEGS

### Take Our Tables To New Heights!

#### ADJUSTABLE TABLE HEIGHT UPGRADE

(Up to 6' tables only. Ships set up.)

- Add To Any Tubular Leg Style Table with Undershef
- Adjust Table Height From 31 1/2"- 40 1/2"
- Easy Turning, Non-Obstructive Fold Away Handle

**TA-900**

**\$4653 ea.**

Up to 40 1/2"  
Max. Ht.  
From Floor

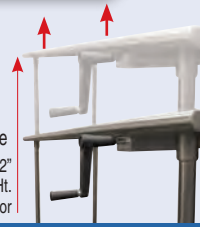

FSS, FMS, SFG Series  
Bullnose Edge

NSF

### Premium

### Standard

### Super Saver

14 Ga. 304 S/S

16 Ga. 304 S/S

16 Ga. 430 S/S

Approx. Shipping Weight  
Approx. Cubic Feet

Length	Model #	Price	Model #	Price	Model #	Price	Approx. Shipping Weight	Approx. Cubic Feet
<b>24" WIDE</b>	2' FSS-242	\$1243	FMS-242	\$1156	SFG-242	\$1127	31 lbs.	3
	30" FSS-240	1370	FMS-240	1262	SFG-240	1216	49 lbs.	4
	3' FSS-243	1431	FMS-243	1329	SFG-243	1287	64 lbs.	5
	4' FSS-244	1492	FMS-244	1377	SFG-244	1318	79 lbs.	6
	5' FSS-245	1622	FMS-245	1486	SFG-245	1411	92 lbs.	8
	6' FSS-246	1746	FMS-246	1596	SFG-246	1508	109 lbs.	9
	7' FSS-247	2352	FMS-247	2163	SFG-247	1839	130 lbs.	11
	8' FSS-248	2512	FMS-248	2305	SFG-248	1973	145 lbs.	12
	9' FSS-249	3208	FMS-249	2926	SFG-249	2773	161 lbs.	14
	10' FSS-2410	3430	FMS-2410	3145	SFG-2410	2983	261 lbs.	26
	11' FSS-2411	3666	FMS-2411	3344	SFG-2411	3158	293 lbs.	29
	12' FSS-2412	3742	FMS-2412	3423	SFG-2412	3240	308 lbs.	32
<b>30" WIDE</b>	2' FSS-302	1293	FMS-302	1206	SFG-302	1169	55 lbs.	4
	30" FSS-300	1443	FMS-300	1339	SFG-300	1284	65 lbs.	5
	3' FSS-303	1508	FMS-303	1407	SFG-303	1344	72 lbs.	6
	4' FSS-304	1595	FMS-304	1471	SFG-304	1394	89 lbs.	8
	5' FSS-305	1751	FMS-305	1608	SFG-305	1516	107 lbs.	9
	6' FSS-306	1907	FMS-306	1746	SFG-306	1637	125 lbs.	11
	7' FSS-307	2454	FMS-307	2256	SFG-307	1910	148 lbs.	13
	8' FSS-308	2706	FMS-308	2491	SFG-308	2122	166 lbs.	15
	9' FSS-309	3471	FMS-309	3165	SFG-309	2973	176 lbs.	17
	10' FSS-3010	3683	FMS-3010	3379	SFG-3010	3187	287 lbs.	32
	11' FSS-3011	3971	FMS-3011	3633	SFG-3011	3406	324 lbs.	35
	12' FSS-3012	4056	FMS-3012	3712	SFG-3012	3482	339 lbs.	37
<b>36" WIDE</b>	3' FSS-363	1761	FMS-363	1666	SFG-363	1544	88 lbs.	7
	4' FSS-364	1808	FMS-364	1710	SFG-364	1593	98 lbs.	9
	5' FSS-365	1986	FMS-365	1874	SFG-365	1756	118 lbs.	11
	6' FSS-366	2157	FMS-366	2037	SFG-366	1913	138 lbs.	13
	7' FSS-367	2889	FMS-367	2735	SFG-367	2602	164 lbs.	16
	8' FSS-368	3102	FMS-368	2924	SFG-368	2799	184 lbs.	18
	9' FSS-369	4103	FMS-369	3842	SFG-369	3618	190 lbs.	20
	10' FSS-3610	4318	FMS-3610	4060	SFG-3610	3840	223 lbs.	38
	11' FSS-3611	4664	FMS-3611	4376	SFG-3611	4107	350 lbs.	41
	12' FSS-3612	4746	FMS-3612	4457	SFG-3612	4190	365 lbs.	45

Units 8 ft. and larger furnished with 6 legs. **SPECIAL LENGTHS:** Select next largest size. Add **Model # TA-61 No Charge** (ex. SS-306 with TA-61 size to 66" long).

**Adjustable Single and Double Table Mounted Overshelves**  
See Pages 72.

**For Adjustable Components Featuring Potracks & Overshelves**  
10", 12" 15" & 18"  
See Page 78 & 79.



Featuring as Standard: "THE PROVEN"  
Original ADVANCE TABCO Adjustable Undershelf  
with Die Cast Leg Clamp

# TABLES

## 1-1/2" Rear Splash W/ Undershelf



FLG, FMG, FAG Series  
Bullnose Edge

Stainless Steel TOP  
Galvanized UNDERSHELF  
Galvanized LEGS

### Premium

### Standard

### Super Saver

14 Ga. 304 S/S

16 Ga. 304 S/S

16 Ga. 430 S/S

Approx. Shipping Weight    Approx. Cubic Feet

Length	Model #	Price	Model #	Price	Model #	Price	Approx. Shipping Weight	Approx. Cubic Feet
<b>24" WIDE</b>	2' FLG-242	\$915	FMG-242	\$879	FAG-242	\$825	31 lbs.	3
	30" FLG-240	1005	FMG-240	945	FAG-240	893	49 lbs.	4
	3' FLG-243	1073	FMG-243	1012	FAG-243	954	64 lbs.	5
	4' FLG-244	1090	FMG-244	1029	FAG-244	968	79 lbs.	6
	5' FLG-245	1181	FMG-245	1106	FAG-245	1026	92 lbs.	8
	6' FLG-246	1267	FMG-246	1189	FAG-246	1090	109 lbs.	9
	7' FLG-247	1701	FMG-247	1671	FAG-247	1363	130 lbs.	11
	8' FLG-248	1814	FMG-248	1779	FAG-248	1538	145 lbs.	12
	9' FLG-249	2249	FMG-249	2113	FAG-249	2023	161 lbs.	14
	10' FLG-2410	2462	FMG-2410	2330	FAG-2410	2241	261 lbs.	26
	11' FLG-2411	2621	FMG-2411	2462	FAG-2411	2296	293 lbs.	29
	12' FLG-2412	2701	FMG-2412	2543	FAG-2412	2332	308 lbs.	32
<b>30" WIDE</b>	2' FLG-302	933	FMG-302	882	FAG-302	837	55 lbs.	4
	30" FLG-300	1031	FMG-300	981	FAG-300	911	65 lbs.	5
	3' FLG-303	1099	FMG-303	1044	FAG-303	979	72 lbs.	6
	4' FLG-304	1137	FMG-304	1071	FAG-304	987	89 lbs.	8
	5' FLG-305	1250	FMG-305	1175	FAG-305	1074	107 lbs.	9
	6' FLG-306	1355	FMG-306	1267	FAG-306	1156	125 lbs.	11
	7' FLG-307	1791	FMG-307	1688	FAG-307	1423	148 lbs.	13
	8' FLG-308	1948	FMG-308	1831	FAG-308	1635	166 lbs.	15
	9' FLG-309	2416	FMG-309	2268	FAG-309	2055	176 lbs.	17
	10' FLG-3010	2631	FMG-3010	2491	FAG-3010	2275	287 lbs.	32
	11' FLG-3011	2816	FMG-3011	2659	FAG-3011	2405	324 lbs.	35
	12' FLG-3012	2896	FMG-3012	2735	FAG-3012	2490	339 lbs.	37
<b>36" WIDE</b>	3' FLG-363	1275	FMG-363	1240	FAG-363	1166	88 lbs.	7
	4' FLG-364	1323	FMG-364	1288	FAG-364	1211	98 lbs.	9
	5' FLG-365	1471	FMG-365	1427	FAG-365	1349	118 lbs.	11
	6' FLG-366	1592	FMG-366	1544	FAG-366	1471	138 lbs.	13
	7' FLG-367	2119	FMG-367	2059	FAG-367	1987	164 lbs.	16
	8' FLG-368	2238	FMG-368	2180	FAG-368	2103	184 lbs.	18
	9' FLG-369	2898	FMG-369	2822	FAG-369	2576	190 lbs.	20
	10' FLG-3610	3116	FMG-3610	2948	FAG-3610	2792	223 lbs.	38
	11' FLG-3611	3377	FMG-3611	3247	FAG-3611	2955	350 lbs.	41
	12' FLG-3612	3456	FMG-3612	3330	FAG-3612	3035	365 lbs.	45

#### SIDE SPLASH



TA-30 1 1/2" Side Splash \$92 ea.  
TA-31 5" Side Splash 173 ea.  
TA-32 10 1/2" Side Splash 339 ea.

#### K.D. ALUMINUM PAN RACK SLIDES

6 Slides - 2" Spacing  
Mounted on Tables (min. length 3")

TA-44  
\$644

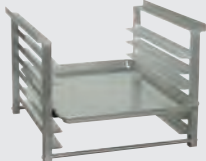

Glass Rack Slides  
3 Slides - 7 1/2" Spacing  
TA-45 \$588

#### WORKTABLE CASTERS

When Used with Galvanized Legs

TA-25G-4 \$394/set of 4  
TA-25G-6 590/set of 6

5" Swivels with rubber wheels  
Each set with 2 brakes. Legs maintain 35-1/2" working height

TA-25B \$193 For Brakes on all wheels for TA-25SG-4 or TA-25G-6

TA-25C X.H.D. Urethane wheels \$34 each caster

See Page 66 For More Casters



#### 3 TIER DRAWERS



Stainless Steel

TA-38  
\$3705

20" x 20" x 5"  
Drawer Inserts with Ball Bearing Slides

#### URN TROUGH

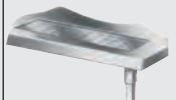

TA-64  
\$156/lin.ft.

# TABLES

1-1/2" Rear Splash  
W/ Open Base

Stainless Steel TOP  
Stainless Steel LEGS



Take Our Tables To  
New Heights!

### ADJUSTABLE TABLE HEIGHT UPGRADE

(Up to 6' tables only. Ships set up.)

- Add To Any Tubular Leg Style Table with Underself
- Adjust Table Height From 31 1/2" - 40 1/2"
- Easy Turning, Non-Obstructive Fold Away Handle

TA-900  
\$4653 ea.

Up to 40 1/2"  
Max. Ht.  
From Floor

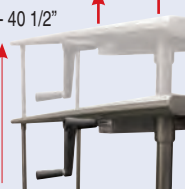

TFSS, TFMS, TSFG Series  
Bullnose Edge

## Premium

## Standard

## Super Saver

14 Ga. 304 S/S

16 Ga. 304 S/S

16 Ga. 430 S/S

Length	Premium			Standard			Super Saver			Approx. Shipping Weight	Approx. Cubic Feet
	Model #	Price	Model #	Price	Model #	Price	Model #	Price			
<b>24" WIDE</b>	2'	TFSS-242	\$1366	TFMS-242	\$1284	TSFG-242	\$1267	25 lbs.	3		
	30"	TFSS-240	1492	TFMS-240	1389	TSFG-240	1342	42 lbs.	4		
	3'	TFSS-243	1560	TFMS-243	1455	TSFG-243	1409	53 lbs.	5		
	4'	TFSS-244	1615	TFMS-244	1502	TSFG-244	1434	64 lbs.	6		
	5'	TFSS-245	1740	TFMS-245	1608	TSFG-245	1533	74 lbs.	8		
	6'	TFSS-246	1870	TFMS-246	1721	TSFG-246	1633	85 lbs.	9		
	7'	TFSS-247	2472	TFMS-247	2287	TSFG-247	1966	103 lbs.	11		
	8'	TFSS-248	2638	TFMS-248	2434	TSFG-248	2092	114 lbs.	12		
	9'	TFSS-249	3340	TFMS-249	3059	TSFG-249	2898	130 lbs.	14		
	10'	TFSS-2410	3561	TFMS-2410	3270	TSFG-2410	3116	227 lbs.	26		
	11'	TFSS-2411	3795	TFMS-2411	3477	TSFG-2411	3291	251 lbs.	29		
	12'	TFSS-2412	3875	TFMS-2412	3557	TSFG-2412	3353	266 lbs.	32		
<b>30" WIDE</b>	2'	TFSS-302	1419	TFMS-302	1329	TSFG-302	1290	47 lbs.	4		
	30"	TFSS-300	1523	TFMS-300	1462	TSFG-300	1405	52 lbs.	5		
	3'	TFSS-303	1633	TFMS-303	1530	TSFG-303	1468	59 lbs.	6		
	4'	TFSS-304	1719	TFMS-304	1593	TSFG-304	1517	72 lbs.	8		
	5'	TFSS-305	1874	TFMS-305	1731	TSFG-305	1638	85 lbs.	9		
	6'	TFSS-306	2029	TFMS-306	1806	TSFG-306	1761	93 lbs.	11		
	7'	TFSS-307	2577	TFMS-307	2380	TSFG-307	2031	113 lbs.	13		
	8'	TFSS-308	2823	TFMS-308	2609	TSFG-308	2245	126 lbs.	15		
	9'	TFSS-309	3598	TFMS-309	3296	TSFG-309	3103	150 lbs.	17		
	10'	TFSS-3010	3809	TFMS-3010	3510	TSFG-3010	3319	242 lbs.	32		
	11'	TFSS-3011	4106	TFMS-3011	3760	TSFG-3011	3536	268 lbs.	35		
	12'	TFSS-3012	4188	TFMS-3012	3843	TSFG-3012	3616	283 lbs.	37		
<b>36" WIDE</b>	3'	TFSS-363	1885	TFMS-363	1789	TSFG-363	1671	70 lbs.	7		
	4'	TFSS-364	1931	TFMS-364	1838	TSFG-364	1712	77 lbs.	9		
	5'	TFSS-365	2107	TFMS-365	1994	TSFG-365	1876	91 lbs.	11		
	6'	TFSS-366	2284	TFMS-366	2157	TSFG-366	2037	103 lbs.	13		
	7'	TFSS-367	3014	TFMS-367	2856	TSFG-367	2732	122 lbs.	16		
	8'	TFSS-368	3222	TFMS-368	3045	TSFG-368	2923	135 lbs.	18		
	9'	TFSS-369	4234	TFMS-369	3970	TSFG-369	3752	160 lbs.	20		
	10'	TFSS-3610	4450	TFMS-3610	4192	TSFG-3610	3968	253 lbs.	38		
	11'	TFSS-3611	4794	TFMS-3611	4509	TSFG-3611	4242	282 lbs.	41		
	12'	TFSS-3612	4875	TFMS-3612	4590	TSFG-3612	4318	297 lbs.	45		

Units 8 ft. and larger furnished with 6 legs. SPECIAL LENGTHS: Select next largest size. Add **Model # TA-61 No Charge** (ex. SS-306 with TA-61 size to 66" long).

### SELECTED SPEC-LINE UPGRADES

TA-3	Stainless Steel Hat Channel & Gusset	\$54 /lin. ft.
TA-94	16 ga. S/S 304 Underself. (any size)	54 /lin. ft.
TA-95	16 ga. S/S 304 Legs	127 /table
TA-23	Legs Welded to Underself or Cross-Rails, Shipped Set Up & Crated.	401 /table
TA-23A	Table Legs Welded To Leg Gussets & Underself or Cross-Bracing, Shipped Set Up & Crated.	506 /table

### WORKTABLE CASTERS

Maintains the 35-1/2" Working Height

TA-25	Castors for Open Base Tables (2 w/ Brakes)	\$394 /set of 4
TA-25A	Castors for Open Base Tables (2 w/ Brakes)	590 /set of 6
TA-25B	Set of Castors with Brakes on All	193 /set (Add to Above)
TA-25C	Upgrade Caster w/ Heavy Duty Urethane Wheels	34 ea. (Add to Above)

See Page 66 for More Caster Options



TFLG, TFMG, TFAG Series  
Bullnose Edge



# TABLES

1-1/2" Rear Splash  
W/ Open Base

Stainless Steel TOP  
Galvanized LEGS

### Premium

### Standard

### Super Saver

14 Ga. 304 S/S

16 Ga. 304 S/S

16 Ga. 430 S/S

Approx.  
Shipping  
Weight

Approx.  
Cubic  
Feet

Length	Model #	Price	Model #	Price	Model #	Price	Approx. Shipping Weight	Approx. Cubic Feet
<b>24" WIDE</b>	2'	TFLG-242 \$1256	TFMG-242 \$1003	TFAG-242 \$947	25 lbs.	3		
	30"	TFLG-240 1128	TFMG-240 1071	TFAG-240 1013	42 lbs.	4		
	3'	TFLG-243 1193	TFMG-243 1133	TFAG-243 1080	53 lbs.	5		
	4'	TFLG-244 1213	TFMG-244 1150	TFAG-244 1096	64 lbs.	6		
	5'	TFLG-245 1298	TFMG-245 1229	TFAG-245 1146	74 lbs.	8		
	6'	TFLG-246 1393	TFMG-246 1318	TFAG-246 1213	85 lbs.	9		
	7'	TFLG-247 1827	TFMG-247 1791	TFAG-247 1485	103 lbs.	11		
	8'	TFLG-248 1939	TFMG-248 1901	TFAG-248 1663	114 lbs.	12		
	9'	TFLG-249 2373	TFMG-249 2247	TFAG-249 2157	130 lbs.	14		
	10'	TFLG-2410 2592	TFMG-2410 2460	TFAG-2410 2378	227 lbs.	26		
	11'	TFLG-2411 2747	TFMG-2411 2592	TFAG-2411 2473	251 lbs.	29		
	12'	TFLG-2412 2827	TFMG-2412 2668	TFAG-2412 2531	266 lbs.	32		
<b>30" WIDE</b>	2'	TFLG-302 1050	TFMG-302 1006	TFAG-302 962	47 lbs.	4		
	30"	TFLG-300 1156	TFMG-300 1104	TFAG-300 1034	52 lbs.	5		
	3'	TFLG-303 1219	TFMG-303 1169	TFAG-303 1103	59 lbs.	6		
	4'	TFLG-304 1261	TFMG-304 1192	TFAG-304 1113	72 lbs.	8		
	5'	TFLG-305 1371	TFMG-305 1293	TFAG-305 1202	85 lbs.	9		
	6'	TFLG-306 1482	TFMG-306 1393	TFAG-306 1284	93 lbs.	11		
	7'	TFLG-307 1913	TFMG-307 1812	TFAG-307 1545	113 lbs.	13		
	8'	TFLG-308 2069	TFMG-308 1954	TFAG-308 1760	126 lbs.	15		
	9'	TFLG-309 2543	TFMG-309 2403	TFAG-309 2192	150 lbs.	17		
	10'	TFLG-3010 2759	TFMG-3010 2623	TFAG-3010 2405	242 lbs.	32		
	11'	TFLG-3011 2948	TFMG-3011 2789	TFAG-3011 2542	268 lbs.	35		
	12'	TFLG-3012 3027	TFMG-3012 2864	TFAG-3012 2621	283 lbs.	37		
<b>36" WIDE</b>	3'	TFLG-363 1410	TFMG-363 1357	TFAG-363 1288	70 lbs.	7		
	4'	TFLG-364 1443	TFMG-364 1410	TFAG-364 1335	77 lbs.	9		
	5'	TFLG-365 1593	TFMG-365 1550	TFAG-365 1479	91 lbs.	11		
	6'	TFLG-366 1710	TFMG-366 1671	TFAG-366 1593	103 lbs.	13		
	7'	TFLG-367 2242	TFMG-367 2189	TFAG-367 2112	122 lbs.	16		
	8'	TFLG-368 2361	TFMG-368 2302	TFAG-368 2229	135 lbs.	18		
	9'	TFLG-369 3079	TFMG-369 2952	TFAG-369 2703	160 lbs.	20		
	10'	TFLG-3610 3245	TFMG-3610 3168	TFAG-3610 2922	253 lbs.	38		
	11'	TFLG-3611 3505	TFMG-3611 3379	TFAG-3611 3087	282 lbs.	41		
	12'	TFLG-3612 3581	TFMG-3612 3461	TFAG-3612 3164	297 lbs.	45		

## QUICK METRIC CONVERSION TABLE

### CONVERT FROM

- Inches
- Meters
- Meters
- Centimeters
- Millimeters
- Cubic Inches

### INTO

- Cubic Feet
- Inches
- Feet
- Inches
- Inches
- Gallons

### MULTIPLY BY

- L x W x H divided by 1728
- 39.37
- 3.28
- 0.3937
- 0.03937
- L x W x H Divided By 231

# TABLES

## 10" & 5" Rear Splash W/ Undershef

Stainless Steel TOP  
Stainless Steel UNDERSHELF  
Stainless Steel LEGS

**Take Our Tables To New Heights!**

**ADJUSTABLE TABLE HEIGHT UPGRADE**  
(Up to 6' tables only. Ships set up.)

- Add To Any Tubular Leg Style Table with Undershef
- Adjust Table Height From 31 1/2" - 40 1/2"
- Easy Turning, Non-Obstructive Fold Away Handle

**TA-900**  
**\$4653 ea.**

Up to 40 1/2" Max. Ht. From Floor



VKS Series  
10" Back Splash  
Countertop Edge

KSS, KMS, SKG Series  
5" Back Splash  
Bullnose Edge



**Spec-Line Premium Standard Super Saver**

14 Ga. 304 S/S      14 Ga. 304 S/S      16 Ga. 304 S/S      16 Ga. 430 S/S

Length	Model #	Price	Model #	Price	Model #	Price	Model #	Price	Approx. Shipping Weight	Approx. Cubic Feet
<b>24" WIDE</b>	2' VKS-242	\$2155	KSS-242	\$1474	KMS-242	\$1394	SKG-242	\$1325	50 lbs.	5
	30" VKS-240	2284	KSS-240	1602	KMS-240	1505	SKG-240	1487	55 lbs.	6
	3' VKS-243	2352	KSS-243	1672	KMS-243	1570	SKG-243	1551	66 lbs.	7
	4' VKS-244	2412	KSS-244	1738	KMS-244	1628	SKG-244	1589	81 lbs.	9
	5' VKS-245	2536	KSS-245	1871	KMS-245	1746	SKG-245	1683	95 lbs.	12
	6' VKS-246	2662	KSS-246	2008	KMS-246	1870	SKG-246	1785	113 lbs.	14
	7' VKS-247	3174	KSS-247	2577	KMS-247	2401	SKG-247	2112	135 lbs.	16
	8' VKS-248	3335	KSS-248	2743	KMS-248	2555	SKG-248	2242	150 lbs.	18
	9' VKS-249	3880	KSS-249	3493	KMS-249	3218	SKG-249	3059	165 lbs.	21
	10' VKS-2410	4100	KSS-2410	3712	KMS-2410	3437	SKG-2410	3270	268 lbs.	28
	11' VKS-2411	4406	KSS-2411	3968	KMS-2411	3661	SKG-2411	3452	301 lbs.	36
	12' VKS-2412	4488	KSS-2412	4051	KMS-2412	3740	SKG-2412	3528	316 lbs.	39
<b>30" WIDE</b>	2' VKS-302	2211	KSS-302	1523	KMS-302	1427	SKG-302	1434	56 lbs.	6
	30" VKS-300	2360	KSS-300	1686	KMS-300	1573	SKG-300	1550	70 lbs.	7
	3' VKS-303	2428	KSS-303	1749	KMS-303	1642	SKG-303	1618	77 lbs.	9
	4' VKS-304	2511	KSS-304	1840	KMS-304	1712	SKG-304	1671	92 lbs.	11
	5' VKS-305	2664	KSS-305	2003	KMS-305	1868	SKG-305	1789	111 lbs.	14
	6' VKS-306	2816	KSS-306	2169	KMS-306	2012	SKG-306	1901	129 lbs.	17
	7' VKS-307	3277	KSS-307	2673	KMS-307	2491	SKG-307	2092	153 lbs.	20
	8' VKS-308	3526	KSS-308	2940	KMS-308	2735	SKG-308	2394	171 lbs.	22
	9' VKS-309	4205	KSS-309	3752	KMS-309	3445	SKG-309	3256	289 lbs.	25
	10' VKS-3010	4424	KSS-3010	3968	KMS-3010	3671	SKG-3010	3473	294 lbs.	40
	11' VKS-3011	4710	KSS-3011	4276	KMS-3011	3945	SKG-3011	3693	331 lbs.	43
	12' VKS-3012	4791	KSS-3012	4353	KMS-3012	4024	SKG-3012	3771	346 lbs.	47
<b>36" WIDE</b>	3' VKS-363	2811	KSS-363	2117	KMS-363	1971	SKG-363	1813	92 lbs.	10
	4' VKS-364	2858	KSS-364	2163	KMS-364	2014	SKG-364	1865	101 lbs.	14
	5' VKS-365	3041	KSS-365	2439	KMS-365	2275	SKG-365	2027	121 lbs.	17
	6' VKS-366	3227	KSS-366	2620	KMS-366	2437	SKG-366	2189	142 lbs.	20
	7' VKS-367	3840	KSS-367	3123	KMS-367	2902	SKG-367	2873	169 lbs.	23
	8' VKS-368	4048	KSS-368	3343	KMS-368	3106	SKG-368	3070	189 lbs.	27
	9' VKS-369	4847	KSS-369	4471	KMS-369	4116	SKG-369	3912	260 lbs.	30
	10' VKS-3610	5068	KSS-3610	4687	KMS-3610	4333	SKG-3610	4129	315 lbs.	46
	11' VKS-3611	5411	KSS-3611	5046	KMS-3611	4658	SKG-3611	4397	358 lbs.	51
	12' VKS-3612	5493	KSS-3612	5129	KMS-3612	4738	SKG-3612	4479	373 lbs.	55

Units 8 ft. and larger furnished with 6 leg **SPECIAL LENGTHS:** Select next largest size. Add **Model # TA-61 No Charge** (ex. SS-306 with TA-61 size to 66" long).

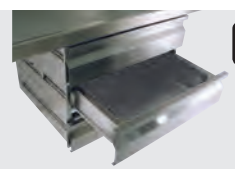

**PATENT PENDING**



### Revolutionary SHD Series Drawer with Integral Drawer Slides

- Stainless Steel Front & Sides
- Self Closing Drawer with Noise Control
- Drawer "Safety Stop" Tab
- Removable Stainless Steel Insert
- Units can be Stacked to Create Tier Drawers

Model #	Insert Size	Price
SHD-2015	20" x 15" x 5"	\$984
SHD-1520	15" x 20" x 5"	984
SHD-2020	20" x 20" x 5"	1051

### DELUXE SERIES

- Stainless Steel Front
- Ball Bearing Slides
- Removable Insert



Stainless Steel			Galvanized		
Model #	Insert Size	Price	Model #	Insert Size	Price
SS-2015	20" x 15" x 5"	\$539	GZ-2015	20" x 15" x 5"	\$383
SS-1520	15" x 20" x 5"	539	GZ-1520	15" x 20" x 5"	383
SS-2020	20" x 20" x 5"	584	GZ-2020	20" x 20" x 5"	418

See Pages 64-65 For More Drawer Details and More Drawer Options!



Featuring as Standard: "THE PROVEN"  
Original ADVANCE TABCO Adjustable Undershef  
with Die Cast Leg Clamp



# TABLES

## 10" & 5" Rear Splash W/ Undershef



VKG Series  
10" Back Splash  
Countertop Edge



KLG, KMG, KAG Series  
5" Back Splash  
Bullnose Edge

Stainless Steel TOP  
Galvanized UNDERSHELF  
Galvanized LEGS  
**Super Saver**

**Spec-Line**

**Premium**

**Standard**

**Super Saver**

Length	14 Ga. 304 S/S			14 Ga. 304 S/S			16 Ga. 304 S/S			16 Ga. 430 S/S		
	Model #	Price	Model #	Price	Model #	Price	Model #	Price	Model #	Price	Approx. Shipping Weight	Approx. Cubic Feet
<b>24" WIDE</b>	2'	VKG-242	\$1888	KLG-242	\$1089	KMG-242	\$1063	KAG-242	\$1006		50 lbs.	5
	30"	VKG-240	1987	KLG-240	1182	KMG-240	1147	KAG-240	1074		55 lbs.	6
	3'	VKG-243	2054	KLG-243	1246	KMG-243	1213	KAG-243	1137		66 lbs.	7
	4'	VKG-244	2086	KLG-244	1282	KMG-244	1241	KAG-244	1142		81 lbs.	9
	5'	VKG-245	2190	KLG-245	1371	KMG-245	1329	KAG-245	1219		95 lbs.	12
	6'	VKG-246	2290	KLG-246	1471	KMG-246	1421	KAG-246	1292		113 lbs.	14
	7'	VKG-247	2699	KLG-247	1871	KMG-247	1812	KAG-247	1589		135 lbs.	16
	8'	VKG-248	2828	KLG-248	1994	KMG-248	1953	KAG-248	1769		150 lbs.	18
	9'	VKG-249	3245	KLG-249	2472	KMG-249	2372	KAG-249	2267		165 lbs.	21
	10'	VKG-2410	3463	KLG-2410	2680	KMG-2410	2591	KAG-2410	2490		268 lbs.	28
	11'	VKG-2411	3720	KLG-2411	2783	KMG-2411	2743	KAG-2411	2645		301 lbs.	36
	12'	VKG-2412	3795	KLG-2412	2896	KMG-2412	2820	KAG-2412	2721		316 lbs.	39
<b>30" WIDE</b>	2'	VKG-302	1906	KLG-302	1105	KMG-302	1074	KAG-302	1013		56 lbs.	6
	30"	VKG-300	2019	KLG-300	1215	KMG-300	1182	KAG-300	1096		70 lbs.	7
	3'	VKG-303	2008	KLG-303	1285	KMG-303	1246	KAG-303	1161		77 lbs.	9
	4'	VKG-304	2141	KLG-304	1328	KMG-304	1288	KAG-304	1181		92 lbs.	11
	5'	VKG-305	2265	KLG-305	1441	KMG-305	1393	KAG-305	1264		111 lbs.	14
	6'	VKG-306	2386	KLG-306	1560	KMG-306	1506	KAG-306	1347		129 lbs.	17
	7'	VKG-307	2799	KLG-307	1957	KMG-307	1895	KAG-307	1660		153 lbs.	20
	8'	VKG-308	2977	KLG-308	2123	KMG-308	2051	KAG-308	1876		171 lbs.	22
	9'	VKG-309	3508	KLG-309	2636	KMG-309	2531	KAG-309	2428		195 lbs.	25
	10'	VKG-3010	3725	KLG-3010	2852	KMG-3010	2747	KAG-3010	2645		294 lbs.	40
	11'	VKG-3011	3945	KLG-3011	3054	KMG-3011	2932	KAG-3011	2827		331 lbs.	43
	12'	VKG-3012	4024	KLG-3012	3133	KMG-3012	3014	KAG-3012	2901		346 lbs.	47
<b>36" WIDE</b>	3'	VKG-363	2439	KLG-363	1622	KMG-363	1565	KAG-363	1486		92 lbs.	10
	4'	VKG-364	2494	KLG-364	1671	KMG-364	1600	KAG-364	1536		101 lbs.	14
	5'	VKG-365	2651	KLG-365	1834	KMG-365	1775	KAG-365	1666		121 lbs.	17
	6'	VKG-366	2798	KLG-366	1966	KMG-366	1896	KAG-366	1765		142 lbs.	20
	7'	VKG-367	3291	KLG-367	2302	KMG-367	2220	KAG-367	2086		169 lbs.	23
	8'	VKG-368	3425	KLG-368	2584	KMG-368	2499	KAG-368	2350		189 lbs.	27
	9'	VKG-369	4073	KLG-369	3188	KMG-369	3063	KAG-369	2962		260 lbs.	30
	10'	VKG-3610	4288	KLG-3610	3406	KMG-3610	3279	KAG-3610	3182		315 lbs.	46
	11'	VKG-3611	4550	KLG-3611	3639	KMG-3611	3500	KAG-3611	3386		358 lbs.	51
	12'	VKG-3612	4627	KLG-3612	3720	KMG-3612	3578	KAG-3612	3464		373 lbs.	55

### SIDE SPLASH

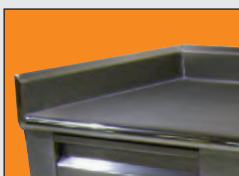

TA-30 1 1/2" Side Splash \$92 ea.  
TA-31 5" Side Splash 173 ea.  
TA-32 10 1/2" Side Splash 339 ea.

### K.D. ALUMINUM PAN RACK SLIDES

6 Slides - 2" Spacing  
Mounted on Tables (min. length 3")

TA-44  
\$644

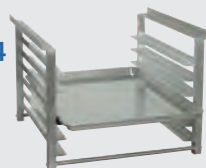

Glass Rack Slides  
3 Slides - 7 1/2" Spacing  
TA-45 \$588

### WORKTABLE CASTERS

When Used with Galvanized Legs

TA-25G-4 \$394/set of 4  
TA-25G-6 590/set of 6

5" Swivels with rubber wheels  
Each set with 2 brakes. Legs  
maintain 35-1/2" working height

TA-25B \$193 For Brakes on all  
wheels for TA-25SG-4 or TA-25G-6

TA-25C X.H.D. Urethane wheels  
\$34 each caster

See Page 66 For More Casters



### 3 TIER DRAWERS



Stainless  
Steel

TA-38  
\$3705

20" x 20" x 5"  
Drawer Inserts with  
Ball Bearing Slides

### URN TROUGH

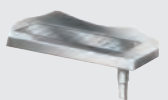

TA-64  
\$156/lin.ft.

See pages 59-66 for Additional Accessories & Modifications

# TABLES

## 10" & 5" Rear Splash W/ Open Base

Stainless Steel TOP  
Stainless Steel LEGS



**Take Our Tables To  
New Heights!**

**ADJUSTABLE TABLE HEIGHT UPGRADE**  
(Up to 6' tables only. Ships set up.)

- Add To Any Tubular Leg Style Table with Undershelf
- Adjust Table Height From 31 1/2" - 40 1/2"
- Easy Turning, Non-Obstructive Fold Away Handle

**TA-900**  
**\$4653 ea.**

Up to 40 1/2" Max. Ht. From Floor

TVKS Series  
10" Back Splash  
Countertop Edge



TKSS, TKMS,  
TSKG Series  
5" Back Splash  
Bullnose Edge

### Spec-Line

### Premium

### Standard

### Super Saver

14 Ga. 304 S/S      14 Ga. 304 S/S      16 Ga. 304 S/S      16 Ga. 430 S/S

Length	Model #	Price	Model #	Price	Model #	Price	Model #	Price	Approx. Shipping Weight	Approx. Cubic Feet	
<b>24" WIDE</b>	2'	TVKS-242	\$2283	TKSS-242	\$1595	TKMS-242	\$1517	TSKG-242	\$1517	43 lbs.	5
	30"	TVKS-240	2406	TKSS-240	1728	TKMS-240	1629	TSKG-240	1611	49 lbs.	6
	3'	TVKS-243	2474	TKSS-243	1794	TKMS-243	1692	TSKG-243	1677	55 lbs.	7
	4'	TVKS-244	2534	TKSS-244	1864	TKMS-244	1746	TSKG-244	1708	67 lbs.	9
	5'	TVKS-245	2661	TKSS-245	1993	TKMS-245	1870	TSKG-245	1805	77 lbs.	12
	6'	TVKS-246	2788	TKSS-246	2132	TKMS-246	1991	TSKG-246	1906	89 lbs.	14
	7'	TVKS-247	3298	TKSS-247	2696	TKMS-247	2519	TSKG-247	2231	107 lbs.	16
	8'	TVKS-248	3459	TKSS-248	2867	TKMS-248	2676	TSKG-248	2363	119 lbs.	18
	9'	TVKS-249	4008	TKSS-249	3621	TKMS-249	3345	TSKG-249	3188	135 lbs.	21
	10'	TVKS-2410	4228	TKSS-2410	3843	TKMS-2410	3566	TSKG-2410	3406	234 lbs.	28
	11'	TVKS-2411	4543	TKSS-2411	4101	TKMS-2411	3794	TSKG-2411	3578	258 lbs.	36
	12'	TVKS-2412	4617	TKSS-2412	4180	TKMS-2412	3871	TSKG-2412	3656	273 lbs.	39
<b>30" WIDE</b>	2'	TVKS-302	2339	TKSS-302	1646	TKMS-302	1562	TSKG-302	1562	48 lbs.	6
	30"	TVKS-300	2489	TKSS-300	1806	TKMS-300	1698	TSKG-300	1676	55 lbs.	7
	3'	TVKS-303	2553	TKSS-303	1873	TKMS-303	1765	TSKG-303	1738	62 lbs.	9
	4'	TVKS-304	2637	TKSS-304	1975	TKMS-304	1839	TSKG-304	1791	75 lbs.	11
	5'	TVKS-305	2791	TKSS-305	2130	TKMS-305	1990	TSKG-305	1912	89 lbs.	14
	6'	TVKS-306	2944	TKSS-306	2290	TKMS-306	2137	TSKG-306	2031	97 lbs.	17
	7'	TVKS-307	3403	TKSS-307	2798	TKMS-307	2609	TSKG-307	2302	118 lbs.	20
	8'	TVKS-308	3649	TKSS-308	3061	TKMS-308	2856	TSKG-308	2516	131 lbs.	22
	9'	TVKS-309	4342	TKSS-309	3882	TKMS-309	3582	TSKG-309	3389	150 lbs.	25
	10'	TVKS-3010	4553	TKSS-3010	4101	TKMS-3010	3796	TSKG-3010	3612	249 lbs.	40
	11'	TVKS-3011	4843	TKSS-3011	4408	TKMS-3011	4074	TSKG-3011	3823	276 lbs.	43
	12'	TVKS-3012	4922	TKSS-3012	4489	TKMS-3012	4155	TSKG-3012	3901	291 lbs.	47
<b>36" WIDE</b>	3'	TVKS-363	2934	TKSS-363	2238	TKMS-363	2091	TSKG-363	1937	80 lbs.	10
	4'	TVKS-364	2980	TKSS-364	2287	TKMS-364	2141	TSKG-364	1987	85 lbs.	14
	5'	TVKS-365	3162	TKSS-365	2569	TKMS-365	2396	TSKG-365	2148	99 lbs.	17
	6'	TVKS-366	3347	TKSS-366	2745	TKMS-366	2567	TSKG-366	2304	112 lbs.	20
	7'	TVKS-367	3963	TKSS-367	3249	TKMS-367	3028	TSKG-367	2994	131 lbs.	23
	8'	TVKS-368	4173	TKSS-368	3468	TKMS-368	3232	TSKG-368	3196	145 lbs.	27
	9'	TVKS-369	4978	TKSS-369	4597	TKMS-369	4247	TSKG-369	4037	165 lbs.	30
	10'	TVKS-3610	5201	TKSS-3610	4813	TKMS-3610	4466	TSKG-3610	4256	268 lbs.	46
	11'	TVKS-3611	5544	TKSS-3611	5180	TKMS-3611	4792	TSKG-3611	4528	298 lbs.	51
	12'	TVKS-3612	5620	TKSS-3612	5254	TKMS-3612	4870	TSKG-3612	4608	313 lbs.	55

Units 8 ft. and larger furnished with 6 legs. **SPECIAL LENGTHS:** Select next largest size. Add **Model # TA-61 No Charge** (ex. SS-306 with TA-61 size to 66" long).

### SELECTED SPEC-LINE UPGRADES

<b>TA-3</b>	Stainless Steel Hat Channel & Gusset	\$54 /lin. ft.
<b>TA-94</b>	16 ga. S/S 304 Undershelf. (any size)	54 /lin. ft.
<b>TA-95</b>	16 ga. S/S 304 Legs	127 /table
<b>TA-23</b>	Legs Welded to Undershelf or Cross-Rails, Shipped Set Up & Crated.	401 /table
<b>TA-23A</b>	Table Legs Welded To Leg Gussets & Undershelf or Cross-Bracing, Shipped Set Up & Crated.	506 /table

### WORKTABLE CASTERS

Maintains the 35-1/2" Working Height

<b>TA-25</b>	Castors for Open Base Tables (2 w/ Brakes)	\$394 /set of 4
<b>TA-25A</b>	Castors for Open Base Tables (2 w/ Brakes)	590 /set of 6
<b>TA-25B</b>	Set of Castors with Brakes on All	193 /set (Add to Above)
<b>TA-25C</b>	Upgrade Caster w/ Heavy Duty Urethane Wheels	34 ea. (Add to Above)

See Page 66 for More Caster Options



# TABLES

## 10" & 5" Rear Splash W/ Open Base



TVKG Series  
10" Back Splash  
Countertop Edge



TKLG, TKMG, TKAG Series  
5" Back Splash  
Bullnose Edge



Stainless Steel TOP  
Galvanized LEGS

	Spec-Line			Premium		Standard		Super Saver		Approx. Shipping Weight	Approx. Cubic Feet
	Length	Model #	Price	Model #	Price	Model #	Price	Model #	Price		
<b>24" WIDE</b>	2'	TVKG-242	\$2009	TKLG-242	\$1211	TKMG-242	\$1183	TKAG-242	\$1130	43 lbs.	5
	30"	TVKG-240	2112	TKLG-240	1300	TKMG-240	1275	TKAG-240	1202	49 lbs.	6
	3'	TVKG-243	2178	TKLG-243	1370	TKMG-243	1339	TKAG-243	1262	55 lbs.	7
	4'	TVKG-244	2210	TKLG-244	1404	TKMG-244	1363	TKAG-244	1293	67 lbs.	9
	5'	TVKG-245	2305	TKLG-245	1493	TKMG-245	1451	TKAG-245	1345	77 lbs.	12
	6'	TVKG-246	2416	TKLG-246	1593	TKMG-246	1544	TKAG-246	1418	89 lbs.	14
	7'	TVKG-247	2820	TKLG-247	1993	TKMG-247	1932	TKAG-247	1708	107 lbs.	16
	8'	TVKG-248	2956	TKLG-248	2122	TKMG-248	2055	TKAG-248	1895	119 lbs.	18
	9'	TVKG-249	3379	TKLG-249	2598	TKMG-249	2505	TKAG-249	2402	135 lbs.	21
	10'	TVKG-2410	3591	TKLG-2410	2813	TKMG-2410	2721	TKAG-2410	2621	234 lbs.	28
	11'	TVKG-2411	3847	TKLG-2411	2979	TKMG-2411	2876	TKAG-2411	2775	258 lbs.	36
	12'	TVKG-2412	3925	TKLG-2412	3058	TKMG-2412	2954	TKAG-2412	2852	273 lbs.	39
<b>30" WIDE</b>	2'	TVKG-302	2028	TKLG-302	1225	TKMG-302	1202	TKAG-302	1136	48 lbs.	6
	30"	TVKG-300	2143	TKLG-300	1339	TKMG-300	1300	TKAG-300	1216	55 lbs.	7
	3'	TVKG-303	2210	TKLG-303	1407	TKMG-303	1370	TKAG-303	1287	62 lbs.	9
	4'	TVKG-304	2264	TKLG-304	1450	TKMG-304	1410	TKAG-304	1298	75 lbs.	11
	5'	TVKG-305	2386	TKLG-305	1565	TKMG-305	1516	TKAG-305	1390	89 lbs.	14
	6'	TVKG-306	2512	TKLG-306	1683	TKMG-306	1630	TKAG-306	1475	97 lbs.	17
	7'	TVKG-307	2923	TKLG-307	2083	TKMG-307	2014	TKAG-307	1786	118 lbs.	20
	8'	TVKG-308	3102	TKLG-308	2245	TKMG-308	2177	TKAG-308	2000	131 lbs.	22
	9'	TVKG-309	3642	TKLG-309	2764	TKMG-309	2665	TKAG-309	2560	150 lbs.	25
	10'	TVKG-3010	3856	TKLG-3010	2980	TKMG-3010	2881	TKAG-3010	2775	249 lbs.	40
	11'	TVKG-3011	4074	TKLG-3011	3185	TKMG-3011	3064	TKAG-3011	2955	276 lbs.	43
	12'	TVKG-3012	4155	TKLG-3012	3262	TKMG-3012	3145	TKAG-3012	3035	291 lbs.	47
<b>36" WIDE</b>	3'	TVKG-363	2569	TKLG-363	1673	TKMG-363	1628	TKAG-363	1612	80 lbs.	10
	4'	TVKG-364	2610	TKLG-364	1721	TKMG-364	1673	TKAG-364	1660	85 lbs.	14
	5'	TVKG-365	2771	TKLG-365	1955	TKMG-365	1897	TKAG-365	1789	99 lbs.	17
	6'	TVKG-366	2922	TKLG-366	2086	TKMG-366	2016	TKAG-366	1889	112 lbs.	20
	7'	TVKG-367	3413	TKLG-367	2428	TKMG-367	2351	TKAG-367	2210	131 lbs.	23
	8'	TVKG-368	3549	TKLG-368	2708	TKMG-368	2620	TKAG-368	2463	145 lbs.	27
	9'	TVKG-369	4200	TKLG-369	3321	TKMG-369	3194	TKAG-369	3096	165 lbs.	30
	10'	TVKG-3610	4416	TKLG-3610	3536	TKMG-3610	3413	TKAG-3610	3308	268 lbs.	46
	11'	TVKG-3611	4678	TKLG-3611	3771	TKMG-3611	3631	TKAG-3611	3520	298 lbs.	51
	12'	TVKG-3612	4754	TKLG-3612	3847	TKMG-3612	3707	TKAG-3612	3592	313 lbs.	55

### Put a Sink in Your Table!

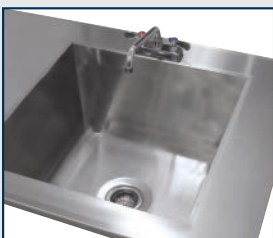

**SINGLE & DOUBLE BOWLS AVAILABLE**

For Integral Sinks - See Page 63

### POLY-VANCE 5/8" THICK CUTTING BOARDS

Model #	Description	Price
K-2A	Cutting Board For 10"x14" Bowls	\$281 ea.
K-2B	Cutting Board For 14"x16" Bowls	281 ea.
K-2C	Cutting Board For 16"x20" Bowls	281 ea.
K-2D	Cutting Board For 18"x24" Bowls	281 ea.
K-2E	Cutting Board For 20"x20" Bowls	281 ea.
K-2F	Cutting Board For 24"x24" Bowls	281 ea.
K-2J	Cutting Board For 18"x18" Bowls	281 ea.
K-2K	Cutting Board For 30"x24" Bowls	281 ea.

For Faucets & Accessories - See Page 33-34

# TABLES

## Enclosed Base Tables

### FLAT TOP UNITS



Open Base



**Heavy Duty Bolt-On Style Legs**  
On All Enclosed Base Tables!



Sliding Doors



Hinged Doors



\*Please add "M" after model number when adding Fixed Mid Shelf & refer to prices below

Length	Model #	w/ Fixed Mid-Shelf (Add "M")		Model #	# of Doors	w/ Fixed Mid-Shelf (Add "M")		Model #	# of Doors	w/ Fixed Mid-Shelf (Add "M")		Approx. Cubic Feet	
24" WIDE	3'	EB-SS-243	\$2716 M	\$3243	NOT AVAILABLE			HB-SS-243	2	\$4286 M	\$4814	30	
	4'	EB-SS-244	2818 M	3341	CB-SS-244	2	\$3878 M	\$4404	HB-SS-244	2	4492 M	5015	38
	5'	EB-SS-245	3017 M	3603	CB-SS-245	2	4167 M	4757	HB-SS-245	2	4789 M	5375	47
	6'	EB-SS-246	3216 M	3878	CB-SS-246	2	4468 M	5131	HB-SS-246	4	5080 M	5741	56
	7'	EB-SS-247	3501 M	4237	CB-SS-247	4	5108 M	5846	HB-SS-247	4	5717 M	6456	66
	8'	EB-SS-248	3679 M	4472	CB-SS-248	4	5519 M	6317	HB-SS-248	4	6135 M	6930	74
	9'	EB-SS-249	4169 M	5094	CB-SS-249	4	6186 M	7113	HB-SS-249	4	6803 M	7730	83
	10'	EB-SS-2410	4360 M	5283	CB-SS-2410	4	6379 M	7299	HB-SS-2410	4	6991 M	7916	92
12'	EB-SS-2412	6024 M	6759	CB-SS-2412	4	7809 M	8884	HB-SS-2412	6	9445 M	10618	109	
30" WIDE	3'	EB-SS-303	2864 M	3464	NOT AVAILABLE			HB-SS-303	2	4435 M	4980	35	
	4'	EB-SS-304	2966 M	3568	CB-SS-304	2	4025 M	4625	HB-SS-304	2	4633 M	5235	45
	5'	EB-SS-305	3189 M	3878	CB-SS-305	2	4343 M	5030	HB-SS-305	2	4963 M	5651	55
	6'	EB-SS-306	3417 M	4180	CB-SS-306	2	4666 M	5430	HB-SS-306	4	5284 M	6047	66
	7'	EB-SS-307	3650 M	4499	CB-SS-307	4	5249 M	6101	HB-SS-307	4	5865 M	6715	76
	8'	EB-SS-308	4031 M	4979	CB-SS-308	4	5748 M	6698	HB-SS-308	4	6362 M	7311	87
	9'	EB-SS-309	4445 M	5551	CB-SS-309	4	6458 M	7568	HB-SS-309	4	7077 M	8191	97
	10'	EB-SS-3010	4632 M	5740	CB-SS-3010	4	6647 M	7755	HB-SS-3010	4	7266 M	8381	107
12'	EB-SS-3012	6386 M	7118	CB-SS-3012	4	8642 M	9994	HB-SS-3012	6	9941 M	11111	128	
36" WIDE	3'	EB-SS-363	3069 M	3735	NOT AVAILABLE			HB-SS-363	2	4752 M	5414	41	
	4'	EB-SS-364	3168 M	3834	CB-SS-364	2	4293 M	4961	HB-SS-364	2	4954 M	5616	53
	5'	EB-SS-365	3407 M	4181	CB-SS-365	2	4636 M	5413	HB-SS-365	2	5298 M	6075	65
	6'	EB-SS-366	3808 M	4687	CB-SS-366	2	4983 M	5859	HB-SS-366	4	5644 M	6521	77
	7'	EB-SS-367	3896 M	4883	CB-SS-367	4	5608 M	6597	HB-SS-367	4	6264 M	7257	90
	8'	EB-SS-368	4306 M	5340	CB-SS-368	4	6144 M	7179	HB-SS-368	4	6795 M	7830	102
	9'	EB-SS-369	4761 M	6057	CB-SS-369	4	6913 M	8210	HB-SS-369	4	7574 M	8867	114
	10'	EB-SS-3610	4952 M	6249	CB-SS-3610	4	7099 M	8399	HB-SS-3610	4	7763 M	9059	126
12'	EB-SS-3612	6512 M	7666	CB-SS-3612	4	9167 M	10637	HB-SS-3612	6	10767 M	12071	151	

## 1-1/2" BACKSPASH UNITS

Open Base

Sliding Doors

Hinged Doors

Length	Model #	w/ Fixed Mid-Shelf (Add "M")		Model #	# of Doors	w/ Fixed Mid-Shelf (Add "M")		Model #	# of Doors	w/ Fixed Mid-Shelf (Add "M")		Approx. Cubic Feet	
24" WIDE	3'	EF-SS-243	\$2716 M	\$3243	NOT AVAILABLE			HF-SS-243	2	\$4286 M	\$4814	30	
	4'	EF-SS-244	2818 M	3341	CF-SS-244	2	\$3878 M	\$4404	HF-SS-244	2	4492 M	5015	38
	5'	EF-SS-245	3017 M	3603	CF-SS-245	2	4167 M	4757	HF-SS-245	2	4789 M	5375	47
	6'	EF-SS-246	3216 M	3878	CF-SS-246	2	4468 M	5131	HF-SS-246	4	5080 M	5741	56
	7'	EF-SS-247	3501 M	4237	CF-SS-247	4	5108 M	5846	HF-SS-247	4	5717 M	6456	66
	8'	EF-SS-248	3679 M	4472	CF-SS-248	4	5519 M	6317	HF-SS-248	4	6135 M	6930	74
	9'	EF-SS-249	4169 M	5094	CF-SS-249	4	6186 M	7113	HF-SS-249	4	6803 M	7730	83
	10'	EF-SS-2410	4360 M	5283	CF-SS-2410	4	6379 M	7299	HF-SS-2410	4	6991 M	7916	92
12'	EF-SS-2412	6024 M	6759	CF-SS-2412	4	7809 M	8884	HF-SS-2412	6	9445 M	10618	109	
30" WIDE	3'	EF-SS-303	2864 M	3464	NOT AVAILABLE			HF-SS-303	2	4435 M	5033	35	
	4'	EF-SS-304	2966 M	3568	CF-SS-304	2	4025 M	4625	HF-SS-304	2	4633 M	5235	45
	5'	EF-SS-305	3189 M	3878	CF-SS-305	2	4343 M	5030	HF-SS-305	2	4963 M	5651	55
	6'	EF-SS-306	3415 M	4180	CF-SS-306	2	4666 M	5430	HF-SS-306	4	5284 M	6047	66
	7'	EF-SS-307	3650 M	4499	CF-SS-307	4	5249 M	6101	HF-SS-307	4	5865 M	6715	76
	8'	EF-SS-308	4031 M	4979	CF-SS-308	4	5748 M	6698	HF-SS-308	4	6362 M	7311	87
	9'	EF-SS-309	4445 M	5551	CF-SS-309	4	6458 M	7568	HF-SS-309	4	7077 M	8185	97
	10'	EF-SS-3010	4632 M	5740	CF-SS-3010	4	6647 M	7755	HF-SS-3010	4	7266 M	8375	107
12'	EF-SS-3012	6386 M	7118	CF-SS-3012	4	8642 M	9994	HF-SS-3012	6	9941 M	11111	128	

(Approx. Shipping Weight Is 50 Lbs. Per Lineal Foot)

**Call For Installation of Buyout Equipment!**

FOR 36" WIDE 1-1/2" SPLASH UNITS: Use 36" Flat Top Price and Replace "B" with "F" (Example: EB-SS-364 would change to read EF-SS-364)

**\*Please add "M" after model number when adding Fixed Mid Shelf & refer to prices below**



# TABLES

## Enclosed Base Tables

5"  
BACKSPLASH  
UNITS



**Open Base**

**Sliding Doors**

**Hinged Doors**

Length	Model #	w/ Fixed Mid-Shelf (Add "M")		Model #	# of Doors	w/ Fixed Mid-Shelf (Add "M")		Model #	# of Doors	w/ Fixed Mid-Shelf (Add "M")		Approx. Cubic Feet
<b>24" WIDE</b>	3'	EK-SS-243	\$2802 M \$3274	NOT AVAILABLE			HK-SS-243	2	\$4376 M \$4904		30	
	4'	EK-SS-244	2904 M 3373	CK-SS-244	2	\$3962 M \$4492	HK-SS-244	2	4579 M 5104		38	
	5'	EK-SS-245	3108 M 3641	CK-SS-245	2	4263 M 4854	HK-SS-245	2	4875 M 5473		47	
	6'	EK-SS-246	3316 M 3922	CK-SS-246	2	4572 M 5277	HK-SS-246	4	5184 M 5850		56	
	7'	EK-SS-247	3610 M 4213	CK-SS-247	4	5213 M 5955	HK-SS-247	4	5829 M 6574		66	
	8'	EK-SS-248	3795 M 4529	CK-SS-248	4	5631 M 6427	HK-SS-248	4	6253 M 7048		74	
	9'	EK-SS-249	4303 M 5168	CK-SS-249	4	6319 M 7239	HK-SS-249	4	6932 M 7858		83	
	10'	EK-SS-2410	4494 M 5355	CK-SS-2410	4	6508 M 7431	HK-SS-2410	4	7122 M 8048		92	
	12'	EK-SS-2412	6170 M 7115	CK-SS-2412	4	8506 M 9535	HK-SS-2412	6	9630 M 10768		109	
	<b>30" WIDE</b>	3'	EK-SS-303	3044 M 3551	NOT AVAILABLE			HK-SS-303	2	4519 M 5122		35
4'		EK-SS-304	3150 M 3651	CK-SS-304	2	4109 M 4708	HK-SS-304	2	4725 M 5326		45	
5'		EK-SS-305	3312 M 4002	CK-SS-305	2	4439 M 5130	HK-SS-305	2	5053 M 5745		55	
6'		EK-SS-306	3459 M 4224	CK-SS-306	2	4768 M 5535	HK-SS-306	4	5382 M 6148		66	
7'		EK-SS-307	3755 M 4610	CK-SS-307	4	5359 M 6207	HK-SS-307	4	5979 M 7811		76	
8'		EK-SS-308	4148 M 5093	CK-SS-308	4	5862 M 6810	HK-SS-308	4	6863 M 7862		87	
9'		EK-SS-309	4573 M 5742	CK-SS-309	4	6591 M 7705	HK-SS-309	4	7208 M 8313		97	
10'		EK-SS-3010	4767 M 5865	CK-SS-3010	4	6783 M 7890	HK-SS-3010	4	7395 M 8655		107	
12'		EK-SS-3012	6510 M 7455	CK-SS-3012	4	9083 M 10293	HK-SS-3012	6	10418 M 11558		128	
<b>36" WIDE</b>		3'	EK-SS-363	3158 M 3818	NOT AVAILABLE			HK-SS-363	2	4838 M 5502		41
	4'	EK-SS-364	3259 M 3920	CK-SS-364	2	4384 M 5047	HK-SS-364	2	5043 M 5704		53	
	5'	EK-SS-365	3484 M 4331	CK-SS-365	2	4741 M 5511	HK-SS-365	2	5393 M 6167		65	
	6'	EK-SS-366	3902 M 4786	CK-SS-366	2	5089 M 5966	HK-SS-366	4	5746 M 6618		77	
	7'	EK-SS-367	4010 M 4992	CK-SS-367	4	5720 M 6710	HK-SS-367	4	6382 M 7367		90	
	8'	EK-SS-368	4425 M 5460	CK-SS-368	4	6260 M 7294	HK-SS-368	4	7329 M 8367		102	
	9'	EK-SS-369	5299 M 6135	CK-SS-369	4	7049 M 8345	HK-SS-369	4	7650 M 8943		114	
	10'	EK-SS-3610	5741 M 6322	CK-SS-3610	4	7179 M 8474	HK-SS-3610	4	7837 M 9130		126	
	12'	EK-SS-3612	6767 M 8015	CK-SS-3612	4	9737 M 10965	HK-SS-3612	6	11096 M 12299		151	

(approx. shipping weight is 75 lbs. per lineal foot)

For Enclosed Base Tables Over 12' Add The Following:

TA-65	Open Base Units	\$499 /lin. ft.
TA-66	Sliding Door Units	727 /lin. ft.
TA-67	Hinged Door Units	770 /lin. ft.

**We Recommend a Welded Field Joint For Units Over 12'**

**TA-57 \$257 ea.**

(Units over 14' require a Welded or Bolted Field Joint)

### ENCLOSED BASE MODIFICATIONS & ACCESSORIES

TA-255P	Four 5" Heavy Duty Bolt-On Casters .....	\$636 set/4
TA-255AP	Six 5" Heavy Duty Bolt-On Casters .....	928 set/6
TA-19L	Replacement Bolt-on Leg w/ Flanged Foot .....	76 ea.
TA-46	Door Lock .....	286 ea.
TA-54	Removable Kick Plate .....	155 /lin. ft.
TA-130	Cutlery Dispenser Holder .....	226 /lin. ft.
TA-135	Plate Shelf .....	270 /lin. ft.



**CASH-1 \$1078 ea.**  
Undermount Cash Drawer



**TA-20L \$66 ea.**  
Replacement Bolt-On Leg

### ADJUSTABLE MID SHELVES FOR ENCLOSED BASE TABLES

#### TA-116 ADJUSTABLE ENCLOSED BASE CABINET MID SHELF \$800 Per Section

Add To Price of Enclosed Base Table with Fixed Mid Shelf (M).

Shelves Over 36" In Length Require Multiple Sections With Center Partition.

For Partial Shelves Add to Price of Shelf on Page 66.

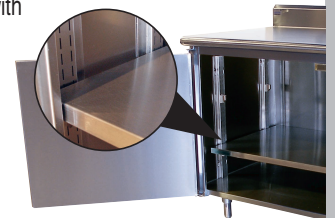

# TABLES

## Enclosed Base Tables



**30" Wide Units!**

Featuring SHD Series NSF Drawers



**Hinged Doors**



**Sliding Doors**

## ENCLOSED BASE TABLES WITH DRAWERS

Length	w/ Hinged Door		w/ Sliding Doors		# of Drawers	# of Doors	Weight	Cubic Feet
	Model #	Price	Model #	Price				
60"	<a href="#">HDRC-305</a>	<b>\$7299</b>	<a href="#">SDRC-305</a>	<b>\$7184</b>	2	2	300 lbs.	55
72"	<a href="#">HDRC-306</a>	<b>7787</b>	<a href="#">SDRC-306</a>	<b>7660</b>	2	4	360 lbs.	66
84"	<a href="#">HDRC-307</a>	<b>9361</b>	<a href="#">SDRC-307</a>	<b>9268</b>	3	4	420 lbs.	76
96"	<a href="#">HDRC-308</a>	<b>9533</b>	<a href="#">SDRC-308</a>	<b>9364</b>	3	4	540 lbs.	87
120"	<a href="#">HDRC-3010</a>	<b>12050</b>	<a href="#">SDRC-3010</a>	<b>11954</b>	4	4	600 lbs.	107

### ACCESSORIES

<a href="#">TA-105</a>	Modified to 24" Width	<b>\$306</b> /table	<a href="#">TA-14</a>	Drawer Lock	<b>\$128</b> ea.
<a href="#">TA-110</a>	Modified to 36" Width	<b>58</b> /lin. ft.	<a href="#">TA-46</a>	Door Lock	<b>286</b> ea.



Model #	Option	Price
<a href="#">TA-100F</a>	Bullnose Front Top Edge	<b>\$112</b>
<a href="#">TA-101</a>	Rear Tray Lock	<b>\$92</b> /lin. ft.
<a href="#">TA-61</a>	Special Sizing Charge (From Next Larger Size)	<b>N/C</b>

## DISH CABINETS

Length	15" WIDE				18" WIDE			
	Model #	Weight	Cu. Ft.	Price	Model #	Weight	Cu. Ft.	Price
48"	<a href="#">DC-154</a>	155 lbs.	21	<b>\$2823</b>	<a href="#">DC-184</a>	170 lbs.	25	<b>\$3014</b>
60"	<a href="#">DC-155</a>	195 lbs.	27	<b>3018</b>	<a href="#">DC-185</a>	205 lbs.	31	<b>3259</b>
72"	<a href="#">DC-156</a>	225 lbs.	32	<b>3356</b>	<a href="#">DC-186</a>	245 lbs.	36	<b>3991</b>
84"	<a href="#">DC-157</a>	265 lbs.	37	<b>3498</b>	<a href="#">DC-187</a>	275 lbs.	41	<b>4308</b>
96"	<a href="#">DC-158</a>	295 lbs.	42	<b>3757</b>	<a href="#">DC-188</a>	315 lbs.	46	<b>4633</b>
120"	<a href="#">DC-1510</a>	360 lbs.	52	<b>4612</b>	<a href="#">DC-1810</a>	385 lbs.	56	<b>5242</b>
144"	<a href="#">DC-1512</a>	400 lbs.	62	<b>4749</b>	<a href="#">DC-1812</a>	425 lbs.	66	<b>5383</b>

**30" Wide Units!**



[TA-56](#)  
5" NSF

Includes K-60  
Splash Mounted Faucet



Model [BEV-30-72L](#) Shown

## BEVERAGE TABLES

Length	Model #	Price	Weight	Cu. Ft.
4'	<a href="#">BEV-30-48LorR*</a>	<b>\$6313</b>	230 lbs.	37
5'	<a href="#">BEV-30-60LorR*</a>	<b>6703</b>	250 lbs.	45
6'	<a href="#">BEV-30-72LorR*</a>	<b>7126</b>	270 lbs.	54
7'	<a href="#">BEV-30-84LorR*</a>	<b>8159</b>	290 lbs.	63
8'	<a href="#">BEV-30-96LorR*</a>	<b>8675</b>	330 lbs.	71
9'	<a href="#">BEV-30-108LorR*</a>	<b>13027</b>	360 lbs.	76
10'	<a href="#">BEV-30-120LorR*</a>	<b>13074</b>	380 lbs.	88
12'	<a href="#">BEV-30-144LorR*</a>	<b>13237</b>	430 lbs.	96

**Specify Sink Left Or Right End:**

\*Please Designate Left Or Right Sink Location By Using L Or R After Model Number When Ordering.

**Sink Size 14" x 16" x 12"**

Customize Your Own Beverage Table  
with Additional Accessories on Pages 59-66

[TA-45](#) Optional Glass Rack Slide **\$588**

**Call For Installation of Buyout Equipment!**

# MULTI-STATIONS

## NSF Multi-Stations



= Ships Via UPS

### 14 GA., 304 STAINLESS STEEL SINKS W/STAINLESS STEEL LEGS & FLANGED FEET

8" Bowl Depth • 8 1/2" High Backsplash • 8" O.C. Faucet Holes on Manual Operated, Single Holes on Knee/Toe-Push or Electronic Operated  
 • Stainless Steel Flanged Feet • Wall Support Bracket • Side & Rear Cross-Bracing • 3 1/2" Basket Drain(s)



FS-FM-40 Shown



FS-FM-40-F Shown



FS-FM-40EF Shown



FS-FM-40KV Shown



FS-FM-40FV Shown



Toe-Push Valve

L	NO FAUCETS INCLUDED		MANUAL FAUCETS INCLUDED		ELECTRONIC OPERATED FAUCETS		KNEE OPERATED FAUCETS		TOE-PUSH OPERATED FAUCETS		# of Faucets	Wt.	Cu. Ft.
	Model #	Price	Model #	Price	Model #	Price	Model #	Price	Model #	Price			
40"	FS-FM-40 <sup>†</sup>	\$4507	FS-FM-40-F	\$5002	FS-FM-40EF	\$6837	FS-FM-40KV	\$5773	FS-FM-40FV	\$6088	2	72 lbs.	15
60"	FS-FM-60 <sup>†</sup>	5068	FS-FM-60-F	5812	FS-FM-60EF	8558	FS-FM-60KV	6766	FS-FM-60FV	6963	3	84 lbs.	18
80"	FS-FM-80 <sup>†</sup>	5780	FS-FM-80-F	6771	FS-FM-80EF	10433	FS-FM-80KV	8056	FS-FM-80FV	8306	4	120 lbs.	22
100"	FS-FM-100 <sup>†</sup>	6487	FS-FM-100-F	7726	FS-FM-100EF	12303	FS-FM-100KV	9394	FS-FM-100FV	9644	5	156 lbs.	30
120"	FS-FM-120 <sup>†</sup>	8171	FS-FM-120-F	9658	FS-FM-120EF	15150	FS-FM-120KV	11560	FS-FM-120FV	11960	6	198 lbs.	36

<sup>†</sup>Add K-472 For Faucet Hole Revision \$121

### 14 GA., 304 STAINLESS STEEL A.D.A. SINKS W/STAINLESS STEEL LEGS & FLANGED FEET

5" Bowl Depth • 8 1/2" High Backsplash • 8" O.C. Faucet Holes on Manual Operated or Single Holes on Electronic Faucet Operated  
 • Stainless Steel Flanged Feet • Wall Support Bracket • Rear Cross-Bracing • 3 1/2" Basket Drain(s)



L	NO FAUCETS INCLUDED		MANUAL FAUCETS INCLUDED		ELECTRONIC OPERATED FAUCETS		# of Faucets	Wt.	Cu. Ft.
	Model #	Price	Model #	Price	Model #	Price			
40"	FS-FM-40-ADA <sup>†</sup>	\$4507	FS-FM-40-ADA-F	\$5005	FS-FM-40EFADA	\$6622	2	72 lbs.	15
60"	FS-FM-60-ADA <sup>†</sup>	5068	FS-FM-60-ADA-F	5894	FS-FM-60EFADA	8318	3	84 lbs.	18
80"	FS-FM-80-ADA <sup>†</sup>	5780	FS-FM-80-ADA-F	6939	FS-FM-80EFADA	11074	4	120 lbs.	22
100"	FS-FM-100-ADA <sup>†</sup>	6487	FS-FM-100-ADA-F	7987	FS-FM-100EFADA	12029	5	156 lbs.	30
120"	FS-FM-120-ADA <sup>†</sup>	8171	FS-FM-120-ADA-F	10007	FS-FM-120EFADA	14856	6	198 lbs.	36

<sup>†</sup>Add K-472 For Faucet Hole Revision \$121



### 16 GA., 304 STAINLESS STEEL SINKS WITH STAINLESS STEEL LEGS & FLANGED FEET

8" Bowl Depth • 8 1/2" High Backsplash • 8" O.C. Faucet Holes on Manual Operated, Single Holes on Knee/Toe-Push or Electronic Operated  
 • Stainless Steel Flanged Feet • Wall Support Bracket • Side & Rear Cross-Bracing • 3 1/2" Basket Drain(s)



L	NO FAUCETS INCLUDED		MANUAL FAUCETS INCLUDED		ELECTRONIC OPERATED FAUCETS		KNEE OPERATED FAUCETS		TOE-PUSH OPERATED FAUCETS		# of Faucets	Wt.	Cu. Ft.
	Model #	Price	Model #	Price	Model #	Price	Model #	Price	Model #	Price			
40"	FC-FM-40 <sup>†</sup>	\$3953	FC-FM-40-F	\$4449	FC-FM-40EF	\$6279	FC-FM-40KV	\$5055	FC-FM-40FV	\$5215	2	66 lbs.	15
60"	FC-FM-60 <sup>†</sup>	4512	FC-FM-60-F	5255	FC-FM-60EF	8002	FC-FM-60KV	6076	FC-FM-60FV	6406	3	77 lbs.	18
80"	FC-FM-80 <sup>†</sup>	5300	FC-FM-80-F	6292	FC-FM-80EF	9953	FC-FM-80KV	7380	FC-FM-80FV	7827	4	110 lbs.	22
100"	FC-FM-100 <sup>†</sup>	6080	FC-FM-100-F	7319	FC-FM-100EF	11894	FC-FM-100KV	8572	FC-FM-100FV	9236	5	143 lbs.	30
120"	FC-FM-120 <sup>†</sup>	7315	FC-FM-120-F	8802	FC-FM-120EF	14294	FC-FM-120KV	10208	FC-FM-120FV	11104	6	182 lbs.	36

<sup>†</sup>Add K-472 For Faucet Hole Revision \$121

### 16 GA., 304 STAINLESS STEEL A.D.A. SINKS W/STAINLESS STEEL LEGS & FLANGED FEET

5" Bowl Depth • 8 1/2" High Backsplash • 8" O.C. Faucet Holes on Manual Operated or Single Holes on Electronic Faucet Operated  
 • Stainless Steel Flanged Feet • Wall Support Bracket • Rear Cross-Bracing • 3 1/2" Basket Drain(s)



L	NO FAUCETS INCLUDED		MANUAL FAUCETS INCLUDED		ELECTRONIC OPERATED FAUCETS		# of Faucets	Wt.	Cu. Ft.
	Model #	Price	Model #	Price	Model #	Price			
40"	FC-FM-40-ADA <sup>†</sup>	\$3954	FC-FM-40-ADA-F	\$4503	FC-FM-40EFADA	\$6120	2	66 lbs.	15
60"	FC-FM-60-ADA <sup>†</sup>	4512	FC-FM-60-ADA-F	5358	FC-FM-60EFADA	7783	3	77 lbs.	18
80"	FC-FM-80-ADA <sup>†</sup>	5300	FC-FM-80-ADA-F	6387	FC-FM-80EFADA	9620	4	110 lbs.	22
100"	FC-FM-100-ADA <sup>†</sup>	6080	FC-FM-100-ADA-F	7635	FC-FM-100EFADA	11676	5	143 lbs.	30
120"	FC-FM-120-ADA <sup>†</sup>	7315	FC-FM-120-ADA-F	9152	FC-FM-120EFADA	14001	6	182 lbs.	36

<sup>†</sup>Add K-472 For Faucet Hole Revision \$121



FC-FM-40-EFADA Shown

# WALL CABINETS

## 15" WIDE STAINLESS STEEL WALL CABINETS

18 Gauge, 430 Stainless Steel  
Includes Fixed Mid-Shelf

SLIDING  
DOOR



OPEN  
UNIT



HINGED  
DOORS



Size L x W x H	W/ SLIDING DOORS				OPEN UNIT			W/ HINGED DOORS				Approx. Cu. Ft.
	Model #	Price	Doors	Approx. Weight	Model #	Price	Approx. Weight	Model #	Price	Doors	Approx. Weight	
36" x 15" x 32-1/2"	NOT AVAILABLE				WCO-15-36	\$3397	95 lbs.	WCH-15-36	\$5007	2	120 lbs.	17
48" x 15" x 32-1/2"	WCS-15-48	\$5096	2	155 lbs.	WCO-15-48	3913	120 lbs.	WCH-15-48	5424	2	150 lbs.	21
60" x 15" x 32-1/2"	WCS-15-60	5891	2	185 lbs.	WCO-15-60	4272	145 lbs.	WCH-15-60	6210	2	180 lbs.	26
72" x 15" x 32-1/2"	WCS-15-72	6398	2	220 lbs.	WCO-15-72	5165	180 lbs.	WCH-15-72	6362	4	240 lbs.	31
96" x 15" x 32-1/2"	WCS-15-96	8040	4	295 lbs.	WCO-15-96	5538	240 lbs.	WCH-15-96	7194	4	320 lbs.	41

## STORAGE CABINETS



### 84" High Storage Cabinet w/ 4 Fixed Mid-Shelves

- Single Left-Hinged Door\*
- 4 Fixed Stainless Steel Mid-Shelves
- Enclosed Back Panel  
Ventilation Slots

Overall Size: 25"L x 22-5/8"W x 84"H

**CAB-4 \$5819**  
18 Gauge, 430 Stainless Steel

**CAB-4-300 \$6389**  
18 Gauge, 300 Stainless Steel



Vented  
Side Panels



### Wall Mounted Chemical Storage Cabinet w/ 1 Fixed Mid-Shelf

- Left-Hinged Door\*
- Vented Side Panels
- Mounting Hardware Not Included

Overall Size: 24"L x 15"W x 32-1/2"H

**WCH-15-24 \$4222**

18 Gauge, 430 Stainless Steel

**WCH-15-24-300 \$4678**

18 Gauge, 300 Stainless Steel

WCH-15-24 Left Hinged  
Shown (Standard)

\*Optional Right-Hand Door Swing Available - Add CAB-R N/C

## CABINET ACCESSORIES & MODIFICATIONS



Adjustable Mid-Shelf

**TA-115 \$132 per lin. ft.**  
Add to Price of 84" High Storage  
Cabinets or Wall Cabinets



Additional Fixed Mid-Shelf

**WC-SHELF \$86 per lin. ft.**    **K-94-SHELF \$355 ea.**  
For WCS, WCO, WCH Series    For 84" High Storage Cabinet  
Wall Cabinets

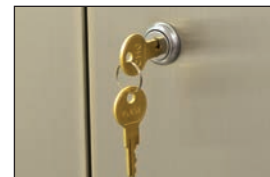

Cabinet Door Lock

**SU-27 \$286**  
One Per Hinged Door or  
Pair of Sliding Doors

# SPECIALTY TABLES

## Specialty Tables

### DEMO TABLE

Countertop Edge Mirror Tilts to Desired Position



Model #	Table Size	Mirror Size	Wt.	Cu.	Price
VSS-DT-365	36" x 60"	24" x 48"	275 lbs.	18	\$7673
VSS-DT-366	36" x 72"	24" x 60"	305 lbs.	23	9034

### CEILING MOUNTED DEMO MIRROR

- 16 ga. type 304 Stainless Steel
- 1 5/8" Tubing - 4' Posts
- 14 ga. Rainbow Uprights For Added Support
- Glass Mirror



Model #	Mirror Size	Wt.	Cu.	Price
MI-48	24" x 48"	91 lbs.	7	\$4312
MI-60	24" x 60"	115 lbs.	8	5060

Mirror Tilts to Desired Position

PRINT REQUIRED

### CORNER TABLES 14 Gauge, 304 Stainless Steel

5" Rear Splash (1" Return)

Length	24" WIDE		30" WIDE		Wt.	Cu. Ft.
	Model #	Price	Model #	Price		
5'	KTMS-245	\$6544	KTMS-305	\$6679	280 lbs.	30
6'	KTMS-246	6679	KTMS-306	6811	300 lbs.	35
7'	KTMS-247	6811	KTMS-307	6945	320 lbs.	40
8'	KTMS-248	6945	KTMS-308	7077	345 lbs.	45
9'	KTMS-249	7077	KTMS-309	7212	375 lbs.	50
10'	KTMS-2410	7212	KTMS-3010	7347	400 lbs.	55
11'	KTMS-2411	7347	KTMS-3011	7479	425 lbs.	60
12'	KTMS-2412	7613	KTMS-3012	7747	450 lbs.	65

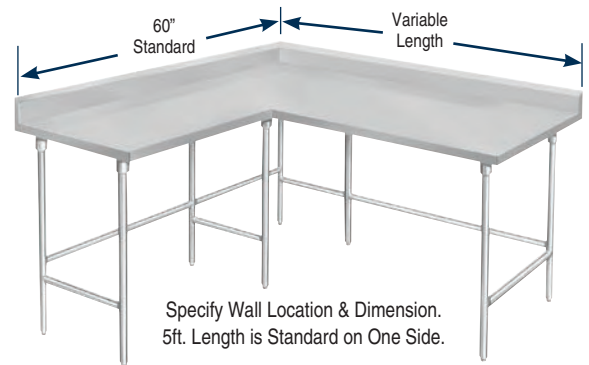

Specify Wall Location & Dimension. 5ft. Length is Standard on One Side.

(Length can be modified, but not to exceed 7 ft. on one wall dimension)

TA-57 \$257 Prepare Welded Field Joint

### Accessories

KT-100	36" Width On Corner Tables	\$137 /lin. ft.	KT-103	Stainless Steel Undershef	\$58 /lin. ft.
KT-101	Additional Length in Excess of 5'	162 /lin. ft.	KT-104	Stainless Steel Cabinet Base	349 /lin. ft.
KT-102	Special Sizing Charge	N/C		(Top Is Shipped Separately For Ease In Installation)	

### WORK TABLE WITH PREP SINK & FAUCET



- 16 ga., 304 Stainless Steel Top
- 5" Rear Splash
- 16" x 20" x 12" Sink Bowl
- Stainless Steel Adjustable Undershef
- 4 O.C. Deck Mounted Faucet & Basket Drain Included
- Stainless Steel Legs & Bullet Feet

Model #	Size	Price
KMS-11B-305L	30"x60"	\$3666
KMS-11B-305R	30"x60"	3666
KMS-11B-306L	30"x72"	3789
KMS-11B-306R	30"x72"	3789

CHOOSE LEFT OR RIGHT SINK POSITION

### PREP TABLE WITH COUNTERTOP EDGE



- 10" Rear Splash
- Includes 1 - 16" x 20" x 8" & 1 - 16" x 20" x 4" Integrally Welded Stainless Steel Sinks
- 21" x 18" x 5/8" Poly-Vance Cutting Board
- Stainless Steel Die-Formed Drawer
- Includes K-55 4" O.C. Gooseneck Faucet.

Model #	Size	Weight	Cu. Ft.	Price
DL-30-72	30" x 72"	155 lbs.	36	\$5872
DL-30-96	30" x 96"	198 lbs.	47	6551

See Page 63 For Additional Integral Sink Sizes

# MIXER TABLES

Mixer Tables



Ship Via UPS

## MIXER TABLE WITH UTENSIL RACK

24" Work Height to Top of Table (Utensil Rack Has Height of 78")

Size	Stainless Steel Base		Galvanized Base		Wt.	Cu. Ft.
24 x 24	MX-SS-242	\$1909	MX-GL-242	\$1655	53 lbs.	3
24 x 30	MX-SS-302	1976	MX-GL-302	1691	63 lbs.	4
30 x 30	MX-SS-300	2121	MX-GL-300	1808	70 lbs.	5
30 x 36	MX-SS-303	2150	MX-GL-303	1832	77 lbs.	6
36 x 36	MX-SS-363	2209	MX-GL-363	1891	81 lbs.	7

MX-SS-242  
Shown  
Mixer Not Included



## MIXER TABLE WITH UNDERSHELF

24" Work Height

Size	Stainless Steel Base		Galvanized Base		Wt.	Cu. Ft.
24 x 24	MT-SS-242	\$1143	MT-GL-242	\$940	45 lbs.	3
24 x 30	MT-SS-302	1201	MT-GL-302	981	50 lbs.	4
30 x 30	MT-SS-300	1361	MT-GL-300	1093	55 lbs.	5
30 x 36	MT-SS-303	1382	MT-GL-303	1124	68 lbs.	6
36 x 36	MT-SS-363	1449	MT-GL-363	1174	71 lbs.	7

MT-SS-242  
Shown



## BUDGET MIXER TABLES

24" Work Height

Size	Stainless Steel Base		Galvanized Base		Wt.	Cu. Ft.
24 x 24	SAG-MT-242	\$1033	AG-MT-242	\$839	38 lbs.	3
24 x 30	SAG-MT-302	1085	AG-MT-302	861	41 lbs.	4
30 x 30	SAG-MT-300	1108	AG-MT-300	879	52 lbs.	5
30 x 36	SAG-MT-303	1181	AG-MT-303	923	58 lbs.	6
36 x 36	SAG-MT-363	1247	AG-MT-363	986	64 lbs.	7

AG-MT-242  
Shown



## MOBILE MIXER TABLES WITH TRAY SLIDES & CASTERS

28" Work Height. Tray Slides Have 2" Spacing

Size	Stainless Steel Base		Galvanized Base		Wt.	Cu. Ft.
30 x 30	MT-MS-300	\$2011	MT-MG-300	\$1746	85 lbs.	9
30 x 36	MT-MS-303	2036	MT-MG-303	1776	95 lbs.	10

MT-MG-300  
Shown



## MIXER EQUIPMENT TABLE

28" Work Height

Size	Model #	Price	Wt.	Cu. Ft.
24" x 30"	AG-MP-30	\$1710	65 lbs.	4

Add 15" x 20" Drawer **SS-1520 \$539**

Shown with  
Optional Drawer



### CASTERS

MAINTAINS 24" WORKING HEIGHT

5" Swivels Each Set with 2 Brakes

For Use with  
Stainless Steel Legs

TA-25ES \$394 set/4

For Use with  
Galvanized Legs

TA-25EG \$394 set/4

## WALL MOUNTED TABLES



Must Be Installed In Cinder Block Wall  
Or Equal For Necessary Support



- Rolled Rim
- 1 1/2" Backsplash

24"  
WIDE

Length	Model #	Price
30"	FSS-W-240	\$1452
24"	FSS-W-242	1318
36"	FSS-W-243	1452
48"	FSS-W-244	1574
60"	FSS-W-245	1719
72"	FSS-W-246	1852
84"	FSS-W-247	2495
96"	FSS-W-248	2665

30"  
WIDE

Length	Model #	Price
30"	FSS-W-300	\$1528
24"	FSS-W-302	1371
36"	FSS-W-303	1572
48"	FSS-W-304	1689
60"	FSS-W-305	1856
72"	FSS-W-306	2019
84"	FSS-W-307	2598
96"	FSS-W-308	2867



Ship Via UPS

# STANDS

## Equipment Stands



### EQUIPMENT STANDS WITH UNDERSHELF NSF

24" Working Height • 14 Ga. Type 304 Series • Up to 1000 lb. Load Capacity



Optional Heavy Duty Casters

TA-255 Set of 4 \$539

TA-256 Set of 6 714

Each set supplied with 2 Brakes

Length	Stainless Steel				Galvanized				Wt.	Cu. Ft.
	24" WIDE	Price	30" WIDE	Price	24" WIDE	Price	30" WIDE	Price		
2'	ES-242	\$1225	ES-302	\$1281	EG-242	\$1073	EG-302	\$1098	43 lbs.	4
3'	ES-243	1359	ES-303	1436	EG-243	1184	EG-303	1227	56 lbs.	6
4'	ES-244	1489	ES-304	1597	EG-244	1330	EG-304	1366	74 lbs.	8
5'	ES-245	1624	ES-305	1763	EG-245	1407	EG-305	1504	84 lbs.	9
6'	ES-246	1757	ES-306	1919	EG-246	1518	EG-306	1638	102 lbs.	11
7'	ES-247	2192	ES-307	2943	EG-247	1860	EG-307	2555	120 lbs.	13
8'	ES-248	2241	ES-308	2993	EG-248	1908	EG-308	2606	135 lbs.	15

For 36" Wide Equipment Stands Add TA-59 291 per table

NSF



### EQUIPMENT STANDS WITH UNDERSHELF & CASTERS

24" Working Height • 14 Ga. Type 304 Stainless Steel • Up to 1000 lb. Load Capacity



Includes Four Heavy Duty TA-255 5" Swivel Casters, Two with Brakes

Length	30" WIDE	Price	Wt.	Cu. Ft.
2'	ES-302C	\$1781	51 lbs.	4
3'	ES-303C	1933	68 lbs.	6
4'	ES-304C	2090	85 lbs.	8
5'	ES-305C	2250	102 lbs.	9
6'	ES-306C	2402	119 lbs.	11



Wood Top Cutting Board w/ Plate Shelf\*

\*Must Order Cutting Board When Ordering Plate Shelf



Stainless Steel Cutting Surface

#### Optional Equipment Stand Accessories

L	Adj. S/S Cutting Surface		Adj. Wood Cutting Board		Adj. S/S Plate Shelf		Wt.	Cu. Ft.
	Model #	Price	Model #	Price	Model #	Price		
2'	TA-812	\$456	TA-922	\$487	TA-962	\$470	28 lbs.	1
3'	TA-813	681	TA-923	550	TA-963	532	30 lbs.	2
4'	TA-814	911	TA-924	617	TA-964	587	34 lbs.	3
5'	TA-815	1136	TA-925	683	TA-965	651	37 lbs.	3
6'	TA-816	1367	TA-926	752	TA-966	711	40 lbs.	4
7'	TA-817	1594	TA-927	884	TA-967	885	56 lbs.	5
8'	TA-818	1824	TA-928	1011	TA-968	1030	64 lbs.	5

### EQUIPMENT FILLER TABLES NSF

- Heavy Gauge Stainless Steel
- 1-1/2" Backsplash
- Stainless Steel Legs
- Stainless Steel Adjustable Bullet Feet

#### Open Base

Size	Model #	Price	Wt.	Cu. Ft.
12" x 24"	TFMS-122	\$877	22 lbs.	2
12" x 30"	TFMS-120	949	31 lbs.	2
12" x 36"	TFMS-123	1011	39 lbs.	2
15" x 24"	TFMS-152	964	25 lbs.	2
15" x 30"	TFMS-150	1051	33 lbs.	2
15" x 36"	TFMS-153	1111	41 lbs.	3
18" x 24"	TFMS-182	971	27 lbs.	2
18" x 30"	TFMS-180	1063	35 lbs.	3
18" x 36"	TFMS-183	1098	43 lbs.	3



All Filler Tables Must Be Placed Between 2 Other Pieces Of Equipment For Stability.

#### w/ Adjustable Stainless Steel Undershelf

Size	Model #	Price	Wt.	Cu. Ft.
15" x 24"	TFMSU-152	\$1215	28 lbs.	2
15" x 30"	TFMSU-150	1241	36 lbs.	2
18" x 24"	TFMSU-182	1415	38 lbs.	2
18" x 30"	TFMSU-180	1349	41 lbs.	2



# WOOD TOPS

## Wood Top Bakers Tables



All Wood Top Bakers Tables  
On Page 56 & 57 Feature  
1-3/4" Thick Wood Top



= Ship Via UPS

### FLAT TOP - OPEN BASE STYLE

#### Stainless Steel Base

L	24" WIDE	Price	Wt. (lbs.)	Cu. Ft.	30" WIDE	Price	Wt. (lbs.)	Cu. Ft.	36" WIDE	Price	Wt. (lbs.)	Cu. Ft.
4'	TH2S-244	\$1168	80	6	TH2S-304	\$1338	100	7	TH2S-364	\$1779	115	8
5'	TH2S-245	1308	95	7	TH2S-305	1524	120	9	TH2S-365	2029	135	11
6'	TH2S-246	1456	115	9	TH2S-306	1709	140	11	TH2S-366	2283	155	13
7'	TH2S-247	1791	135	10	TH2S-307	2144	155	12	TH2S-367	2856	180	15
8'	TH2S-248	1818	155	12	TH2S-308	2389	185	14	TH2S-368	3105	215	17



#### Galvanized Base

L	24" WIDE	Price	Wt. (lbs.)	Cu. Ft.	30" WIDE	Price	Wt. (lbs.)	Cu. Ft.	36" WIDE	Price	Wt. (lbs.)	Cu. Ft.
4'	TH2G-244	\$918	80	6	TH2G-304	\$1026	100	7	TH2G-364	\$1227	115	8
5'	TH2G-245	1014	95	7	TH2G-305	1157	120	9	TH2G-365	1367	135	11
6'	TH2G-246	1111	115	9	TH2G-306	1283	140	11	TH2G-366	1497	155	13
7'	TH2G-247	1353	135	10	TH2G-307	1600	155	12	TH2G-367	1966	180	15
8'	TH2G-248	1593	155	12	TH2G-308	1849	185	14	TH2G-368	1992	215	17

### FLAT TOP - WITH ADJUSTABLE UNDERSHELF

#### Stainless Steel Base

L	24" WIDE	Price	Wt. (lbs.)	Cu. Ft.	30" WIDE	Price	Wt. (lbs.)	Cu. Ft.	36" WIDE	Price	Wt. (lbs.)	Cu. Ft.
3'	H2S-243	\$1168	75	4	H2S-303	\$1332	90	5	H2S-363	\$1758	105	6
4'	H2S-244	1242	95	6	H2S-304	1410	115	7	H2S-364	1829	135	8
5'	H2S-245	1410	110	7	H2S-305	1613	140	9	H2S-365	2103	160	11
6'	H2S-246	1574	130	9	H2S-306	1824	160	11	H2S-366	2369	185	13
7'	H2S-247	1954	150	10	H2S-307	2297	185	12	H2S-367	2988	215	15
8'	H2S-248	2200	180	12	H2S-308	2541	215	14	H2S-368	3235	255	17



#### Galvanized Base

L	24" WIDE	Price	Wt. (lbs.)	Cu. Ft.	30" WIDE	Price	Wt. (lbs.)	Cu. Ft.	36" WIDE	Price	Wt. (lbs.)	Cu. Ft.
3'	H2G-243	\$959	75	4	H2G-303	\$1066	90	5	H2G-363	\$1268	105	6
4'	H2G-244	1031	95	6	H2G-304	1137	115	7	H2G-364	1343	135	8
5'	H2G-245	1159	110	7	H2G-305	1292	140	9	H2G-365	1508	160	11
6'	H2G-246	1286	130	9	H2G-306	1446	160	11	H2G-366	1672	185	13
7'	H2G-247	1577	150	10	H2G-307	1829	185	12	H2G-367	2052	215	15
8'	H2G-248	1822	180	12	H2G-308	2075	215	14	H2G-368	2297	255	17

### COVED TOP W/ 4" SPLASH - OPEN BASE STYLE

Features Coved Risers & Allow For Easy Cleaning

#### Stainless Steel Base

Length	30" WIDE	Price	Wt.	Cu. Ft.	36" WIDE	Price	Wt.	Cu. Ft.
4'	TBS-304	\$2622	120	12	TBS-364	\$3447	120	14
5'	TBS-305	2798	150	15	TBS-365	3689	150	18
6'	TBS-306	3283	180	18	TBS-366	4209	180	21
7'	TBS-307	3982	210	21	TBS-367	5253	210	24
8'	TBS-308	4222	240	24	TBS-368	5497	240	28

#### Galvanized Base

Length	30" WIDE	Price	Wt.	Cu. Ft.	36" WIDE	Price	Wt.	Cu. Ft.
4'	TBG-304	\$1990	120	12	TBG-364	\$2622	120	14
5'	TBG-305	2130	150	15	TBG-365	2821	150	18
6'	TBG-306	2559	180	18	TBG-366	3379	180	21
7'	TBG-307	3266	210	21	TBG-367	4322	210	24
8'	TBG-308	3508	240	24	TBG-368	4566	240	28



For Special Sizes & Configurations Of  
Wood Top Tables, Consult Factory.

For Additional Accessories & Modifications  
See Page 59 - 65 for Details

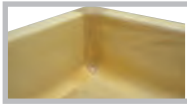

Coved Risers &  
Allow For Easy Cleaning!



# WOOD TOPS

## Wood Top Tables

### COVED TOP W/ 4" SPLASH & ADJUSTABLE UNDERSHELF



#### Stainless Steel Base

L	30" WIDE	Price	Wt.	Cu. Ft.	36" WIDE	Price	Wt. (lbs.)	Cu. Ft.
4'	BS-304	\$2741	160	15	BS-364	\$3566	190	17
5'	BS-305	2948	185	18	BS-365	3838	220	21
6'	BS-306	3372	225	21	BS-366	4457	265	25
7'	BS-307	4215	240	25	BS-367	5493	290	29
8'	BS-308	4457	275	28	BS-368	5735	350	33

#### Galvanized Base

L	30" WIDE	Price	Wt.	Cu. Ft.	36" WIDE	Price	Wt. (lbs.)	Cu. Ft.
4'	BG-304	\$2108	160	15	BG-364	\$2741	190	17
5'	BG-305	2279	185	18	BG-365	2962	220	21
6'	BG-306	2738	225	21	BG-366	3564	265	25
7'	BG-307	3503	240	25	BG-367	4558	290	29
8'	BG-308	3747	275	28	BG-368	4803	350	33

### COVED TOP W/ 4" SPLASH & 3-TIER DRAWERS



BST-306L Shown

#### Stainless Steel Base

L	30" WIDE	Price	Wt.	Cu. Ft.	36" WIDE	Price	Wt. (lbs.)	Cu. Ft.
4'	BST-304LorR	\$4369	365	46	BST-364LorR	\$5758	390	54
5'	BST-305LorR	4652	400	56	BST-365LorR	6045	430	66
6'	BST-306LorR	5013	440	67	BST-366LorR	6519	475	78
7'	BST-307LorR	5321	465	77	BST-367LorR	7384	505	91
8'	BST-308LorR	5562	500	87	BST-368LorR	7645	560	103

#### Galvanized Base

L	30" WIDE	Price	Wt.	Cu. Ft.	36" WIDE	Price	Wt. (lbs.)	Cu. Ft.
4'	BGT-304LorR	\$3785	365	46	BGT-364LorR	\$4950	390	54
5'	BGT-305LorR	3926	400	56	BGT-365LorR	5108	430	66
6'	BGT-306LorR	4386	440	67	BGT-366LorR	5642	475	78
7'	BGT-307LorR	5138	465	77	BGT-367LorR	6527	505	91
8'	BGT-308LorR	5382	500	87	BGT-368LorR	6834	560	103

# COUNTERTOPS



- 16 Gauge Type 304 S/S
- #4 Satin Finish
- No-Drip "Mirror Hi-Lite Polish" Edge

- Stud Welded Hat Channel
- Sound Deadening

Countertop Shown  
with Optional Side Splash  
& Sink Bowl



Size	Flat Top	Price	Approx. Wt.	Approx. Cu. Ft.	5" Backsplash	Price	Approx. Wt.	Approx. Cu. Ft.	10" Backsplash	Price	Approx. Wt.	Approx. Cu. Ft.
25" x 30"	VCTC-240	\$1170	28 lbs.	4	VCTF-240	\$1314	28 lbs.	4	VKCT-240	\$1462	28 lbs.	4
25" x 36"	VCTC-243	1170	39 lbs.	5	VCTF-243	1314	39 lbs.	5	VKCT-243	1462	39 lbs.	5
25" x 48"	VCTC-244	1292	49 lbs.	6	VCTF-244	1443	49 lbs.	6	VKCT-244	1608	49 lbs.	6
25" x 60"	VCTC-245	1421	58 lbs.	8	VCTF-245	1571	58 lbs.	8	VKCT-245	1748	58 lbs.	8
25" x 72"	VCTC-246	1544	68 lbs.	9	VCTF-246	1706	68 lbs.	9	VKCT-246	1895	68 lbs.	9
25" x 84"	VCTC-247	1910	85 lbs.	11	VCTF-247	2045	85 lbs.	11	VKCT-247	2273	85 lbs.	11
25" x 96"	VCTC-248	2049	95 lbs.	12	VCTF-248	2191	95 lbs.	12	VKCT-248	2429	95 lbs.	12
25" x 120"	VCTC-2410	2804	201 lbs.	26	VCTF-2410	2988	201 lbs.	26	VKCT-2410	3318	201 lbs.	26
30" x 30"	VCTC-300	1257	38 lbs.	5	VCTF-300	1381	38 lbs.	5	VKCT-300	1535	38 lbs.	5
30" x 36"	VCTC-303	1257	45 lbs.	6	VCTF-303	1381	45 lbs.	6	VKCT-303	1535	45 lbs.	6
30" x 48"	VCTC-304	1393	57 lbs.	8	VCTF-304	1537	57 lbs.	8	VKCT-304	1719	57 lbs.	8
30" x 60"	VCTC-305	1551	69 lbs.	9	VCTF-305	1700	69 lbs.	9	VKCT-305	1889	69 lbs.	9
30" x 72"	VCTC-306	1748	76 lbs.	11	VCTF-306	1855	76 lbs.	11	VKCT-306	2062	76 lbs.	11
30" x 84"	VCTC-307	2013	95 lbs.	13	VCTF-307	2142	95 lbs.	13	VKCT-307	2382	95 lbs.	13
30" x 96"	VCTC-308	2179	107 lbs.	15	VCTF-308	2195	107 lbs.	15	VKCT-308	2631	107 lbs.	15
30" x 120"	VCTC-3010	3130	235 lbs.	32	VCTF-3010	3201	235 lbs.	32	VKCT-3010	3564	235 lbs.	32

# POLY TOPS

## Poly Top Bakers Tables



### FLAT TOP

#### Tubular Base



Length	24" WIDE	Price	30" WIDE	Price	Wt.	Cu. Ft.
4'	TSPT-244	\$1491	TSPT-304	\$1615	77 lbs.	8
5'	TSPT-245	1633	TSPT-305	1748	89 lbs.	9
6'	TSPT-246	2181	TSPT-306	2311	117 lbs.	11
7'	TSPT-247	2431	TSPT-307	2659	130 lbs.	13
8'	TSPT-248	2680	TSPT-308	2779	141 lbs.	15
9'	TSPT-249	2832	TSPT-309	2988	180 lbs.	17
10'	TSPT-2410	3063	TSPT-3010	3146	201 lbs.	19

#### With Undershef



Length	24" WIDE	Price	30" WIDE	Price	Wt.	Cu. Ft.
4'	SPT-244	\$1599	SPT-304	\$1709	89 lbs.	8
5'	SPT-245	1738	SPT-305	1852	102 lbs.	9
6'	SPT-246	2268	SPT-306	2429	125 lbs.	11
7'	SPT-247	2534	SPT-307	2754	141 lbs.	13
8'	SPT-248	2775	SPT-308	2991	168 lbs.	15
9'	SPT-249	2937	SPT-309	3092	196 lbs.	16
10'	SPT-2410	3168	SPT-3010	3250	230 lbs.	17

### 6" BACKSPLASH

#### Tubular Base



Length	24" WIDE	Price	30" WIDE	Price	Wt.	Cu. Ft.
4'	TSPS-244	\$1496	TSPS-304	\$1599	87 lbs.	12
5'	TSPS-245	1650	TSPS-305	1763	101 lbs.	15
6'	TSPS-246	2201	TSPS-306	2351	131 lbs.	18
7'	TSPS-247	2523	TSPS-307	2732	145 lbs.	21
8'	TSPS-248	2750	TSPS-308	2956	160 lbs.	24
9'	TSPS-249	2907	TSPS-309	3103	210 lbs.	16
10'	TSPS-2410	3087	TSPS-3010	3175	235 lbs.	17

#### With Undershef



Length	24" WIDE	Price	30" WIDE	Price	Wt.	Cu. Ft.
4'	SPS-244	\$1700	SPS-304	\$1811	99 lbs.	12
5'	SPS-245	1932	SPS-305	1974	113 lbs.	15
6'	SPS-246	2504	SPS-306	2556	143 lbs.	18
7'	SPS-247	2842	SPS-307	2938	167 lbs.	21
8'	SPS-248	3074	SPS-308	3128	175 lbs.	24
9'	SPS-249	3122	SPS-309	3309	225 lbs.	25
10'	SPS-2410	3296	SPS-3010	3385	242 lbs.	28

## ACCESSORIES

<b>TA-41</b>	Replacement Poly-Vance 5/8" Cutting Board	\$93 /sq. ft.
<b>TA-63</b>	Removable Shelving (In Addition To Standard Shelf)	395 /table
<b>TA-82</b>	Scrap Chute	251 ea.
<b>SHD-2020</b>	Enclosed Drawers - See Page 64 For Details	1051 ea.



TA-84C Shown

#### KNIFE RACKS

<b>TA-84A</b>	Rolled Rim Type	\$366
<b>TA-84B</b>	Poly Table Type	366
<b>TA-84C</b>	Square Edge Type	366



17 Years in a Row!

# TABLE MODS

## Smart Table Modifications

### TOP MODIFICATIONS



**TA-56**  
5" NSF Partition

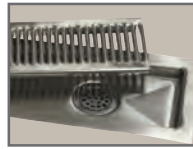

**TA-523**  
Drop-In Urn Trough



**CDR-5**  
Condiment Holder

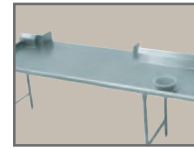

**TA-84**  
Pass-Thru



**TA-108**  
Grommet For Cords

<b>CDR-5</b>	Condiment Holder (Accommodates 5 Bins)	<b>\$823</b>
<b>TA-1</b>	Notch Backsplash For Roll Up Door w/ Pass-Thru	<b>149</b>
<b>TA-3</b>	Stainless Steel Hat Channel & Gusset Upgrade	<b>54 /lin. ft.</b>
<b>TA-7</b>	10" Partial Splash	<b>80 /lin. ft.</b>
<b>TA-8</b>	Column Notch in Rear Splash (Includes Splash)	<b>727 ea.</b>
<b>TA-10</b>	5" Partial Splash	<b>67 /lin. ft.</b>
<b>TA-12</b>	Countertop Edge	<b>668 /table</b>
<b>TA-22</b>	Square Edge Table	<b>N/C</b>
<b>TA-28</b>	Cut-Out For Cold Well. Includes Louvered Doors	<b>1545 /cut out</b>
<b>TA-29</b>	16 Ga. 304 Rear Splash Capping Strip w/Adhesive Backing	<b>66 /lin. ft.</b>
<b>TA-30</b>	1-1/2" Side Splash	<b>92 ea.</b>
<b>TA-30A</b>	1-1/2" Turn Up For Table Tops	<b>42 /lin. ft.</b>
<b>TA-31</b>	5" Side Splash	<b>173 ea.</b>
<b>TA-32</b>	10" Side Splash	<b>339 ea.</b>
<b>TA-34</b>	Top Cut-Out for Drop-In Style Units	<b>254 /cut out</b>
<b>TA-34A</b>	Top Cut-Out for Undermount Well	<b>427 /cut out</b>
<b>TA-35</b>	Splash Cut-Out	<b>185 /cut out</b>
<b>TA-41</b>	Poly-Vance 5/8" Cutting Board	<b>93 /sq. ft.</b>
<b>TA-56</b>	5" NSF Partition	<b>465</b>
<b>TA-56A</b>	18" NSF Partition	<b>670</b>
<b>TA-57</b>	Prepare Welded Field Joint (Welded in field by others)	<b>257 ea.</b>
<b>TA-57A</b>	Bolted Field Joint (Bolted in field by others)	<b>543 ea.</b>
<b>TA-57B</b>	Hairline Field Joint	<b>728 ea.</b>
<b>TA-58</b>	Stepdown to 24" Working Height	<b>1148 ea.</b>
<b>TA-64</b>	Urn Trough (Factory installation only)	<b>156 /lin. ft.</b>
<b>TA-75</b>	Mitered Edge	<b>744 ea.</b>
<b>TA-76</b>	Paint on Sound Deadening	<b>534 /table</b>
<b>TA-79</b>	Flour Trough (Factory installation only)	<b>196 /lin. ft.</b>
<b>TA-82</b>	Scrap Chute (6" dia. opening)	<b>251</b>
<b>TA-84</b>	Simple Pass-Thru	<b>659 /lin. ft.</b>
<b>TA-87</b>	Enclosed Rear Splash	<b>92 /lin. ft.</b>
<b>TA-91</b>	Poly Retaining Clips Includes TA-22 (S/S top table)	<b>461 /table</b>
<b>TA-93</b>	Wall Brackets (Includes 2. For 5" & 10 1/2" splash only)	<b>80 /table</b>

<b>TA-96A</b>	Can Opener Provision for Openers with Bolt-on Base (Customer to provide location)	<b>\$221 ea.</b>
<b>TA-96B</b>	Can Opener Surface Mount Provision with 4" S/S Tube for Openers w/o Base (Customer to provide location)	<b>555 ea.</b>
<b>TA-96C</b>	Can Opener Spacer Plate Provision for Use on Tables With Countertop Edge & Can Opener Base (Customer to provide location)	<b>342 ea.</b>
<b>TA-100</b>	Bull Nose All Sides of Worktable	<b>N/C</b>
<b>TA-101</b>	Rear Tray Lock	<b>92 /lin. ft.</b>
<b>TA-106</b>	Mirror HI-LITE Edge	<b>415 /table</b>
<b>TA-107</b>	Vacuum Breaker Holes on Tables (Includes Back-splash with 2" Return)	<b>380</b>
<b>TA-108</b>	2" Hole with Grommet for Appliance Cord	<b>137 ea.</b>
<b>TA-112</b>	Hubble Outlet	<b>591 ea.</b>
<b>TA-113</b>	Notch Top for Buyout Unit	<b>854 ea.</b>
<b>TA-366A</b>	Heavy Duty Understructure Top	<b>335 /table</b>
<b>TA-502</b>	Install Advance Tabco Drop-In Hand Sinks or Hot Food Unit In Work Table Top (Hot Food Unit Requires TA-34 Top Cut-Out & TA-27 Control Panel. Does not include wiring. Consult factory)	<b>554 ea.</b>
<b>TA-503</b>	Install Advance Tabco 7-PS-42/7-PS-43 Hand Sinks for Countertops (Includes Cut-Out)	<b>438 ea.</b>
<b>TA-521</b>	Drop-In urn Trough 1'	<b>155 ea.</b>
<b>TA-522</b>	Drop-In urn Trough 2'	<b>308 ea.</b>
<b>TA-523</b>	Drop-In urn Trough 3'	<b>463 ea.</b>
<b>TA-524</b>	Drop-In urn Trough 4'	<b>618 ea.</b>
<b>TA-525</b>	Drop-In urn Trough 5'	<b>638 ea.</b>
<b>TA-526</b>	Drop-In urn Trough 6'	<b>676 ea.</b>
<b>TA-527</b>	Drop-In urn Trough 7'	<b>716 ea.</b>
<b>TA-528</b>	Drop-In urn Trough 8'	<b>737 ea.</b>
<b>TA-529</b>	Drop-In urn Trough 9'	<b>782 ea.</b>
<b>TA-550</b>	Install Customer Supplied Buyout Items (Does not include wiring. Consult factory)	<b>Call for Price</b>
<b>TA-551</b>	Installation of Customer Supplied Hot Food Wells. (Requires TA-34 Top Cut-Out & TA-27 Control Panel. Does not include wiring. Consult factory)	<b>825 ea.</b>

# TABLE MODS

Smart Table Modifications

Call For Installation of Buyout Equipment!

## BASE MODIFICATIONS

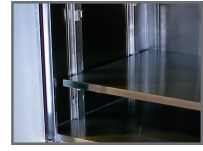
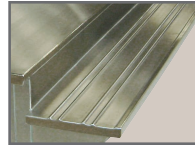

	TA-39 Louvered Hinged Doors	TA-73 Drop-Down Tray Slide	TA-74 Solid Tray Slide	TA-900 Adjustable Table Height	TA-116 Adj. Mid-Shelf	
TA-4	Removable Access Panel		\$187 /lin. ft.	TA-46	Door Locks	\$286 ea.
TA-4A	Louvered Panel		504 /lin. ft.	TA-48	12"x12" Cut-Out in Back Panel/Undershelf for Plumbing	240
TA-5	Curb Mounting Provision		210 ea.	TA-54	Removable Kick Plate	155 /lin. ft.
TA-15	Provision for Built In Drawer Warmer		404 ea.	TA-55	Remove Back Panel (on Enclosed Base)	N/C
TA-23	Legs Welded to Undershelf or Cross-Rails, Shipped Set Up & Crated.		401 /table	TA-63	Removable Shelving (In addition to standard shelf & table width)	395 /table.
TA-23A	Table Legs Welded To Leg Gussets & Undershelf or Cross-Bracing, Shipped Set Up & Crated.		506 /table	TA-70	S/S Tubular Tray Divider (12" sections)	737 ea.
TA-24	Shell Crating		296 /table	TA-73	Tubular Tray Slide w/Dropdown (Stationary Tray Slide Available. Factory installation only)	268 /lin. ft.
TA-27	Control Panel (Must add TA-34A)		291 /lin. ft.	TA-74	Solid Tray Slide	368 /lin. ft.
TA-36-HINGED	Hinged 30" Stainless Steel Door		463 /door	TA-92	12" Apron (in front of sink)	169 /lin. ft.
TA-36-SLIDING	Sliding 30" Stainless Steel Door		463 /door	TA-92A	17" Stainless Steel Apron to Cover Sink Bowls and Support Lever Drain Handles	254 /lin. ft.
TA-36B	1/2 Height Stainless Steel Hinge Doors		470 set/2	TA-116	Adjustable Enclosed Base Cabinet Mid Shelf- Add to Price of Enclosed Base Table with Fixed Mid Shelf (M) on Page 48 or 49. Shelves Over 36" In Length Require Multiple Sections With Center Partition. For Partial Shelves Add To Price Of Shelf On Page 66.	800 ea.
TA-36C	Hinged door with Trash Flap		649 /ea.	TA-130	Cutlery Dispenser Holder (Undercounter Mounted)	226 /lin. ft.
TA-37	Stainless Enclosed Base		364 /lin. ft.	TA-135	Plate Shelf (Undercounter Mounted)	270 /lin. ft.
TA-39	24" Louvered Hinged Doors		668 /door	TA-205	Connect Cafeteria Items (Per Joint Between 2 Tables. Requires Casters)	539 /set
TA-40	Remove Undershelf in Cabinet Base For Slide in Buyout		N/C	TA-900	Upgrade Table To Be Height Adjustable In Field (Up to 6' Only. Unit Ships Set Up)	4653 ea.
TA-42-24	Interior Partition (2.5"x24")		214 ea.			
TA-42-30	Interior Partition (2.5"x30")		214 ea.			
TA-42-36	Interior Partition (2.5"x36")		214 ea.			
TA-43	Filler Panel (3"x30" with Flanged Feet)		456 ea.			
TA-44	K.D. Aluminum Pan Rack Slides (6 slides. Table min. lgth. 30")		644			
TA-45	K.D. Aluminum Glass Rack Slides (3 slides. Table min. lgth. 3 feet)		588			

## ELECTRICAL & DATA PORT OUTLETS



TA-62  
Duplex  
Outlet



TA-62A  
GFI Duplex  
Outlet



TA-62D  
GFI  
Doghouse  
Outlet



TA-62F  
Empty  
Junction  
Box

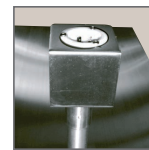

TA-112  
Hubble  
Outlet

TA-62A	GFI Duplex Outlet & Cover Plate in a VKS or KSS (1" Deep) Splash. NEMA 5-20R	\$421 ea.	TA-62E	Upgrade Outlet to a NEMA 6-20R or Equiv.	\$322 ea.
TA-62C	GFI Duplex Outlet & Cover Plate Below Shelf Top. NEMA 5-20R	458 ea.	TA-62F	Junction Box (empty) Below Table Top. Includes 1 Gang Size, Stainless Steel Face Plate	222 ea.
TA-62D	GFI Duplex Outlet & Cover Plate in a Doghouse. NEMA 5-20R	487 ea.	TA-112	Hubble Outlet	591 ea.
			TA-622	CAT-6 Data Port Connection Provided (unless otherwise specified. Cable Not Included)	435 ea.

Email in your specifications to [smartfab@advancetabco.com](mailto:smartfab@advancetabco.com)

# MORE TABLE MODS

## Smart Table Modifications

### OVERSHELF & POT RACK MODIFICATIONS

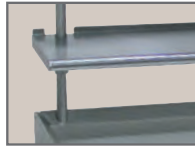

**TA-9A**  
1" Turn Up

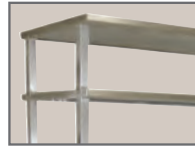

**TA-22A**  
Square Edge



**TA-71**  
Heat Lamp Mounting Provision



**TA-100A**  
Bull Nose

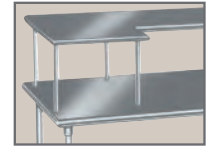

**TA-102**  
24" x 24" Extension

<b>TA-9A</b>	Partial 1" Turn-Up for all Table Mt. Shelves	\$42 /lin. ft.
<b>TA-22A</b>	Square Edge on Overshelf	98
<b>TA-26-10</b>	Welded Wall Shelf Brackets for 10" Wide Shelf	244 /shelf
<b>TA-26-12</b>	Welded Wall Shelf Brackets for 12" Wide Shelf	244 /shelf
<b>TA-26-15</b>	Welded Wall Shelf Brackets for 15" Wide Shelf	244 /shelf
<b>TA-26-18</b>	Welded Wall Shelf Brackets for 18" Wide Shelf	244 /shelf
<b>TA-47</b>	Shelf Mounting Bracket for Existing Table	89 /shelf
<b>TA-49</b>	Wall Shelf 2" Offset	172 /shelf
<b>TA-60</b>	Special Sizing Charge for Shelves (Must Order Larger Unit to be Cut Down to Smaller Size)	N/C
<b>TA-71</b>	Heat Lamp Mounting Provision (Heat Lamp Installed By Others)	155 ea.
<b>TA-71A</b>	Heat Lamp Remote Control Bracket	305 ea.
<b>TA-78</b>	Additional Lin. Ft. Past 12' For Table Mt. Shelf (For ODS, OTS, TS, DS & WS Shelving only)	181 /lin. ft.
<b>TA-77</b>	Check Minder Shelf Provision (Factory install only)	56 /lin. ft.
<b>TA-83</b>	Spice Bins	236 ea.

<b>TA-84A</b>	Knife Rack for Rolled Rim Tables	\$366 ea.
<b>TA-84B</b>	Knife Rack for Poly Top Tables	366 ea.
<b>TA-84C</b>	Knife Rack for Square Edge Tables	366 ea.
<b>TA-86</b>	Stainless Steel Pot Hooks	25 ea.
<b>TA-89</b>	Double Sided Plated Pot Hooks (Package of 4)	65 /pack
<b>TA-89A</b>	Single Sided Plated Pot Hooks (Package of 4)	60 /pack
<b>TA-98</b>	Stainless Steel Flat Bar in lieu of Chain	296 ea.
<b>TA-99</b>	16 Ga. S/S 304 Upgrade for Wall & Over Shelves	25 /lin. ft.
<b>TA-100A</b>	Bull Nose All Sides of Shelf	N/C
<b>TA-100R</b>	Bull Nose Three Sides of Shelf w/ Rear Turn Up	118
<b>TA-102</b>	24" x 24" Extension for Microwave or Computer Shelf (Add to OTS and ODS Shelves. See page 68)	406 ea.
<b>TA-103</b>	24" Wide PT Shelf (36" Min Length. Mid mt only. See Pg. 73. Add to 18" Wide Shelf)	121 /lin. ft.
<b>TA-104</b>	Additional Length Over 12' (Add to 18" Shelf. (PA & CU Shelving Only. Max. Length is 14' as Single Piece)	261 /lin. ft.

### UNDERSHELF MODIFICATIONS

<b>TA-9</b>	1-1/2" Turn-Up for Undershelves	\$42 /lin. ft.
<b>TA-17</b>	Upgrade Undershelf to a Marine Edge (Must add TA-23)	461 ea.
<b>TA-48</b>	12"x12" Cut-Out in Back Panel or Undershelf for Plumbing	240

<b>TA-94</b>	Upgrade 16 Ga. 304 S/S Undershelf	\$54 /lin. ft.
<b>TA-94A</b>	Upgrade 14 Ga. 304 S/S Undershelf	68 /lin. ft.
<b>TA-366</b>	Reinforced Understructure For Undershelves	335 /table

### SIZE MODIFICATIONS

<b>TA-33</b>	Special Working Height	\$101
<b>TA-59</b>	36" Wide Equipment Stand	291 ea.
<b>TA-6</b>	Extra Length for Standard Tables Over 12' (Tables Over 14' Require Field Joint TA-57)	385 /lin. ft.
<b>TA-61</b>	Special Sizing Charge (Larger Unit Cut Down to Smaller Size)	N/C
<b>TA-61A</b>	Special Modification Charge	254

<b>TA-65</b>	Enclosed Base Units Over 12' (Open Base Table)	\$499 /lin. ft.
<b>TA-66</b>	Enclosed Base Units Over 12' (Sliding Door Units)	727 /lin. ft.
<b>TA-67</b>	Enclosed Base Units Over 12' (Hinged Door Units)	770 /lin. ft.
<b>TA-105</b>	Modify Enclosed Base Table w/ Drawers to 24" Width	306 /table
<b>TA-110</b>	Modify Enclosed Base Table w/ Drawers to 36" Width	58 /lin. ft.

### LEG MODIFICATIONS

<b>TA-16</b>	Galvanized Leg w/ Plastic Bullet Foot (34 1/2" Total Length)	\$58 ea.
<b>TA-16-4</b>	Galvanized Legs w/ Plastic Bullet Feet (34 1/2" Total Length)	232 set/4
<b>TA-16-6</b>	Galvanized Legs w/ Plastic Bullet Feet (34 1/2" Total Length)	348 set/6
<b>TA-19</b>	Flanged Stainless Steel Bullet Feet (34 1/2" Total Length)	56 ea.
<b>TA-20</b>	Stainless Steel Leg w/ S/S Bullet Foot (34 1/2" Total Length)	67 ea.
<b>TA-20-4</b>	Stainless Steel Legs w/ S/S Bullet Feet (34 1/2" Total Length)	268 set/4

<b>TA-20-6</b>	Stainless Steel Legs w/ S/S Bullet Feet (34 1/2" Total Length)	\$402 set/6
<b>TA-21</b>	Stainless Steel Bullet Foot	26 ea.
<b>TA-68</b>	Relocate rear cross rail to center (for chairs/stools on both sides of table. For Open Base Tables Only)	111 ea.
<b>TA-72</b>	Leg to Wall Brace (Set per table)	297 /table
<b>TA-95</b>	Upgrade 16 Ga. 304 S/S Legs Only	127 /table

# TABLE ACCESSORIES

## Smart Table Accessories

Faucets Included Meet  
Federal Lead Free Standards



## COUNTERTOP INSTALLED HAND SINKS

- 4" Side Splashes
- K-52 Lead Free Compliant Deck Mounted Faucet
- Undermount Towel Dispenser
- 3-1/2" Basket Drain



### 7-PS-42 \$2665

Bowl Size: 10" x 14" x 5"  
Overall Size: 18-1/4" x 17-5/8"  
30 lbs. 2 cu. ft. 20 gauge

- 4" Side Splashes
- Deck Mounted Lead Free Compliant Gooseneck Spout
- Undermount Towel Dispenser
- Knee Operated Valve
- 3-1/2" Basket Drain



### 7-PS-43 \$3085

Bowl Size: 10" x 14" x 5"  
Overall Size: 18-1/4" x 17-5/8"  
36 lbs. 2 cu. ft. 20 gauge



7-PS-43 Shown in Table

For Factory Installation Add **TA-503 \$438**  
Can Be Purchased Separately For In-Field Installation

## DROP-IN HAND SINKS & WATER STATIONS

For Custom Cut-Out Add **TA-34 \$254** For Factory Installation Add **TA-502 \$554**

**IMPROVED!**  
Stronger Actuator



### DI-1-5SP \$1472

#### 6" Tapered Side Splash

Splash on Rear and Both Sides  
**10" x 14" x 5" Bowl**  
Overall: 13" x 19"  
Cut-out: 12 1/4" x 18 1/4"  
16 lbs. 2 cu. ft. 20 gauge



### DI-1-10SP \$1582

#### 6" Tapered Side Splash

Splash on Rear and Both Sides  
**10" x 14" x 10" Bowl**  
Overall: 13" x 19"  
Cut-out: 12 1/4" x 18 1/4"  
18 lbs. 2 cu. ft. 20 gauge



### DI-1-9 \$1000

Removable Electro-Polished  
Stainless Steel Grill  
1 1/2" IPS Basket Drain  
Overall: 12" x 14"  
Cut-Out Size: 11 1/4" x 13 1/4"  
15 lbs. 3 cu. Ft.

## Water Stations with Ice Bins

Includes K-54 8-1/4" Filler Faucet With "Push-Back" Acrylic Lever Arm (Excludes D-24-SIBL)

**IMPROVED!**  
Stronger Actuator



Ice Bin Inside Dim.:  
8" x 13 1/2" x 10 13/16"  
Ice Capacity: 23 lbs.

### D-24-WSIBL \$1303

Removable Grate Covers Drip Pan  
13" Deep Insulated Ice Bin w/ S/S Steel Cover  
1" IPS Drain  
Outside Dim. 21" x 18"  
Cut-Out Size: 20 5/8" x 15 1/4"  
30 lbs. 5 cu. Ft.

**IMPROVED!**  
Stronger Actuator



Ice Bin Inside Dim.:  
13 1/2" x 18 3/4" x 10 13/16"  
Ice Capacity: 50 lbs.

### D-24-WSIBL2 \$1565

Removable Grate Covers Drip Pan  
13" Deep Insulated Ice Bin w/ S/S Steel Cover  
1" IPS Drain  
Outside Dim.: 18" x 21"  
Cut-Out Size: 15 1/4" x 20 5/8"  
47 lbs. 5 cu. Ft.

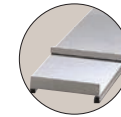

Includes Sliding  
Stainless Steel Cover



### D-24-SIBL \$1396

K-51 Deck Mounted Faucet  
Insulated Ice Bin w/ S/S Cover  
1" IPS Drain In Ice Bin  
Outside Dim.: 21" x 18"  
Cut-Out Size: 20 5/8" x 15 1/4"  
Factory Installed Only  
20 Gauge Galvanized Steel  
30 lbs. 5 cu. Ft.

Hand Sink Size:

9 1/2" x 11 1/2" x 6"

Ice Bin Inside Dim.:  
8" x 13 1/2" x 10 13/16"

Ice Capacity: 23 lbs.

Upgrade to a 12" Filler Faucet

Use **K-54OMIT**, Deduct **-\$385** and Add **K-54A \$576**

(K-54OMIT MUST be ordered with K-54A to receive upgrade)





# INTEGRAL SINKS

## Integral Sinks

### WELDED SINKS INTO TABLE TOP

Includes Lead Free Compliant Faucet & K-6 Basket Drain(s)



Flat Top, 1", 1-1/2" & 5 Backsplash Include Deck Mount Faucet

- Single Sink Bowl provided with K-50 Swing Spout Faucet
- Double Sink Bowls provided with K-53 Swing Spout Faucet

10" Backsplash Include Splash Mount Faucet

- Single & Double Sink Bowls provided with K-1 Swing Spout Faucet

Splash Mount Faucet Available On 5" Backsplash - Add TA-11Z \$42/lin. ft.



Flat Top  
w/ K-50  
Deck Mount  
Faucet Shown



10" Backsplash  
w/ K-1  
Splash Mount  
Faucet Shown

Size		Single Bowl		Double Bowl	
A	B	Model#	Price	Model#	Price
10"	14" x 5"	TA-11Q	\$1088	TA-11Q-2†	\$1988
10"	14" x 10"	TA-11F	1171	TA-11F-2†	2240
14"	16" x 12"	TA-11J	1232	TA-11J-2	2305
16"	20" x 8"	TA-11A**	1225	TA-11A-2**	2277
16"	20" x 12"	TA-11B**	1369	TA-11B-2**	2513
16"	20" x 14"	TA-11V**	1591	TA-11V-2**	2699
18"	18" x 14"	TA-11N	1395	TA-11N-2	2517
18"	24" x 14"	TA-11L	1412	TA-11L-2	2538
20"	20" x 8"	TA-11C*	1292	TA-11C-2*	2499
20"	20" x 12"	TA-11D*	1470	TA-11D-2*	2645
20"	20" x 14"	TA-11W*	1717	TA-11W-2*	2825
20"	24" x 14"	TA-11P	1499	TA-11P-2	2692
20"	30" x 14"	TA-11S*	1635	TA-11S-2*	3048
24"	24" x 14"	TA-11E*	1541	TA-11E-2*	2896
24"	30" x 14"	TA-11T*	1683	TA-11T-2*	3207
24"	36" x 14"	TA-11R*	1738	TA-11R-2*	3255
28"	20" x 12"	TA-11G*	1720	TA-11G-2*	3111

\* Only Installed In Tables 30" Wide or Wider

\*\* Bowls Are Turned with 16" Front to Back on 24" Wide Tables

† K-50 Swing Spout Faucet (Double Bowl)

#### FLAT TOP, 1" or 1-1/2" REAR SPLASH

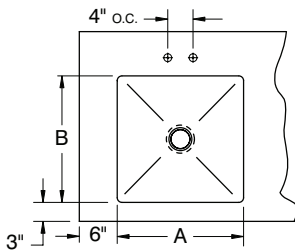

#### 5" REAR SPLASH with 1" RETURN

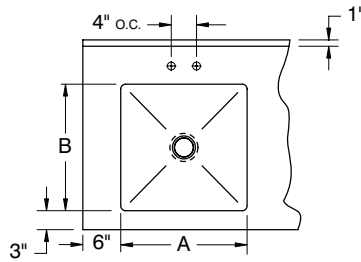

#### 10" REAR SPLASH with 2" RETURN

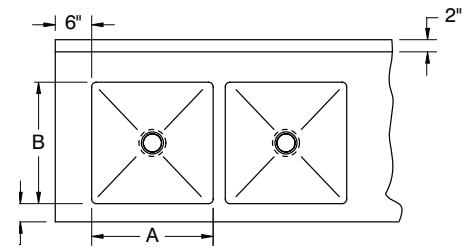

## Modifications



TA-56 \$465  
5" NSF Partition



TA-92 \$169  
Add 12" Apron  
In Front Of Sink



TA-11Z \$42/lin. ft.  
(Return Only)  
Modify 5" Splash To  
Have 2" Return For  
Splash Mounted Faucet

## Faucets & Accessories

K-2B	Poly-Vance Sink Cutting Board for 14" x 16" Bowls	\$281 ea.
K-2C	Poly-Vance Sink Cutting Board for 16" x 20" Bowls	281 ea.
K-2D	Poly-Vance Sink Cutting Board for 18" x 24" Bowls	281 ea.
K-2E	Poly-Vance Sink Cutting Board for 20" x 20" Bowls	281 ea.
K-2F	Poly-Vance Sink Cutting Board for 24" x 24" Bowls	281 ea.
K-2J	Poly-Vance Sink Cutting Board for 18" x 18" Bowls	281 ea.
K-4	Lever Drain Bracket	122
K-5	Lever Drain	265
K-12	Deck Mounted Soap Dispenser	144
K-15	Lever Drain With Overflow	469
K-50	8" Deck Mounted 4" O.C. Swing Spout Faucet	245
K-50OMIT	Omit Swing Spout	-22
K-52	3 1/2" Spout Deck Mounted 4" O.C. Gooseneck Faucet	221
K-52OMIT	Omit Swing Spout Gooseneck Faucet	-22
K-53	12" Deck Mounted 4" O.C. Swing Spout Faucet	427
K-54	8-1/4" Water Filler Faucet	468

K-54A	12" Water Filler Faucet	\$576
K-55	8 1/2" Spout 4" O.C. Deck Mounted Gooseneck Faucet	427
K-60	4" O.C. Splash Mounted Gooseneck Faucet	554
K-62	X.H.D. 4" O.C. Deck Mounted Gooseneck Faucet	439
K-105	14" Splash Mounted 8" O.C. Faucet	415
K-112	Extra Heavy Duty 12" Splash Mounted Faucets	406
K-316-LU	Wrist Handles For Splash Mounted Faucets	114
K-350	Residential Finish & Packaging	360
K-452	6" x 9" Control Bracket	267
K-453	14" x 16" Control Bracket	287
K-460	Installation Of Disposal Cone w/ 6" x 9" Control Bracket	798
K-461	Installation Of Collar w/ 6" x 9" Control Bracket	798
K-470	14" Deep Bowls	173
K-472	Faucet Hole Revision	121
DTA-100	Prerinse Basket for 20" x 20" Bowls	617
DTA-125	Prerinse Basket for 16" x 20" Bowls	538

**WARNING:** Equipment that includes a faucet may expose you to chemicals, including lead, that are known to the State of California to cause cancer or birth defects or other reproductive harm. For more Info., visit [www.p65warnings.ca.gov](http://www.p65warnings.ca.gov).

# DRAWERS

## Integral Drawer Slides

Ship Via UPS



**PATENT PENDING**

Shown With  
3 Tier Drawer Set Up

# REVOLUTIONARY NEW SHD SERIES DRAWER WITH INTEGRAL DRAWER SLIDES

- Stainless Steel Front & Sides
- Self Closing Drawer with Noise Control
- Drawer "Safety Stop" Tab
- Removable Stainless Steel Insert
- Units Can Be Stacked to Create Multiple Tier Drawers
- Hardware Included
- NSF Approved

**Drawers Stack With Ease  
To Create Tier Drawers!  
Easily Installs In Field**

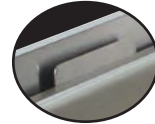

Features a  
"Safety Stop" Tab



NSF

<b>SHD-2015</b>	<b>Insert Size</b> 20" x 15" x 5" Overall Dim. 24 5/8" x 17 1/2"	<b>\$984</b>	
<b>SHD-1520</b>	15" x 20" x 5" Overall Dim. 17 1/2" x 24 5/8"	<b>\$984</b>	
<b>SHD-2020</b>	20" x 20" x 5" Overall Dim. 24 5/8" x 22 11/16"	<b>\$1051</b>	

### Optional Concealed Side Panels FOR 20"x20" DRAWERS (1 Needed For Each Side)

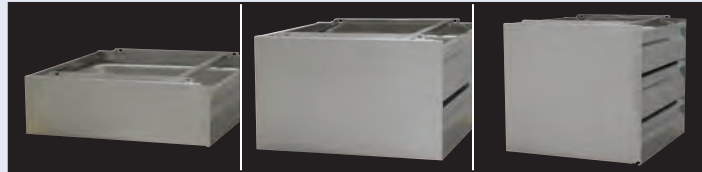

**1 Drawer:**  
TA-SHD-1  
\$153

**2 Drawers:**  
TA-SHD-2 \$192  
each side

**3 Drawers:**  
TA-SHD-3  
\$230

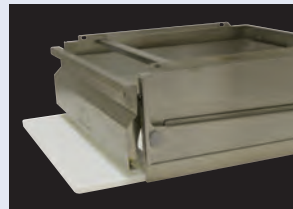

**TA-97SHD \$300**  
Poly Board Storage Bracket  
(Installs In Field. Hardware Included)



Rear View of Multiple Stacked  
Drawers. Seams Exposed

### SHD Series Modifications & Accessories

<b>TA-2</b>	Concealed Side Panel For 20" x 15" Drawer .....	<b>\$39 ea.</b>
(Add Additional Cost to TA-SHD-1, 2, or 3 Price)		
<b>TA-13</b>	Padlockable Drawer Lock .....	<b>259</b>
<b>TA-14SHD</b>	Drawer Lock For SHD Drawers.....	<b>143</b>
<b>TA-97SHD</b>	Poly Board Storage Brackets For SHD Drawers .....	<b>300</b>
<b>TA-41SHD</b>	5/8" Thick Poly Cutting Board For SHD Drawers .....	<b>146 ea.</b>

### DELUXE SERIES DRAWERS

- Stainless Steel Front
- Ball Bearing Slides
- Removable Insert

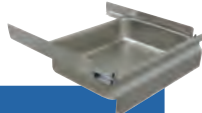

Insert Size	All Stainless Steel		All Stainless Steel with Keyed Lock		Galvanized Body	
	Model #	Price	Model #	Price	Model #	Price
20" x 15" x 5"	SS-2015	\$539	SS-2015-DL	\$667	GZ-2015	\$383
15 x 20" x 5"	SS-1520	539	SS-1520-DL	667	GZ-1520	383
20 x 20" x 5"	SS-2020	584	SS-2020-DL	712	GZ-2020	418

### BUDGET SERIES DRAWERS

- Friction Slides
- Die Formed Handle

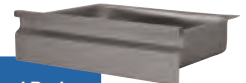

Insert Size	All Stainless Steel		Galvanized Body	
	Model #	Price	Model #	Price
20" x 15" x 5"	FS-2015	\$237	FG-2015	\$159
15" x 20" x 5"	FS-1520	237	FG-1520	159
20" x 20" x 5"	FS-2020	271	FG-2020	174

### Deluxe and Budget Drawer Accessories

#### Padlockable Drawer Lock

(Does not include lock. Fits padlocks up to 3/8" Dia. lock shaft)

**TA-13** ..... **\$259**

#### Keyed Drawer Lock (GZ Series)

**TA-14** ..... **128**

#### Drawer Adapter/Non Catalog Tables

(specify table width)

**TA-90** ..... **62**

#### Replacement Drawer Slides (FS & FG Series)

**TA-SL-15** ..... **137**

#### Replacement Drawer Slides (SS & GZ Series)

**TA-SL-20** ..... **149**



**TA-14 Drawer Lock**

## CONCEALED HAND SINK DRAWER

Take Back Your Countertop Space!



- Easily Installs into Existing Advance Tabco Work Tables/Countertops or Integrates into Custom Fabrication
- Overall Size: 22 5/8" W x 19 7/8" L x 19 1/4" H"
- 10" x 14" x 5" Deep Sink Bowl
- Pre-Drilled Holes In Flanges For Easy Mounting
- Integral Drawer Slides For Smooth Operation
- "Safety Stop" Tab
- K-50 Swing Spout Faucet
- 1-1/2" Sink Drain with Strainer Plate
- Drainage Pan with 1-1/2" Drain & Strainer Plate (Drain Pipe & Fittings Included.)

**7-PS-47 \$2600**  
70 lbs. 7 cu. ft. 18 gauge



K-50 Faucet



Drawer  
Safety Stop Tab

NSF

**All Units on this Page Feature  
the All New SHD Series Drawers!**

# DRAWERS

Integral Drawer Slides

## MOBILE DRAWER CABINETS

- Stainless Steel Top Features Countertop Edge
- 5" Swivel Plate Casters (2 with Brakes)
- Available with Three or Four Tier Drawers

Model #	Overall Size L x W x H	# Of Drawers	Drawer Size	Price
<b>MDC-2020</b>	25 1/4" x 25 3/4" x 29 1/2"	3	20" x 20" x 5"	<b>\$4055</b>
<b>MDC-4-2020</b>	25 1/4" x 25 3/4" x 29 1/2"	4	20" x 20" x 5"	<b>4940</b>
<b>MDC-2015</b>	25 1/4" x 21 3/4" x 29 1/2"	3	20" x 15" x 5"	<b>3923</b>
<b>MDC-4-2015</b>	25 1/4" x 21 3/4" x 29 1/2"	4	20" x 15" x 5"	<b>4787</b>



## FACTORY INSTALLED "SHD SERIES" TIER DRAWERS

**3 or 4 Tiers Available  
Factory Installation Only**

Model #	# Of Tiers	Inset Size	Price
<b>TA-38</b>	3 Tiers	20" x 20" x 5"	<b>\$3705</b>
<b>TA-384</b>	4 Tiers	20" x 20" x 5"	<b>4478</b>



TA-38 SHOWN

**For Tier Drawers on 24" Tables,  
Add TA-380 \$153 (Drawers will be 20" x 15" x 5")**

**New 4 Tier Unit Offers More Storage,  
Same Height as 3 Tier Units!**

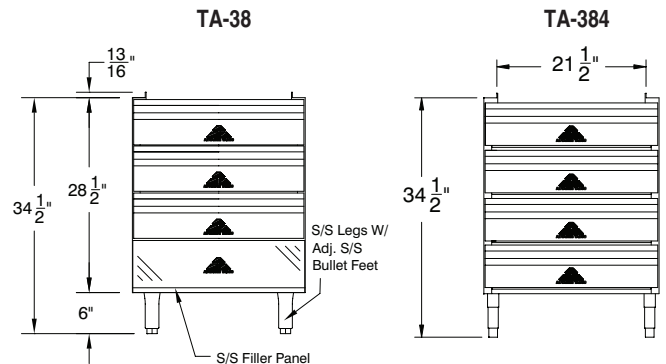

ADT-3-2020 SERIES SHOWN  
(Table Not Included)



## ADD-A-TIER DRAWERS

**Fits Under 24", 30" and 36" Wide  
Open Base Work Tables!**

**Features:**

- Units Come Fully Assembled!
- Includes 2 or 3 SHD-2020 Series Drawers Stacked with 2 TA-SHD Series Concealed Side Panels (See Photos).
- Hangs From Underside of Open Base Table with Included Hardware.

(See Page 60 for SHD Series Drawer Details)

**Includes 2 Concealed Side Panels**

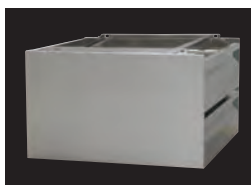

2 Drawer Concealed Panel  
Model ADT-2-2020 Shown



3 Drawer Concealed Panel  
Model ADT-3-2020 Shown



Rear View of Stacked Drawers  
Drawer Seams Exposed

Model #	Overall Size L x W x H	# Of Drawers	Drawer Size	Price
<b>ADT-2-2020</b>	23" x 23" x 14"	2	20" x 20" x 5"	<b>\$2469</b>
<b>ADT-3-2020</b>	23" x 23" x 21"	3	20" x 20" x 5"	<b>3583</b>
<b>ADT-3-2015</b>	23" x 18" x 21"	3	20" x 15" x 5"	<b>3386</b>

# CASTERS

Casters

All Casters Ship Via UPS

## WORK TABLE CASTERS



### Standard Casters

Legs Cut To Maintains Standard 35-1/2" Working Height  
200 lbs. Load Capacity Per Caster

#### When Used w/ Stainless Steel Legs

TA-25S-4 \$394/set of 4 (Two with Brakes)  
TA-25S-6 \$590/set of 6 (Two with Brakes)

#### When Used w/ Galvanized Legs

TA-25G-4 \$394/set of 4 (Two with Brakes)  
TA-25G-6 \$590/set of 6 (Two with Brakes)

### Casters For Special Height Tables (TA-33) and Open Base Tables (T Series)

TA-25 \$394/set of 4 (Two with Brakes)  
TA-25A \$590/set of 6 (Two with Brakes)

200 lbs. Load Capacity Per Caster



### Single Replacement Casters

Available With Or Without Brake (Legs Not Included)

200 lbs. Load Capacity Per Caster



TA-25R \$78 ea. (No Brake) TA-25RB \$95 ea. (With Brake)



#### Optional Standard Caster Upgrades:

TA-25B \$193/set For brakes on all wheels (Standard Casters) - Add price to the following models: TA-25, TA-25A, TA-25S-4, TA-25S-6, TA-25G-4, TA-25G-6

TA-25C \$34/Per Caster Upgrade Standard Caster with Heavy Duty Urethane Wheels (Per Caster)

## EQUIPMENT STAND CASTERS



### Standard Casters

5" Urethane Wheels.  
Maintains the Standard 24" Working Height  
200 lbs. Load Capacity Per Caster

#### w/ Stainless Steel Legs

TA-25ES \$394/set of 4 (Two with Brakes)

#### w/ Galvanized Legs

TA-25EG \$394/set of 4 (Two with Brakes)

### HEAVY DUTY Casters

5" Urethane Wheels

400 lbs. Load Capacity Per Caster



TA-255 \$539 Super Heavy Duty Set of 4 (Two with Brakes)

TA-256 714 Super Heavy Duty Set of 6 (Two with Brakes)

#### Optional Equipment Stand Caster Upgrade:

TA-255B \$264 For brakes on all wheels (Equipment Casters) - Add price to any of the following models: TA-255, TA-256, TA-25ES, TA-25EG

### Enclosed Base Table Casters Easy Bolt-On Style



TA-255P \$636 Set of 4 (Two with Brakes)

TA-255AP \$928 Set of 6 (Two with Brakes)

300 lbs. Load Capacity Per Caster

For brakes on all wheels (Enclosed Base Casters) - Add price to models: TA-255P or TA-255AP

TA-255PB \$305

## MID-SHELF & UNDERSHELVES



Shelf Capacity  
20 lbs./sq. ft.



### Stainless Steel

### Galvanized

Length	24" Wide	Price	30" Wide	Price	36" Wide	Price	24" Wide	Price	30" Wide	Price	36" Wide	Price
2'	US-24-24	\$322	US-30-24	\$365	NOT AVAILABLE		UG-24-24	\$184	UG-30-24	\$218	NOT AVAILABLE	
30"	US-24-30	365	US-30-30	402	US-36-30	\$462	UG-24-30	218	UG-30-30	223	UG-36-30	\$228
3'	US-24-36	380	US-30-36	462	US-36-36	555	UG-24-36	230	UG-30-36	228	UG-36-36	234
4'	US-24-48	429	US-30-48	521	US-36-48	592	UG-24-48	236	UG-30-48	243	UG-36-48	245
5'	US-24-60	495	US-30-60	564	US-36-60	668	UG-24-60	243	UG-30-60	251	UG-36-60	265
6'	US-24-72	559	US-30-72	641	US-36-72	788	UG-24-72	245	UG-30-72	265	UG-36-72	270
7'	US-24-84	635	US-30-84	689	US-36-84	832	UG-24-84	251	UG-30-84	270	UG-36-84	281
8'	US-24-96	689	US-30-96	785	US-36-96	907	UG-24-96	265	UG-30-96	275	UG-36-96	305
9'	US-24-108	717	US-30-108	899	US-36-108	1082	UG-24-108	275	UG-30-108	316	UG-36-108	328
10'	US-24-120	754	US-30-120	936	US-36-120	1119	UG-24-120	298	UG-30-120	337	UG-36-120	348
11'	US-24-132	939	US-30-132	1106	US-36-132	1234	UG-24-132	331	UG-30-132	363	UG-36-132	374
12'	US-24-144	966	US-30-144	1142	US-36-144	1302	UG-24-144	371	UG-30-144	404	UG-36-144	415

TA-94 \$54 lin. ft.  
16 ga. S/S 304 Series Upgrade for any shelf

TA-9 \$42 lin. ft.  
1-1/2" Turn-Up for Undershelves

**PATENT PENDING**

## MULTI-USE FOOD SHIELDS

Quickly Converts From Cafeteria Style To Self-Serve Style



### With Stainless Steel Shelf

18" Standard Shelf Height (Top of Table to Top of Shelf). 24" Wide Shelving Also Available



DSG-12S-48 Glass Positioned For Cafeteria Style



DSG-12S-48 Glass Positioned For Self-Serve Style

- Bottom front glass locks in place at 3 fixed positions
- Entire glass front rotates for easy cleaning
- Stainless Steel 1" diameter Posts.
- Includes Two 18" Wide Glass Side Panels
- 1/4" Thick Heat-Tempered Glass Side Panels
- 3/8" Thick Heat-Tempered Glass Fronts
- Stainless Steel Top Shelf (DSG "S" Series)
- 3/8" Glass Top Shelf (DSG "G" Series)

\*Requires a Single Pair of Center Legs (Factory Print Included)  
 \*\*Requires Two Pair of Center Legs (Factory Print Included)

12" WIDE	Price	Approx. Wt.	15" WIDE	Price	Approx. Wt.	18" WIDE	Price	Approx. Wt.	Approx. Cubes
DSG-12S-36	\$4367	131 lbs.	DSG-15S-36	\$4896	133 lbs.	DSG-18S-36	\$5106	136 lbs.	14
DSG-12S-48	4517	166 lbs.	DSG-15S-48	5007	169 lbs.	DSG-18S-48	5215	173 lbs.	18
DSG-12S-60	5138	191 lbs.	DSG-15S-60	5379	196 lbs.	DSG-18S-60	5588	199 lbs.	22
DSG-12S-72	5342	237 lbs.	DSG-15S-72	5652	245 lbs.	DSG-18S-72	5991	250 lbs.	26
DSG-12S-84†	5528	276 lbs.	DSG-15S-84†	5907	279 lbs.	DSG-18S-84†	6118	286 lbs.	30
DSG-12S-96†	6004	312 lbs.	DSG-15S-96†	6317	314 lbs.	DSG-18S-96†	6525	323 lbs.	34
DSG-12S-108†	6177	346 lbs.	DSG-15S-108†	6651	353 lbs.	DSG-18S-108†	6861	359 lbs.	38
DSG-12S-120†	6356	382 lbs.	DSG-15S-120†	6854	389 lbs.	DSG-18S-120†	7050	397 lbs.	42
DSG-12S-132†	6514	420 lbs.	DSG-15S-132†	7009	428 lbs.	DSG-18S-132†	7219	437 lbs.	46
DSG-12S-144††	6818	455 lbs.	DSG-15S-144††	7143	465 lbs.	DSG-18S-144††	7352	473 lbs.	50

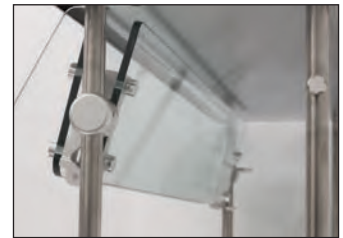

Bottom Glass Flips All The Way Up To Become A Self-Serve Unit



Bottom Glass Can be Used As a Shelf

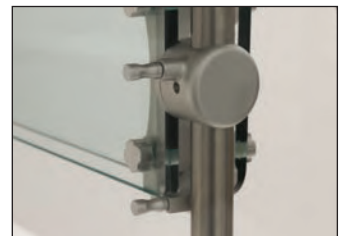

Easy To Use Mechanism For Changing Front Glass Positions



Entire Glass Shield Rotates For Easy Cleaning

### With 3/8" Glass Top

18" Standard Shelf Height (Top of Table to Top of Glass Shelf)



DSG-12G-72 Glass Positioned For Cafeteria Style



DSG-12G-72 Glass Positioned For Self-Serve Style

12" WIDE	Price	Approx. Wt.	15" WIDE	Price	Approx. Wt.	18" WIDE	Price	Approx. Wt.	Approx. Cubes
DSG-12G-36	\$5206	139 lbs.	DSG-15G-36	\$5777	143 lbs.	DSG-18G-36	\$6196	147 lbs.	18
DSG-12G-48	5355	179 lbs.	DSG-15G-48	5886	182 lbs.	DSG-18G-48	6306	187 lbs.	23
DSG-12G-60	5976	228 lbs.	DSG-15G-60	6259	235 lbs.	DSG-18G-60	6669	242 lbs.	29
DSG-12G-72	6182	279 lbs.	DSG-15G-72	6533	266 lbs.	DSG-18G-72	6954	275 lbs.	34
DSG-12G-84†	6370	298 lbs.	DSG-15G-84†	6789	305 lbs.	DSG-18G-84†	7207	316 lbs.	39
DSG-12G-96†	6843	330 lbs.	DSG-15G-96†	7196	346 lbs.	DSG-18G-96†	7616	357 lbs.	44
DSG-12G-108†	7015	373 lbs.	DSG-15G-108†	7532	383 lbs.	DSG-18G-108†	7951	397 lbs.	49
DSG-12G-120†	7195	412 lbs.	DSG-15G-120†	7721	424 lbs.	DSG-18G-120†	8141	439 lbs.	55
DSG-12G-132†	7352	453 lbs.	DSG-15G-132†	7890	467 lbs.	DSG-18G-132†	8309	483 lbs.	60
DSG-12G-144††	7656	495 lbs.	DSG-15G-144††	8023	511 lbs.	DSG-18G-144††	8467	528 lbs.	65

# FOOD SHIELDS

## Adjustable Food Shields

### Sleek Shields™

Protected By: Patent No. US 9,010,883 B2

### With Stainless Steel Shelf

18" Standard Shelf Height (Top of Table to Top of Shelf) • 24" Wide Shelving Also Available

### SELF SERVE STYLE

12" WIDE	Price	Approx. Wt.	15" WIDE	Price	Approx. Wt.	18" WIDE	Price	Approx. Wt.	Approx. Cubes
NSG-12-36	\$2912	120 lbs.	NSG-15-36	\$3179	122 lbs.	NSG-18-36	\$3849	124 lbs.	18
NSG-12-48	2993	152 lbs.	NSG-15-48	3315	155 lbs.	NSG-18-48	3986	159 lbs.	23
NSG-12-60*	3652	191 lbs.	NSG-15-60*	3688	194 lbs.	NSG-18-60*	4359	198 lbs.	29
NSG-12-72*	3779	221 lbs.	NSG-15-72*	3961	228 lbs.	NSG-18-72*	4632	230 lbs.	34
NSG-12-84†	3964	254 lbs.	NSG-15-84†	4216	260 lbs.	NSG-18-84†	4888	265 lbs.	39
NSG-12-96†	4438	288 lbs.	NSG-15-96†	4624	293 lbs.	NSG-18-96†	5294	299 lbs.	44
NSG-12-108**	4611	314 lbs.	NSG-15-108**	4957	321 lbs.	NSG-18-108**	5629	327 lbs.	49
NSG-12-120**	4790	363 lbs.	NSG-15-120**	5148	370 lbs.	NSG-18-120**	5818	376 lbs.	55
NSG-12-132**	4949	398 lbs.	NSG-15-132**	5317	406 lbs.	NSG-18-132**	5989	413 lbs.	60
NSG-12-144**	5252	422 lbs.	NSG-15-144**	5452	430 lbs.	NSG-18-144**	6124	439 lbs.	65

- †Requires a Single Pair of Center Legs (Factory Print Included)
- \*\*Requires Two Pair of Center Legs (Factory Print Included)
- \*3/8" Thick Heat-Tempered Glass Required For Front Glass

#### Exclusive Features Of NSG/NDSG/NSGC Sleek Shields:

- Front glass locks in place at 15° intervals
- Stainless Steel 1" diameter Posts
- Includes Two 1/4" Heat-Tempered Side Glass
- 1/4" or 3/8" Thick Heat-Tempered Glass Front Panels (See Chart For "\*\*" Symbol)
- Shelves have two rolled edges on front & rear and square edges on left & right sides

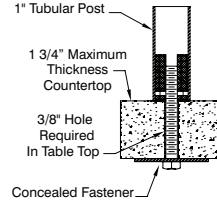

Includes Standard Concealed Mounting Hardware (Access To Underside Of Counter Required)

**Sleek Shields™ w/ Stainless Steel or Glass Shelf Can Be Added To All Hot/Cold Food Tables On Pages 123-131 See Sleek Shield Models For Food Tables On Page 136**



Shipped KD - TA-47 Mounting Brackets Included For In-Field Installation

### SELF SERVE STYLE - DOUBLE TIER

12" WIDE	Price	Approx. Wt.	15" WIDE	Price	Approx. Wt.	18" WIDE	Price	Approx. Wt.	Approx. Cubes
NDSG-12-36	\$4598	155 lbs.	NDSG-15-36	\$4800	160 lbs.	NDSG-18-36	\$5472	166 lbs.	26
NDSG-12-48	4796	194 lbs.	NDSG-15-48	4936	199 lbs.	NDSG-18-48	5606	206 lbs.	34
NDSG-12-60*	5417	243 lbs.	NDSG-15-60*	5309	250 lbs.	NDSG-18-60*	5982	258 lbs.	41
NDSG-12-72*	5622	277 lbs.	NDSG-15-72*	5582	290 lbs.	NDSG-18-72*	6255	308 lbs.	49
NDSG-12-84†	5810	324 lbs.	NDSG-15-84†	5837	330 lbs.	NDSG-18-84†	6508	344 lbs.	56
NDSG-12-96†	6284	353 lbs.	NDSG-15-96†	6245	365 lbs.	NDSG-18-96†	6917	376 lbs.	64
NDSG-12-108**	6456	399 lbs.	NDSG-15-108**	6579	405 lbs.	NDSG-18-108**	7249	411 lbs.	71
NDSG-12-120**	6637	443 lbs.	NDSG-15-120**	6771	445 lbs.	NDSG-18-120**	7441	457 lbs.	79
NDSG-12-132**	6794	483 lbs.	NDSG-15-132**	6938	496 lbs.	NDSG-18-132**	7610	503 lbs.	86
NDSG-12-144**	6881	513 lbs.	NDSG-15-144**	7073	546 lbs.	NDSG-18-144**	7835	546 lbs.	94



10-1/2" Standard Glass Opening (Maximum 13") From Table To Bottom Of Glass.

### CAFETERIA STYLE

12" WIDE	Price	Approx. Wt.	15" WIDE	Price	Approx. Wt.	18" WIDE	Price	Approx. Wt.	Approx. Wt.
NSGC-12-36	\$3249	125 lbs.	NSGC-15-36	\$3778	128 lbs.	NSGC-18-36	\$3988	130 lbs.	18
NSGC-12-48	3399	160 lbs.	NSGC-15-48	3889	163 lbs.	NSGC-18-48	4097	167 lbs.	23
NSGC-12-60*	4019	185 lbs.	NSGC-15-60*	4261	190 lbs.	NSGC-18-60*	4470	193 lbs.	29
NSGC-12-72*	4224	231 lbs.	NSGC-15-72*	4534	239 lbs.	NSGC-18-72*	4873	244 lbs.	34
NSGC-12-84†	4410	270 lbs.	NSGC-15-84†	4789	274 lbs.	NSGC-18-84†	5000	281 lbs.	39
NSGC-12-96†	4886	306 lbs.	NSGC-15-96†	5199	308 lbs.	NSGC-18-96†	5406	317 lbs.	44
NSGC-12-108**	5059	340 lbs.	NSGC-15-108**	5532	347 lbs.	NSGC-18-108**	5742	353 lbs.	49
NSGC-12-120**	5237	376 lbs.	NSGC-15-120**	5736	383 lbs.	NSGC-18-120**	5931	391 lbs.	55
NSGC-12-132**	5396	414 lbs.	NSGC-15-132**	5891	422 lbs.	NSGC-18-132**	6101	431 lbs.	60
NSGC-12-144**	5699	450 lbs.	NSGC-15-144**	6025	574 lbs.	NSGC-18-144**	6234	467 lbs.	65



1-1/2" Standard Glass Opening (Maximum 1-1/2") From Table To Bottom Of Glass.

**CUSTOM UNITS & SIZES AVAILABLE ON ALL FOOD SHIELDS**

Food Shield Prices May Change Due To Customer Specifications & Design

### With Glass Top

3/8" Thick Heat-Tempered Glass Top

<sup>†</sup>Requires a Single Pair of Center Legs (Factory Print Included)  
<sup>††</sup>Requires Two Pair of Center Legs (Factory Print Included)  
<sup>\*</sup>3/8" Thick Heat-Tempered Glass Required For Front Glass

#### Exclusive Features Of GSG/GSGC/NSGD Sleek Shields:

- Front glass locks in place at 15° intervals
- Stainless Steel 1" diameter Posts
- Includes Two 1/4" Heat-Tempered Side Glass
- 1/4" or 3/8" Thick Heat-Tempered Glass Front Panels (See Chart For "\*" Symbol)
- Glass Top Features 3/8" Heat-Tempered Glass Top

### SELF SERVE STYLE

12" WIDE	Price	Approx. Wt.	15" WIDE	Price	Approx. Wt.	18" WIDE	Price	Approx. Wt.	Approx. Cubes
GSG-12-36	\$3272	127 lbs.	GSG-15-36	\$3737	130 lbs.	GSG-18-36	\$4157	133 lbs.	18
GSG-12-48	3413	162 lbs.	GSG-15-48	3873	167 lbs.	GSG-18-48	4293	173 lbs.	23
GSG-12-60*	4044	202 lbs.	GSG-15-60*	4247	209 lbs.	GSG-18-60*	4666	216 lbs.	29
GSG-12-72 <sup>†</sup>	4169	238 lbs.	GSG-15-72 <sup>†</sup>	4520	245 lbs.	GSG-18-72 <sup>†</sup>	4940	253 lbs.	34
GSG-12-84 <sup>†</sup>	4355	274 lbs.	GSG-15-84 <sup>†</sup>	4776	282 lbs.	GSG-18-84 <sup>†</sup>	5195	292 lbs.	39
GSG-12-96 <sup>†</sup>	4831	309 lbs.	GSG-15-96 <sup>†</sup>	5182	319 lbs.	GSG-18-96 <sup>†</sup>	5603	330 lbs.	44
GSG-12-108 <sup>†*</sup>	5001	338 lbs.	GSG-15-108 <sup>†*</sup>	5518	350 lbs.	GSG-18-108 <sup>†*</sup>	5922	362 lbs.	49
GSG-12-120 <sup>†*</sup>	5181	391 lbs.	GSG-15-120 <sup>†*</sup>	5707	403 lbs.	GSG-18-120 <sup>†*</sup>	6126	417 lbs.	55
GSG-12-132 <sup>†*</sup>	5340	427 lbs.	GSG-15-132 <sup>†*</sup>	5894	442 lbs.	GSG-18-132 <sup>†*</sup>	6297	457 lbs.	60
GSG-12-144 <sup>††</sup>	5644	455 lbs.	GSG-15-144 <sup>††</sup>	6011	472 lbs.	GSG-18-144 <sup>††</sup>	6431	489 lbs.	65



10-1/2" Standard Glass Opening (Maximum 13")  
 From Table To Bottom Of Glass.  
 Max. Load For Top Glass Is 100 Lbs. Even Dist. Wt.

### CAFETERIA STYLE

12" WIDE	Price	Approx. Wt.	15" WIDE	Price	Approx. Wt.	18" WIDE	Price	Approx. Wt.	Approx. Cubes
GSGC-12-36	\$3640	133 lbs.	GSGC-15-36	\$4212	137 lbs.	GSGC-18-36	\$4631	141 lbs.	18
GSGC-12-48	3789	173 lbs.	GSGC-15-48	4321	176 lbs.	GSGC-18-48	4741	182 lbs.	23
GSGC-12-60*	4410	222 lbs.	GSGC-15-60*	4694	229 lbs.	GSGC-18-60*	5103	236 lbs.	29
GSGC-12-72 <sup>†</sup>	4617	274 lbs.	GSGC-15-72 <sup>†</sup>	4968	260 lbs.	GSGC-18-72 <sup>†</sup>	5389	269 lbs.	34
GSGC-12-84 <sup>†</sup>	4805	292 lbs.	GSGC-15-84 <sup>†</sup>	5224	300 lbs.	GSGC-18-84 <sup>†</sup>	5642	311 lbs.	39
GSGC-12-96 <sup>†</sup>	5277	330 lbs.	GSGC-15-96 <sup>†</sup>	5630	340 lbs.	GSGC-18-96 <sup>†</sup>	6050	351 lbs.	44
GSGC-12-108 <sup>†*</sup>	5450	367 lbs.	GSGC-15-108 <sup>†*</sup>	5966	377 lbs.	GSGC-18-108 <sup>†*</sup>	6385	391 lbs.	49
GSGC-12-120 <sup>†*</sup>	5629	406 lbs.	GSGC-15-120 <sup>†*</sup>	6155	419 lbs.	GSGC-18-120 <sup>†*</sup>	6575	434 lbs.	55
GSGC-12-132 <sup>†*</sup>	5787	447 lbs.	GSGC-15-132 <sup>†*</sup>	6324	461 lbs.	GSGC-18-132 <sup>†*</sup>	6743	477 lbs.	60
GSGC-12-144 <sup>††</sup>	6090	489 lbs.	GSGC-15-144 <sup>††</sup>	6458	505 lbs.	GSGC-18-144 <sup>††</sup>	6902	522 lbs.	65

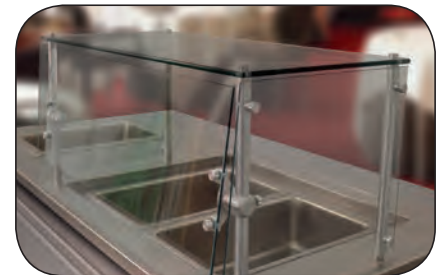

1-1/2" Standard Glass Opening (Maximum 1-1/2")  
 From Table To Bottom Of Glass.  
 Max. Load For Top Glass Is 100 Lbs. Even Dist. Wt.

### SELF SERVE STYLE - DOUBLE SIDED

w/ Stainless Steel Shelf			w/ Glass Top			
Model #	Price	Approx. Wt.	Model #	Price	Approx. Wt.	Approx. Cubes
NSGD-40-36	\$5337	339 lbs.	GSGD-40-36	\$5457	368 lbs.	32
NSGD-40-48	5480	391 lbs.	GSGD-40-48	5601	437 lbs.	42
NSGD-40-60*	6110	451 lbs.	GSGD-40-60*	6230	509 lbs.	51
NSGD-40-72 <sup>†</sup>	6234	518 lbs.	GSGD-40-72 <sup>†</sup>	6354	592 lbs.	61
NSGD-40-84 <sup>†</sup>	6422	604 lbs.	GSGD-40-84 <sup>†</sup>	6542	660 lbs.	70
NSGD-40-96 <sup>†</sup>	6896	667 lbs.	GSGD-40-96 <sup>†</sup>	7016	729 lbs.	79
NSGD-40-108 <sup>†*</sup>	7068	725 lbs.	GSGD-40-108 <sup>†*</sup>	7459	798 lbs.	89
NSGD-40-120 <sup>†*</sup>	7247	782 lbs.	GSGD-40-120 <sup>†*</sup>	7727	868 lbs.	98
NSGD-40-132 <sup>†*</sup>	7406	840 lbs.	GSGD-40-132 <sup>†*</sup>	7884	932 lbs.	107
NSGD-40-144 <sup>††</sup>	7711	909 lbs.	GSGD-40-144 <sup>††</sup>	8059	1001 lbs.	117



GSGD Series Shown  
 10-1/2" Standard Glass Opening (Maximum 13")  
 From Table To Bottom Of Glass.  
 Max. Load For Top Glass Is 100 Lbs. Even Dist. Wt.

**Sleek Shields™ w/ Stainless Steel or Glass Shelf Can Be Added To Hot/Cold Food Tables**  
 With 2, 3 or 4 Wells, Listed On Pages 123 - 131  
 See Sleek Shield Models For Food Tables On Page 136  
 Shipped KD - TA-47 Mounting Brackets Included For In-Field Installation



# FOOD SHIELDS

## Adjustable & Stationary Food Shields



For Accessories & Modifications Available - See Page 71

### Sleek Shields™ SELF SERVE FOOD SHIELD

14 3/4" Standard Front Glass  
Glass Clearance is 10" From Table to Bottom of Glass

Single Front Glass				Dual Front Glass (Includes Center Post)			
Model #	Price	Approx. Wt.	Approx. Cubes	Model #	Price	Approx. Wt.	Approx. Cubes
GS-36	\$3639	136	20	GS-72	\$4578	243	37
GS-48	3756	171	26	GS-84	4728	280	40
GS-60	3871	266	31	GS-96	5584	317	44
GS-66	4026	238	34	GS-120	5849	358	48



FEATURING  
**CHAMBER LOCK™**  
**ROTATION SYSTEM**  
Protected By: Patent No. US  
9,010,883 B2

- 3/8" Thick Heat-Tempered Glass Front
- 2 - 21 7/8" Wide x 22" High, 1/4" Thick Heat-Tempered Side Glass
- 1" Stainless Steel Tubing Posts

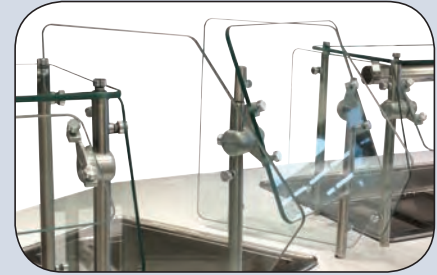

### STATIONARY FOOD SHIELDS w/ 12" WIDE GLASS TOP

Includes Front & Side Glass • 15" Wide Glass Top Also Available

- 3/8" Thick Heat-Tempered Top Glass
- 1/4" Thick Heat-Tempered Front Glass
- Two 1/4" Thick Heat-Tempered Glass Side Panels

- 1" Stainless Steel Rounded Tubing
- Includes Standard Concealed Mounting Hardware (Access To Underside Of Counter Required)

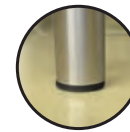

Convert Stationary Food Shields  
With Glass Top Or Angled Front  
To Be Portable **STP-1** - \$529

#### Self-Serve Style

8" Standard Front Glass Height

Model #	Price	Approx. Wt.	Approx. Cubes
STFS-12-36	\$4278	144 lbs.	6
STFS-12-48	4429	184 lbs.	8
STFS-12-60*	4789	230 lbs.	9

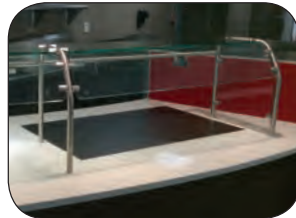

\*3/8" Thick Heat-Tempered Glass Required For Front

#### Cafeteria Style

19" Standard Front Glass Height

Model #	Price	Approx. Wt.	Approx. Cubes
STFC-12-36	\$4666	155 lbs.	6
STFC-12-48	4766	196 lbs.	8
STFC-12-60*	5151	260 lbs.	9



### 45° ANGLED FOOD SHIELDS

#### Self-Serve Style

w/ Angled Top & Side Glass

Model #	Price	Approx. Wt.	Approx. Cubes
AFS-36	\$3224	130 lbs.	6
AFS-48	3669	164 lbs.	8
AFS-60*	4025	207 lbs.	10



Shown With Black Powder Coating

- 1/4" Thick Heat-Tempered Front Glass
- 1/4" Thick Side Glass
- 1" Stainless Steel Tubing with End Caps
- Includes Standard Concealed Mounting Hardware (Access To Underside Of Counter Required)

#### Cafeteria Style

w/ Angled Top, Front & Side Glass

Model #	Price	Approx. Wt.	Approx. Cubes
AFC-36	\$3814	143 lbs.	6
AFC-48	4251	178 lbs.	8
AFC-60*	4366	235 lbs.	10



### VERTICAL FOOD SHIELDS

24" Standard Front Glass Height



- 1/4" Thick Heat-Tempered Glass
- Two 18" Wide Glass Side Panels
- 1" Stainless Steel Tubing with End Caps (1 5/8" Tubing Also Available)
- Includes Standard Concealed Mounting Hardware (Access To Underside Of Counter Required)
- NSF Requires 60" Minimum Height Above Finished Floor
- NSF Requires 6" Maximum Height From Top of Table to Bottom of Glass

Custom Food Shield Sizes Available  
Call Our Smart Fabrication™ Department At  
800-645-3166

Model #	Price	Approx. Wt.	Approx. Cubes
SGCC-36	\$4343	139 lbs.	9
SGCC-48	4797	194 lbs.	11
SGCC-60*	5406	219 lbs.	13
SGCC-72	6845	240 lbs.	15
SGCC-84	6789	271 lbs.	17
SGCC-96	7143	311 lbs.	19
SGCC-108*	7719	357 lbs.	22
SGCC-120*	8459	412 lbs.	25
SGCC-132	8991	451 lbs.	26
SGCC-144	9635	518 lbs.	27

\*3/8" Thick Heat-Tempered Glass Required For Front

For Enclosed Base Table Options See Pages 48-49



### SLEEK SHIELDS™ ACCESSORIES & MODIFICATIONS

#### LED Display Lighting

**Factory Installed**

- Aluminum Rail with Shatter-Proof Optics
- Standard Natural Aluminum Finish. Available in White or Black
- Includes Class 2 Low Voltage Power Supply-120V-277V
- High Impact Resistant Mounting Clips



**FACTORY INSTALLED ONLY**  
**Includes Installation Charge**

L	S/S Shelf Mounted		Glass Top Mounted	
	Model #	Price	Model #	Price
1'	LED-S-12	\$373	LED-G-12	\$548
2'	LED-S-24	450	LED-G-24	625
3'	LED-S-36	519	LED-G-36	691
4'	LED-S-48	579	LED-G-48	754
5'	LED-S-60	644	LED-G-60	820
6'	LED-S-72	733	LED-G-72	908

**Shelves Require 6" Clearance On Both Sides To Fit Above Led Lighting.**

**PRINT REQUIRED FOR PROPER LED LOCATION**

#### Heat Lamp Mounting Provisions

Customers To Supply Heat Lamp

**All Food Shields With Glass Tops Require Factory Installation Only**

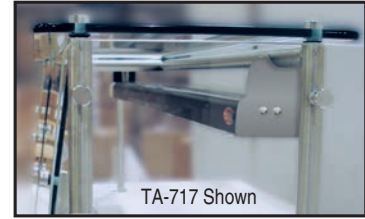

**FACTORY INSTALLED**

**TA-717 \$202 /lin. ft.**  
**MINIMUM OF 3 FEET REQUIRED. MUST ORDER SAME LENGTH AS FOOD SHIELD.**

- Welded Tubular Stainless Steel Posts
- Chase-Way for Concealing Wiring
- Pre-Wiring Available
- Print Required For Proper Installation

**INSTALLED BY OTHERS**

(Provision for mounting to Stainless Steel Shelves only)

**TA-71 \$155 ea.**

#### Revolutionary Sleek Shield™ Horizontal Swivel Bracket

- Bracket Connects Multiple Sleek Shields™ And Swivels Freely for Custom Line Up
- Easily Adjusts In Field Without Tools
- Factory Installed Only

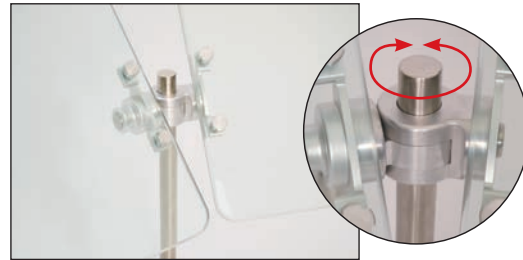

**SG-S \$1202**  
Per Section



SG-1

#### SURFACE MOUNTING BRACKET

(For 1" Posts)

**SG-1 \$111 ea.**

#### CANTILEVER SUPPORT BRACKET UPGRADE

(Omits Front or Rear Support Leg To Equipment in Counter)

**SG-C \$416 per leg**



SG-PC Shown

#### CUSTOM COLORS

**SG-AN Call For Pricing**  
Color Anodizing For Sleek Shields™ (For Aluminum Components)

**SG-PC Call For Pricing**  
Powder Coating For Sleek Shields™ (For Stainless Steel Components)

### PORTABLE FOOD SHIELDS

- 15" Front Panel
- 1/4" Thick Thermoplastic Polymer Sneeze Guard
- 1" Stainless Steel Posts
- 1-1/2" Wide x 14-1/2" Front to Back Black Support Base
- Shipped K.D.

Length	Model #	Price	Approx. Wt.	Approx. Cubes
36"	PFS-36B	\$1893	12 lbs.	14
48"	PFS-48B	2192	15 lbs.	18
60"	PFS-60B	2465	18 lbs.	21
72"	PFS-72B	2690	21 lbs.	24



#### OPTIONAL 18" WIDE SIDE PANELS

18" x 20" x 1/4" Acrylic Side Panels  
Factory Installed Only

**PFS-SP \$783 /set of 2**

Approx. 5 lbs.

# SHELVING

## Stainless Steel Shelving



Shelves Mount to Underside of Table with Single Expansion Bolt to Maximize Space

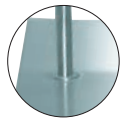

### TABLE MOUNTED ALL STAINLESS STEEL SHELVING

#### Single Deck



#### SINGLE DECK SHELVING

Ft.	12" WIDE	Price	15" WIDE†	Price	Approx. Wt.	Approx. Cubes
3'	OTS-12-36	\$721	OTS-15-36	\$863	24 lbs.	2
4'	OTS-12-48	758	OTS-15-48	935	25 lbs.	3
5'	OTS-12-60	822	OTS-15-60	1055	31 lbs.	3
6'	OTS-12-72	875	OTS-15-72	1167	37 lbs.	4
7'	OTS-12-84	935	OTS-15-84	1222	43 lbs.	5
8'	OTS-12-96*	1130	OTS-15-96*	1316	50 lbs.	5
9'	OTS-12-108*	1201	OTS-15-108*	1566	59 lbs.	6
10'	OTS-12-120*	1232	OTS-15-120*	1605	68 lbs.	7
11'	OTS-12-132*	1297	OTS-15-132*	1798	82 lbs.	7
12'	OTS-12-144*	1335	OTS-15-144*	1839	98 lbs.	8

\* SHELVES 8' OR LONGER INCLUDE CENTER LEG SUPPORT

Check It Out  
Post Height can be customized!  
Use TA-33A \$48

#### DOUBLE DECK SHELVING

12" WIDE	Price	15" WIDE†	Price	Approx. Wt.	Approx. Cubes
ODS-12-36	\$1436	ODS-15-36	\$1552	24 lbs.	4
ODS-12-48	1476	ODS-15-48	1672	29 lbs.	5
ODS-12-60	1573	ODS-15-60	1876	35 lbs.	6
ODS-12-72	1678	ODS-15-72	2058	40 lbs.	7
ODS-12-84	1797	ODS-15-84	2231	46 lbs.	8
ODS-12-96*	2143	ODS-15-96*	2496	55 lbs.	10
ODS-12-108*	2308	ODS-15-108*	2716	60 lbs.	11
ODS-12-120*	2348	ODS-15-120*	2825	66 lbs.	12
ODS-12-132*	2508	ODS-15-132*	2979	72 lbs.	13
ODS-12-144*	2546	ODS-15-144*	3111	78 lbs.	14

\*8' or longer includes center leg support

For 1" Rear Turn Up, add "R" after model # (Example: OTS-12-60R) • †15" Wide Shelving has 1-5/8" Tubing

For 10" Wide Shelving – Use 12" Models & Price. Replace "12" with "10" (Example: ODS-10-36)

### TABLE MOUNTED FULLY ADJUSTABLE SHELVING WITH 14" OR 30" CHROME POSTS

#### SINGLE DECK SHELVING

Ft.	12" WIDE	Price	Approx. Wt.	Approx. Cubes
3'	TS-12-36	\$676	13 lbs.	2
4'	TS-12-48	717	15 lbs.	3
5'	TS-12-60	767	17 lbs.	3
6'	TS-12-72	819	20 lbs.	4
7'	TS-12-84	873	23 lbs.	5
8'	TS-12-96*	1066	28 lbs.	5
9'	TS-12-108*	1133	30 lbs.	6
10'	TS-12-120*	1171	33 lbs.	7
11'	TS-12-132*	1240	36 lbs.	7
12'	TS-12-144*	1280	39 lbs.	8

#### DOUBLE DECK SHELVING

Ft.	12" WIDE	Price	Approx. Wt.	Approx. Cubes
3'	DS-12-36	\$1331	24 lbs.	4
4'	DS-12-48	1371	29 lbs.	5
5'	DS-12-60	1477	35 lbs.	6
6'	DS-12-72	1582	40 lbs.	7
7'	DS-12-84	1687	46 lbs.	8
8'	DS-12-96*	2046	55 lbs.	10
9'	DS-12-108*	2218	60 lbs.	11
10'	DS-12-120*	2260	66 lbs.	12
11'	DS-12-132*	2429	72 lbs.	13
12'	DS-12-144*	2465	78 lbs.	14

\*8' or longer includes center leg support

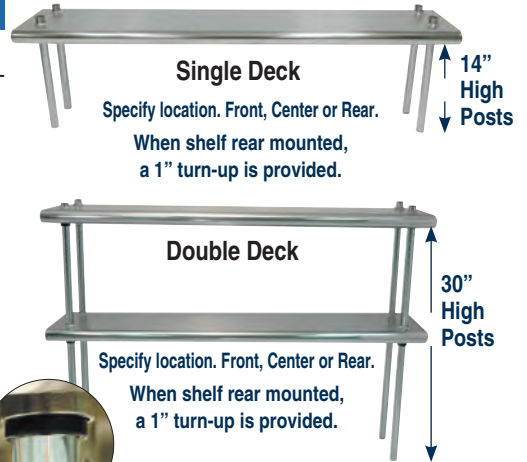

For 10" Wide Shelving  
Use 12" Models & Price.  
Replace "12" with "10" (Example: DS-10-36)

Tapered Split Sleeve Installation & Numbered Posts



For 1" Rear Turn Up, add "R" after model # (Example: TS-12-60R) • For 15" Wide Shelving (w/ 1-5/8" Tubing) Use OTS/ODS Series

### ADJUSTABLE 18" WIDE DOUBLE OVERSHELF WITH 6" OFFSET



Length	Model #	Price	Approx. Wt.	Approx. Cubes
3'	CDS-18-36	\$2532	24 lbs.	4
4'	CDS-18-48	2582	29 lbs.	5
5'	CDS-18-60	2906	35 lbs.	6
6'	CDS-18-72	2968	40 lbs.	7
7'	CDS-18-84	3032	46 lbs.	8
8'	CDS-18-96	3197	55 lbs.	10
9'	CDS-18-108	3387	60 lbs.	11
10'	CDS-18-120	3440	66 lbs.	12
11'	CDS-18-132	3578	72 lbs.	13
12'	CDS-18-144	3616	78 lbs.	14

# 18" & 24" WIDE TABLE MOUNTED SHELVING



# SHELVING Specialty Shelving

## For Existing Equipment For SMART FABRICATION™ CHEF'S LINE

- Stainless Steel Shelving (1 Tier or 2 Tier Shelves)
- Stainless Steel Posts (1" Posts Available)
- Mounting Brackets Included

Customer To Specify Models Of Buyout Equipment.  
Print Required.

### Call For a Custom Quote

Quote Prints Available On Request  
- A Service Only Advance Tabco Offers!  
Call Our Estimating Department At 800-645-3166  
or email smartFab@advancetabco.com

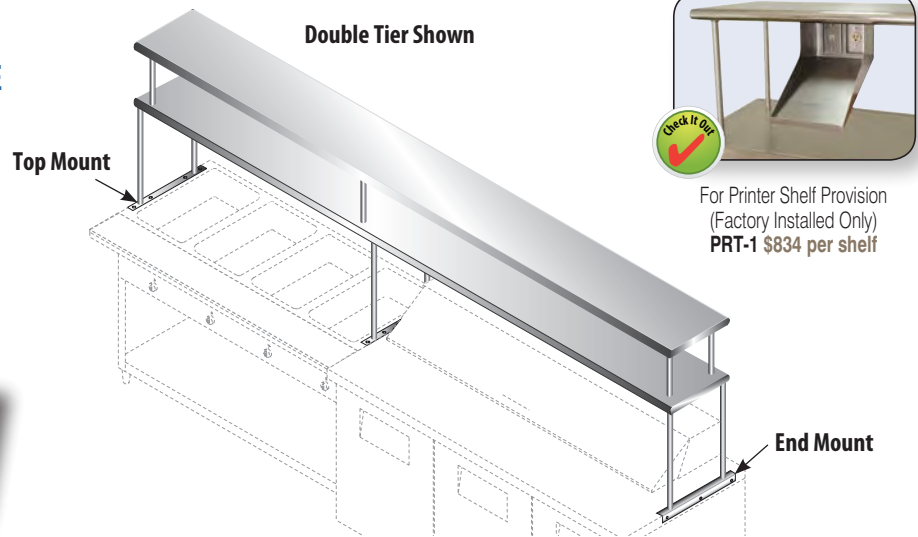

### Single Tier Shelving

Ft.	Approx. Cubes	18" WIDE			24" WIDE		
		Price	Approx. Wt.	Price	Approx. Wt.		
4'	12	CU-18-48	\$1471	42 lbs.	CU-24-48	\$1819	55 lbs.
5'	15	CU-18-60	1519	53 lbs.	CU-24-60	1949	61 lbs.
6'	17	CU-18-72	1575	64 lbs.	CU-24-72	2034	70 lbs.
7'	20	CU-18-84	1785	75 lbs.	CU-24-84	2317	81 lbs.
8'	23	CU-18-96	1923	89 lbs.	CU-24-96	2494	98 lbs.
9'	26	CU-18-108	2074	95 lbs.	CU-24-108	2752	104 lbs.
10'	29	CU-18-120	2195	105 lbs.	CU-24-120	2963	113 lbs.
11'	32	CU-18-132	2315	118 lbs.	CU-24-132	3032	129 lbs.
12'	35	CU-18-144	2390	130 lbs.	CU-24-144	3373	146 lbs.

### Double Tier Shelving

Ft.	Approx. Cubes	18" WIDE			24" WIDE		
		Price	Approx. Wt.	Price	Approx. Wt.		
4'	12	CU-18-48-2	\$2832	76 lbs.	CU-24-48-2	\$3116	114 lbs.
5'	15	CU-18-60-2	2967	95 lbs.	CU-24-60-2	3264	131 lbs.
6'	17	CU-18-72-2	3103	115 lbs.	CU-24-72-2	3413	152 lbs.
7'	20	CU-18-84-2	3368	135 lbs.	CU-24-84-2	3707	176 lbs.
8'	23	CU-18-96-2	3492	160 lbs.	CU-24-96-2	3842	207 lbs.
9'	26	CU-18-108-2	3647	121 lbs.	CU-24-108-2	3896	239 lbs.
10'	29	CU-18-120-2	3704	189 lbs.	CU-24-120-2	3955	283 lbs.
11'	32	CU-18-132-2	3703	212 lbs.	CU-24-132-2	4073	331 lbs.
12'	35	CU-18-144-2	3872	235 lbs.	CU-24-144-2	4261	387 lbs.

## Shelving Modifications

### Undermount Paper/Accessories Shelf

TA-117 \$263 /lin. ft.

#### Additional Fixed Partitions

(Specify Location For Factory Installation) TA-117A \$103 ea.

- 7" Wide x 12" High
- Two Adjustable Partitions To Create Separate Compartments

FACTORY INSTALLED ONLY

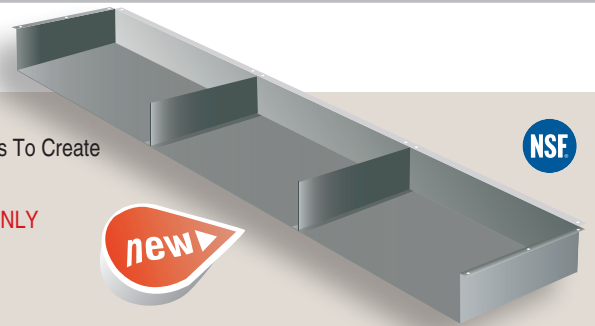

TA-9A	Partial 1" Turn-Up for all Table Mt. Shelves .....	\$42 /lin. ft.	TA-71	Heat Lamp Mounting Provision .....	\$155 ea.
TA-22A	Square Edge on Overshelf .....	98 ea.	TA-71A	Heat Lamp Remote Control Bracket.....	305 ea.
TA-26-10	Welded Wall Shelf Brackets for 10" Shelf.....	244 /shelf	TA-77	Check Minder Shelf Provision (Factory Install Only) .....	56 /lin. ft.
TA-26-12	Welded Wall Shelf Brackets for 12" Shelf.....	244 /shelf	TA-85	30" Wide CU Shelf (Add to price of 24" Shelf. For double tier, add twice) .....	197 /lin. ft.
TA-26-15	Welded Wall Shelf Brackets for 15" Shelf.....	244 /shelf	TA-99	16 Ga. S/S 304 Upgrade for Wall & Over Shelves .....	25 /lin. ft.
TA-26-18	Welded Wall Shelf Brackets for 18" Shelf.....	244 /shelf	TA-99A	14 Ga. S/S 304 Upgrade for Wall & Over Shelves .....	45 /lin. ft.
TA-33A	Customize Post Height (Specify Height) .....	48 /Shelf	TA-100A	Bull Nose Edge On all 4 Sides of Shelf .....	98 ea.
TA-47	Shelf Mounting Bracket for Existing Table .....	89 /shelf	TA-102	24" x 24" Extension for Microwave or Computer Shelf (Add to OTS and ODS Shelves. See page 45) .....	406 ea.
TA-49	Wall Shelf 2" Offset .....	172 /shelf	TA-103	24" Wide PT Shelf (36" Min Length. Mid mount only. PT Series Shelf, see pg. 48. Add to 18" Wide Shelf) .....	121 /lin. ft.
TA-60	Special Sizing Charge for Shelves (Must Order Larger Unit to be Cut Down to Smaller Size) .....	N/C	TA-104	Add'l Length Over 12' - Add to 18" or 24" Shelf (CU Shelving Only. Maximum Length is 14' as Single Piece) .....	261 /lin. ft.
TA-62	Duplex Electrical Outlet (Under Flat Top) .....	435 ea.			
TA-62D	GFI Duplex Outlet in a Doghouse Box .....	487 ea.			

# SHELVING

## Specialty Shelving

**NSF** All Pass-thru Shelving on this Page

 = Ship Via UPS

## PASS-THRU SHELVING

### Standard Pass-Thru Shelf

- "Hat Channel" Design Allows Shelf To Be Freely Positioned
- Includes Wall Mounting Brackets For Securing Shelf To Desired Position



Pass-Thru shown with Cantilever Brackets



### Pass-Thru Shelf with Overshelf



- 1 CU Series Overshelf welded to a PA Series Pass-Thru shelf
- 1-5/8" Stainless Steel Tubing
- Shipped as Welded Set-Up



Pass-Thru with CU Series Shelf & Cantilever Bracket Shown

**Pre-Wiring Available!**  
 Contact our **Smart Fab Department** at [smartfab@advancetabco.com](mailto:smartfab@advancetabco.com)

18" WIDE	Price	24" WIDE	Price	# of Length Brackets	
 PA-18-24	\$985	PA-24-24	\$1108	24"	2
 PA-18-36	1209	PA-24-36	1216	36"	2
 PA-18-48	1316	PA-24-48	1643	48"	2
PA-18-60	1416	PA-24-60	1769	60"	2
PA-18-72	1466	PA-24-72	1894	72"	2
PA-18-84	1516	PA-24-84	2072	84"	3
PA-18-96	1570	PA-24-96	2217	96"	3
PA-18-108	1636	PA-24-108	2229	108"	3
PA-18-120	1667	PA-24-120	2258	120"	3
PA-18-132	1819	PA-24-132	2465	132"	4
PA-18-144	2072	PA-24-144	2645	144"	4

18" WIDE	Price	24" WIDE	Price	# of Length Brackets	
 PA-18-48-2	\$2704	PA-24-48-2	\$3415	48"	2
 PA-18-60-2	2853	PA-24-60-2	3666	60"	2
PA-18-72-2	2954	PA-24-72-2	3873	72"	2
PA-18-84-2	3204	PA-24-84-2	4330	84"	3
PA-18-96-2	3392	PA-24-96-2	4646	96"	3
PA-18-108-2	3600	PA-24-108-2	4915	108"	3
PA-18-120-2	3749	PA-24-120-2	5157	120"	3
PA-18-132-2	4013	PA-24-132-2	5426	132"	4
PA-18-144-2	4332	PA-24-144-2	5940	144"	4

#### Mounting Brackets Included

With Pass-Thru Shelving



**\*2" x 4" - L Bracket**  
For 18" Wide Shelves



**\*\*5" x 5" - Cantilever Bracket**  
For 24" Wide Shelves

### PASS-THRU MODIFICATION

Includes Side & Top • Minimum Length = 36"

#### Pass-Thru Frame

Length	Model	Price
36"	TA-84F-36	\$1214
48"	TA-84F-48	1347
60"	TA-84F-60	1484
72"	TA-84F-72	1588
84"	TA-84F-84	1670



**Print Required For Proper Location**

## Electrical Utility Chases

**Call For Wiring Installation!**



FLOOR CHASE



CEILING CHASE

- Conceals Wires
- Removable Panel For Wire Access.
- Wiring Available Upon Request.

Available only for CU Series & OTS Series Shelving (Pages 68-69)

MODEL	FEED TYPE	PRICE
UCC-1	Ceiling	\$1605
UCF-1	Floor	1418

**Print required for proper chase location.**  
Utility Chase is **FACTORY INSTALLATION** only.

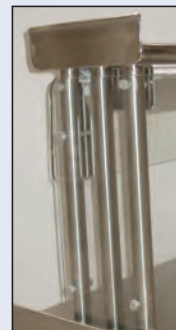

PIPE CHASE

- Conceals Wires For Heat Lamps.
- Required Installation Of Buyout Equipment

Consult Factory for Wiring

MODEL	PRICE
PC-1	\$630 ea.



Brackets Can Be Positioned To Accommodate Wall Studs



# SHELVING

## Wall Mounted Shelving

- 1 1/2" Rolled Rim With A 1 1/2" Turn-Up At Rear Ends Are Turned Down Square

### 16 GA. WALL MOUNTED SHELVING

304 Type Stainless Steel

Length	10" WIDE	Price	12" WIDE	Price	15" WIDE	Price	18" WIDE	Price	Approx. Wt.	Approx. Cubes
2'	WS-10-24-16	\$339	WS-12-24-16	\$349	WS-15-24-16	\$573	WS-18-24-16	\$795	10 lbs.	3
30"	-	-	WS-12-30-16	399	-	-	-	-	11 lbs.	3
3'	WS-10-36-16	364	WS-12-36-16	401	WS-15-36-16	609	WS-18-36-16	831	12 lbs.	4
42"	-	-	WS-12-42-16	450	-	-	-	-	13 lbs.	5
4'	WS-10-48-16	383	WS-12-48-16	452	WS-15-48-16	647	WS-18-48-16	868	14 lbs.	5
5'	WS-10-60-16	427	WS-12-60-16	495	WS-15-60-16	739	WS-18-60-16	961	17 lbs.	6
6'	WS-10-72-16	459	WS-12-72-16	527	WS-15-72-16	839	WS-18-72-16	1054	19 lbs.	7
7'	WS-10-84-16	525	WS-12-84-16	583	WS-15-84-16	901	WS-18-84-16	1107	22 lbs.	8
8'	WS-10-96-16	601	WS-12-96-16	638	WS-15-96-16	1042	WS-18-96-16	1152	26 lbs.	10
9'	WS-10-108-16	659	WS-12-108-16	693	WS-15-108-16	1120	WS-18-108-16	1246	28 lbs.	11
10'	WS-10-120-16	744	WS-12-120-16	790	WS-15-120-16	1152	WS-18-120-16	1385	31 lbs.	12
11'	WS-10-132-16	734	WS-12-132-16	830	WS-15-132-16	1321	WS-18-132-16	1439	35 lbs.	13
12'	WS-10-144-16	792	WS-12-144-16	852	WS-15-144-16	1405	WS-18-144-16	1490	38 lbs.	14

### 18 GA. WALL MOUNTED SHELVING

430 Type Stainless Steel

Length	10" WIDE	Price	12" WIDE	Price	15" WIDE	Price	18" WIDE	Price	Approx. Wt.	Approx. Cubes
2'	WS-10-24	\$270	WS-12-24	\$279	WS-15-24	\$323	WS-18-24	\$586	10 lbs.	3
30"	-	-	WS-12-30	317	-	-	-	-	12 lbs.	4
3'	WS-10-36	287	WS-12-36	319	WS-15-36	365	WS-18-36	616	12 lbs.	4
42"	-	-	WS-12-42	358	-	-	-	-	14 lbs.	5
4'	WS-10-48	306	WS-12-48	360	WS-15-48	412	WS-18-48	698	14 lbs.	5
5'	WS-10-60	355	WS-12-60	395	WS-15-60	439	WS-18-60	725	17 lbs.	6
6'	WS-10-72	385	WS-12-72	423	WS-15-72	475	WS-18-72	790	19 lbs.	7
7'	WS-10-84	418	WS-12-84	466	WS-15-84	487	WS-18-84	864	22 lbs.	8
8'	WS-10-96	484	WS-12-96	510	WS-15-96	564	WS-18-96	914	26 lbs.	10
9'	WS-10-108	502	WS-12-108	555	WS-15-108	753	WS-18-108	1064	28 lbs.	11
10'	WS-10-120	599	WS-12-120	632	WS-15-120	774	WS-18-120	1107	31 lbs.	12
11'	WS-10-132	617	WS-12-132	664	WS-15-132	885	WS-18-132	1163	35 lbs.	13
12'	WS-10-144	643	WS-12-144	681	WS-15-144	936	WS-18-144	1217	38 lbs.	14

- TA-22A Square Edge Shelf \$98 ea.
- TA-26-10 Weld Support Brackets To Wall Shelf For 10" Deep Wall Shelves 244 ea.
- TA-26-12 Weld Support Brackets To Wall Shelf For 12" Deep Wall Shelves 244 ea.
- TA-26-15 Weld Support Brackets To Wall Shelf For 15" Deep Wall Shelves 244 ea.
- TA-26-18 Weld Support Brackets To Wall Shelf For 18" Deep Wall Shelves 244 ea.
- TA-49 2" Wall Shelf Offset 172 /shelf

- TA-60 Special Sizing Charge For Shelves (Must Order Larger Unit To Be Cut Down To Smaller Size)
- TA-71 Heat Lamp Mounting Provision
- TA-77 Check Minder Provision On Any Shelf
- TA-99A 14 Ga. S/S 304 Upgrade For Wall & Over Shelves
- TA-100A Bullnose Edge On All 4 Sides Of Shelf

- N/C
- 155 ea.
- 56 /lin. ft.
- 45 /lin. ft.
- 98 ea.

### K.D. WALL SHELVES

Length	STAINLESS STEEL w/ Stainless Steel Brackets		ALUMINUM w/ Aluminum Brackets		Approx. Wt.	Approx. Cubes
	Model #	Price	Model #	Price		
2'	WS-KD-24	\$238	AWS-KD-24	\$195	10 lbs.	2
3'	WS-KD-36	248	AWS-KD-36	210	12 lbs.	3
4'	WS-KD-48	274	AWS-KD-48	234	14 lbs.	4
5'	WS-KD-60	309	AWS-KD-60	251	17 lbs.	5



Width Of Shelf Is 11-1/8"

Single Shipping Container Can Be Shipped U.P.S.



Custom Sizes are Available. Contact Our SMART FABRICATION™ Department. 800-645-3166

# SHELVING

## Wall Mounted Shelving



### Slotted Cook Line Wall Shelf



- Heavy Duty
- 304 Type Stainless Steel
- 21" Wide
- 1 1/2" Square Tubes
- 1 1/4" Spacing
- Tubular Support Brackets (Shipped Loose To Suit Wall Stud Location)

**TA-26-21 \$327 per shelf**  
Optional Factory Welded Shelf Brackets (Print Required)

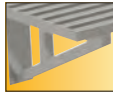

L	Model #	Price	# of Brackets	Approx. Wt.	Approx. Cubes
48"	DT21-4	\$3501	2	90 lbs.	6
72"	DT21-6	5251	3	105 lbs.	8
96"	DT21-8	7001	3	145 lbs.	10
120"	DT21-10	8752	4	190 lbs.	13
144"	DT21-12	10501	4	210 lbs.	15

**NOTE: Recommend Field Welding Brackets To Underside Of Cook Line Shelf**

### Built-In Check Minder



Floating Ball Mechanism  
Quickly Grabs Checks And Holds Them In Place

L	12" WIDE	Price	Approx. Wt.	Approx. Cubes
3'	WS-12-36CM	\$375	15 lbs.	4
4'	WS-12-48CM	416	19 lbs.	5
5'	WS-12-60CM	449	21 lbs.	6
6'	WS-12-72CM	479	25 lbs.	7
8'	WS-12-96CM	566	32 lbs.	10

## WALL SHELVES

### Under Mounted Multi-Purpose Shelf



- Heavy Duty
- Mounts below shelving or table top
- Supplied with mounting holes.
- 1 stationary divider included 36" lengths & under
- 2 stationary dividers included over 36" lengths

Model #	Price	Approx. Wt.
TA-117	\$263 lin. ft.	22 lbs. per sq. ft.

**TA-117A \$103 ea.**  
Additional Dividers

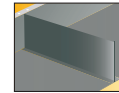

**FACTORY INSTALLED ONLY**

### with Built-In Pot Rack

Length	12" WIDE	Price	15" WIDE	Price	18" WIDE	Price	# of Hooks	Approx. Wt.	Approx. Cubes
3'	PS-12-36	\$762	PS-15-36	\$920	PS-18-36	\$1170	6	30 lbs.	5
4'	PS-12-48	803	PS-15-48	966	PS-18-48	1252	6	40 lbs.	6
5'	PS-12-60	838	PS-15-60	992	PS-18-60	1278	9	50 lbs.	7
6'	PS-12-72	866	PS-15-72	1028	PS-18-72	1344	9	60 lbs.	8
7'	PS-12-84	909	PS-15-84	1042	PS-18-84	1418	9	70 lbs.	10
8'	PS-12-96	953	PS-15-96	1117	PS-18-96	1468	9	80 lbs.	11
9'	PS-12-108	999	PS-15-108	1307	PS-18-108	1617	9	90 lbs.	12
10'	PS-12-120	1075	PS-15-120	1328	PS-18-120	1660	9	100 lbs.	13
11'	PS-12-132	1107	PS-15-132	1439	PS-18-132	1717	9	110 lbs.	14
12'	PS-12-144	1125	PS-15-144	1490	PS-18-144	1771	9	120 lbs.	26

- TA-60 Special Sizing Charge for Wall Shelves
- TA-99 16 ga. 304 Upgrade for Wall and Over Shelves
- TA-99A 14 Ga. S/S 304 Upgrade for Wall & Over Shelves

**N/C - Add to next longer shelf \$25 / lin. ft.**  
**45/lin. ft.**



**FOR CHECK MINDER PROVISION**  
On Any Shelf Use

**TA-77 \$56/lin. ft.**



### Wall Shelf w/Multipurpose Undershell



Shown with Microwave Units (Not Included)

- 5 1/2" Undershell
- Upper & Lower Grommet Holes



Size W x L	Model #	Price	Approx. Wt.	Approx. Cubes
24" x 24"	MS-24-24-PS	\$1390	58 lbs.	11
24" x 36"	MS-24-36-PS	1626	85 lbs.	16
24" x 48"	MS-24-48-PS	1863	110 lbs.	21

### Microwave Shelf

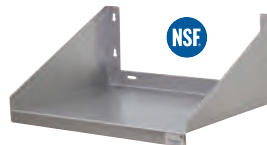

Size W x L	Model #	Price	Approx. Wt.	Approx. Cubes
18" x 24"	MS-18-24	\$531	27 lbs.	5
24" x 24"	MS-24-24	603	32 lbs.	5
24" x 36"	MS-24-36	839	38 lbs.	7
20" x 30"	MS-20-30	776	36 lbs.	5

**TA-108 \$137**  
2" Hole with Grommet For Appliance Cord.  
(Please Specify Hole Size And Location)



### 8" Wide Utility Shelf

Length	Model #	Price	Approx. Wt.	Approx. Cubes
24"	K-245	\$752	50 lbs.	1
36"	K-246	854	55 lbs.	2

## STAINLESS STEEL WALL FLASHING

Wall Flashing supplied in 10' Lengths.

- Available in 16 Gauge, 18 Gauge and 20 Gauge
- Type 304 Stainless Steel
- Polished to a Commercial Grade #3 Finish

Model #	Description	Price
WF16	16 Gauge	\$54 /sq. ft.
WF18	18 Gauge	44 /sq. ft.
WF20	20 Gauge	41 /sq. ft.







### OPTIONAL WALL FLASHING ACCESSORIES

Model #	Description	Price
WF-SC-1	Seam Cap	\$100 ea.
WF-EC-1	Edge Cap	100 ea.
WF-IC-1	Inside Corner	111 ea.









## Single Shelf

 = Ship Via UPS

Length	Model #	Price	Approx. Wt.	Approx. Cubes
3'	 CM-18-36	\$2570	24 lbs.	4
4'	 CM-18-48	2756	29 lbs.	5
5'	 CM-18-60	2938	35 lbs.	6
6'	 CM-18-72	3122	40 lbs.	7
7'	 CM-18-84	3127	46 lbs.	8
8'	 CM-18-96	3207	51 lbs.	9

## Double Shelves

Length	Model #	Price	Approx. Wt.	Approx. Cubes
3'	 DCM-18-36	\$3304	55 lbs.	5
4'	 DCM-18-48	3856	60 lbs.	6
5'	 DCM-18-60	4039	66 lbs.	7
6'	 DCM-18-72	4592	72 lbs.	8
7'	 DCM-18-84	4656	78 lbs.	9
8'	 DCM-18-96	4809	84 lbs.	10

- Stainless Steel
- 1 5/8" Stainless Steel Posts
- Shipped KD
- Load Capacity is 5 lbs. per sq. ft. (Evenly Distributed)

**CUSTOMER MUST SPECIFY CEILING HEIGHT**

# SHELVING

## Shelving & Modifications

### 18" WIDE CEILING MOUNTED SHELVING

SINGLE



DOUBLE



## SHELVING MODIFICATIONS

FACTORY INSTALLED ONLY

### Printer Shelf

- Heavy gauge stainless steel
- 8"x16" Printer Deck
- 10" height
- 1 Data Port Receptacle
- 1 Electrical Receptacle
- Rear Gem Box with Removable Enclosure
- Turned up front edge to hold Printer in place



**PRT-1 \$834 /shelf**

Back of Shelf Shown

### Check Minder



- Extruded Anodized Aluminum
- Holds checks with ease
- Floating ball mechanism quickly grabs checks & holds them in place
- Mounts to any shelf

**TA-77 \$56 /lin. ft.**

**TA-77A \$39 /lin. ft.**

Concealer for Heat Lamp. (Requires a TA-77)

### Microwave Shelf Extension



24" Front to Back  
1-5/8" Posts

Use the full length of OTS Shelves found on page 66 and then add **TA-102 \$406** extension. Specify Right or Left.

### Table Mounted Equipment Shelf



1-5/8" Posts

L	Model #	Price	Approx. Wt.	Approx. Cubes
2'	<b>MST-24-24</b>	\$1100	32 lbs.	1
3'	<b>MST-24-36</b>	1286	38 lbs.	2

### 6" Shelf Offset



- Posts located towards rear shelf
- Provides shelf reach
- Available for 18" or Wider shelving Only (CU Series Shelving)





**TA-120 \$122 /Per level**

## Accessories

### Check Minder Accessory



- Holds Checks With Ease
- Floating Ball Mechanism Quickly Grabs Checks & Holds Them In Place
- Mounts To Existing Wall Or Shelf

Length	Model #	Price	Approx. Wt.
2'	 CM-24	\$41	1.5 lbs.
3'	 CM-36	54	2.25 lbs.
4'	 CM-48	69	3 lbs.
5'	 CM-60	81	4.25 lbs.

### Wall Cap



- 16 ga., 304 Stainless Steel
- 2" x Wall Thickness x 2" x Height



Model #	Price
 <b>WALLCAP</b>	\$54 Lin. ft.

**MUST SPECIFY:**  
Wall thickness (maximum 6")  
Height (Maximum of 10 feet)  
Minimum charge 4 linear feet

### Bumper Guards









- 16 ga., 304 Stainless Steel
- Bracket Included

Model #	Size	Price
 <b>BG-48</b>	2" x 4" x 48"	\$203
 <b>BG-60</b>	2" x 4" x 60"	274

### Corner Guards



- 16 ga., 304 Stainless Steel
- Adhesive Tape Backing

Model #	Size	Price
<b>2" x 2"</b>		
 <b>CG-48</b>	2" x 2" x 48"	\$137
 <b>CG-60</b>	2" x 2" x 60"	181
 <b>CG-72</b>	2" x 2" x 72"	202
 <b>CG-84</b>	2" x 2" x 84"	238
 <b>CG-96</b>	2" x 2" x 96"	248
 <b>CG-120</b>	2" x 2" x 120"	282
<b>4" x 4"</b>		
 <b>OCG-48-SS</b>	4" x 4" x 48"	260

# POT RACKS

## Adjustable Pot Rack Components



**#1** HOW TO ORDER  
Select from 3 Mounting Provisions

*Mid, Rear or Splash*

**#2** Choose Desired Components

**NOT ONLY STURDY BUT ADJUSTABLE!**

TABLE with POT RACK, SHELVING & UTENSIL RACK  
MID MOUNT DESIGN



MIX & MATCH to Maximize Your Work Area. Components are Adjustable. You set the Height to Meet Your Demanding Requirement.

### SPECIFY MOUNTING PROVISION

FOR MID MOUNT  
Add TA-228 N/C



FOR REAR MOUNT  
ADD TA-229 N/C



FOR SPLASH MOUNT  
ADD TA-227 N/C



### Pot Racks (Includes Utensil Rack)

### Utensil Racks

Length	Model #	# of Pot Hooks	Price	Approx. Wt.	Approx. Cubes	Model #	# of Pot Hooks	Price	Approx. Wt.	Approx. Cubes
36"	SCT-36	12	\$1387	30	5	AUR-36	6	\$524	30	2
48"	SCT-48	12	1439	34	6	AUR-48	6	532	34	3
60"	SCT-60	18	1478	37	7	AUR-60	9	570	37	3
72"	SCT-72	18	2036	46	9	AUR-72	9	597	46	4
84"	SCT-84	18	2086	50	10	AUR-84	9	700	50	5
96"	SCT-96	18	2228	55	12	AUR-96	9	767	55	5
108"	SCT-108	18	2712	60	13	AUR-108	9	963	60	6
120"	SCT-120	18	2939	65	15	AUR-120	9	1022	65	7
132"	SCT-132	18	3020	68	16	AUR-132	9	1156	68	7
144"	SCT-144	18	3079	72	18	AUR-144	9	1285	72	8
36"	SWT-36	12	1103	30	5	AUR-36	6	524	30	2
48"	SWT-48	12	1130	34	6	AUR-48	6	532	34	3
60"	SWT-60	18	1143	37	7	AUR-60	9	570	37	3
72"	SWT-72	18	1156	46	9	AUR-72	9	597	46	4
84"	SWT-84	18	1387	50	10	AUR-84	9	700	50	5
96"	SWT-96	18	1411	55	12	AUR-96	9	767	55	5
108"	SWT-108	18	1677	60	13	AUR-108	9	963	60	6
120"	SWT-120	18	1696	65	15	AUR-120	9	1022	65	7
132"	SWT-132	18	1736	68	16	AUR-132	9	1156	68	7
144"	SWT-144	18	1776	72	18	AUR-144	9	1285	72	8
36"	SWT-36	12	1103	30	5	AUR-36	6	524	30	2
48"	SWT-48	12	1130	34	6	AUR-48	6	532	34	3
60"	SWT-60	18	1143	37	7	AUR-60	9	570	37	3
72"	SWT-72	18	1156	46	9	AUR-72	9	597	46	4
84"	SWT-84	18	1387	50	10	AUR-84	9	700	50	5
96"	SWT-96	18	1411	55	12	AUR-96	9	767	55	5
108"	SWT-108	18	1677	60	13	AUR-108	9	963	60	6
120"	SWT-120	18	1696	65	15	AUR-120	9	1022	65	7
132"	SWT-132	18	1736	68	16	AUR-132	9	1156	68	7
144"	SWT-144	18	1776	72	18	AUR-144	9	1285	72	8

Pot Racks 8' Or Longer, Include Center Leg Support



# SHELVING

## Adjustable Shelving Components

### Convert Your Table into an Effective Work Station



ADD - CHANGE - MODIFY with Components to Meet the Demanding Prep-Requirements of an Upgrading or Changing Food Service Environment

### Adjustable Shelves

Length	10" WIDE	Price	12" WIDE	Price	15" WIDE	Price	18" WIDE	Price	Approx. Wt.	Approx. Cubes
36"	PT-10-36	\$463	PT-12-36	\$485	PT-15-36	\$838	PT-18-36	\$1006	30	2
48"	PT-10-48	496	PT-12-48	518	PT-15-48	893	PT-18-48	1053	34	3
60"	PT-10-60	521	PT-12-60	555	PT-15-60	941	PT-18-60	1132	37	3
72"	PT-10-72	545	PT-12-72	586	PT-15-72	1089	PT-18-72	1232	46	4
84"	PT-10-84	570	PT-12-84	616	PT-15-84	1128	PT-18-84	1289	50	5
96"	PT-10-96	650	PT-12-96	694	PT-15-96	1181	PT-18-96	1368	55	5
108"	PT-10-108	1042	PT-12-108	1113	PT-15-108	1356	PT-18-108	1516	60	6
120"	PT-10-120	1146	PT-12-120	1206	PT-15-120	1497	PT-18-120	1635	65	7
132"	PT-10-132	1227	PT-12-132	1308	PT-15-132	1615	PT-18-132	1790	68	7
144"	PT-10-144	1314	PT-12-144	1374	PT-15-144	1780	PT-18-144	1913	72	8
36"	PT-10R-36	545	PT-12R-36	567	PT-15R-36	915	PT-18R-36	1034	30	2
48"	PT-10R-48	571	PT-12R-48	605	PT-15R-48	959	PT-18R-48	1110	34	3
60"	PT-10R-60	605	PT-12R-60	643	PT-15R-60	1013	PT-18R-60	1219	37	3
72"	PT-10R-72	638	PT-12R-72	681	PT-15R-72	1131	PT-18R-72	1314	46	4
84"	PT-10R-84	671	PT-12R-84	722	PT-15R-84	1203	PT-18R-84	1366	50	5
96"	PT-10R-96	756	PT-12R-96	814	PT-15R-96	1318	PT-18R-96	1510	55	5
108"	PT-10R-108	1248	PT-12R-108	1353	PT-15R-108	1510	PT-18R-108	1640	60	6
120"	PT-10R-120	1347	PT-12R-120	1507	PT-15R-120	1597	PT-18R-120	1717	65	7
132"	PT-10R-132	1450	PT-12R-132	1631	PT-15R-132	1764	PT-18R-132	1915	68	7
144"	PT-10R-144	1545	PT-12R-144	1708	PT-15R-144	1910	PT-18R-144	2036	72	8
36"	PT-10S-36	696	PT-12S-36	722	PT-15S-36	1064	PT-18S-36	1245	30	2
48"	PT-10S-48	732	PT-12S-48	761	PT-15S-48	1128	PT-18S-48	1339	34	3
60"	PT-10S-60	761	PT-12S-60	795	PT-15S-60	1177	PT-18S-60	1374	37	3
72"	PT-10S-72	792	PT-12S-72	839	PT-15S-72	1272	PT-18S-72	1449	46	4
84"	PT-10S-84	828	PT-12S-84	877	PT-15S-84	1386	PT-18S-84	1623	50	5
96"	PT-10S-96	930	PT-12S-96	986	PT-15S-96	1482	PT-18S-96	1687	55	5
108"	PT-10S-108	1497	PT-12S-108	1618	PT-15S-108	1760	PT-18S-108	1887	60	6
120"	PT-10S-120	1605	PT-12S-120	1706	PT-15S-120	1830	PT-18S-120	2020	65	7
132"	PT-10S-132	1689	PT-12S-132	1801	PT-15S-132	1929	PT-18S-132	2113	68	7
144"	PT-10S-144	1771	PT-12S-144	1833	PT-15S-144	2015	PT-18S-144	2217	72	8

Shelves 8' Or Longer, Include Center Leg Support

# POT RACKS

## Additional Pot Racks

### WALL MOUNTED POT RACKS

Includes Pot Hooks

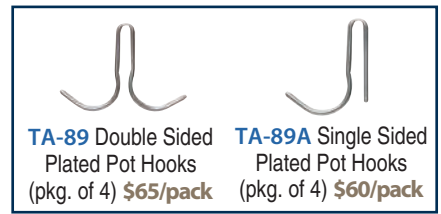

Length	Stainless Steel		Powder Coated		# Of Hooks	Wt.	Aluminum		# Of Hooks	Wt.	Cu.
	Model #	Price	Model #	Price			Model #	Price			
2'	NOT AVAILABLE						ALW-24	\$320	6	5 lbs.	1.0
3'	SW1-36	\$600	GW1-36	\$316	6	13 lbs.	ALW-36	395	6	6 lbs.	1.5
4'	SW1-48	617	GW1-48	352	6	15 lbs.	ALW-48	431	6	7 lbs.	2.0
5'	SW1-60	635	GW1-60	389	9	17 lbs.	NOT AVAILABLE				
6'	SW1-72	655	GW1-72	403	9	19 lbs.					
7'	SW1-84	671	GW1-84	421	9	21 lbs.					
8'	SW1-96	738	GW1-96	459	9	23 lbs.					
9'	SW1-108	812	GW1-108	478	9	25 lbs.					
10'	SW1-120	883	GW1-120	495	9	27 lbs.					

### Single Bar



SW1-36 Shown



GW1-36 Shown

Length	Stainless Steel		Powder Coated		# Of Hooks	Wt.	Cu.
	Model #	Price	Model #	Price			
2'	SW-24	\$830	GW-24	\$562	12	18 lbs.	4
3'	SW-36	900	GW-36	638	12	22 lbs.	5
4'	SW-48	930	GW-48	668	12	26 lbs.	6
5'	SW-60	1000	GW-60	699	18	30 lbs.	7
6'	SW-72	1050	GW-72	717	18	34 lbs.	9
7'	SW-84	1159	GW-84	776	18	44 lbs.	10
8'	SW-96	1203	GW-96	794	18	48 lbs.	12
9'	SW-108	1422	GW-108	1000	18	52 lbs.	13
10'	SW-120	1556	GW-120	1156	18	56 lbs.	15
11'	SW-132	1688	GW-132	1285	18	60 lbs.	16
12'	SW-144	1785	GW-144	1316	18	64 lbs.	18

### Double Bar



SW-36 Shown

### CEILING MOUNTED POT RACKS

Hangs 36" From Ceiling • Includes Pot Hooks



Length	Stainless Steel		Powder Coated		# Of Hooks	Wt.	Cu.
	Model #	Price	Model #	Price			
3'	SC-36	\$1544	GC-36	\$963	12	42 lbs.	5
4'	SC-48	1573	GC-48	974	12	48 lbs.	6
5'	SC-60	1639	GC-60	994	18	54 lbs.	7
6'	SC-72	1710	GC-72	1021	18	60 lbs.	9
7'	SC-84	1908	GC-84	1263	18	66 lbs.	10
8'	SC-96	2158	GC-96	1395	18	80 lbs.	12
9'	SC-108	2406	GC-108	1751	18	86 lbs.	13
10'	SC-120	2693	GC-120	1933	18	92 lbs.	15
11'	SC-132	2839	GC-132	2054	18	98 lbs.	16
12'	SC-144	3151	GC-144	2245	18	104 lbs.	18

TA-98 Stainless Steel Flat Bar in lieu of Chain \$296/pot rack

### LEG MOUNTED POT RACK

For 30" Wide Tables

Includes 6 Pot Hooks Per Unit



Stainless Steel

UB-30

\$394

Wt. 10 lbs.

For Adjustable Pot Rack Components  
See Page 79

# DISHTABLE STANDARDS



Shown with 8" Deep Sink Bowl, Pre-rinse Basket & Slide Bar

## Features and Benefits

- 3/4" Radius Corner Sink Bowls
- 10 1/2" Tile Edge Backsplash
- 1 5/8" Tubular Legs
- Economical Savings
- Satin Finish

## SPEC-LINE "30" Series

- 14 ga. 304 Stainless Steel Top
- Stainless Steel Cross Bracing on Sides
- 16 ga. 304 Stainless Steel Legs & Adjust. Bullet Feet
- 10 1/2" Backsplash
- 8" Deep Sink Bowls (Soil Units)



## STANDARD "70" Series

- 16 ga. 304 Stainless Steel Top
- Stainless Steel Cross Bracing on Sides
- Stainless Steel Legs and Adjust. Bullet Feet
- 10 1/2" Backsplash
- 5" Deep Sink Bowls (Soil Units)



## SUPERSAVER "60" Series

- 16 ga. 304 Stainless Steel Top
- Galvanized Legs & Adjust. Plastic Bullet Feet
- 10 1/2" Backsplash
- 5" Deep Sink Bowls (Soil Units)



**WHEN PLACING AN ORDER, PLEASE PROVIDE THE DISH MACHINE MODEL NUMBER TO ENSURE PROPER DISHTABLE COMPATIBILITY.**

**Due to some machine manufacturer's recommendations for specific service access, the following modifications will apply...**

### **DTA-76 (Relocate sink location)**

**Dish Machines that require a DTA-76:**

ES-4400, ES-6600, WH-series, APEX TSC-V  
CMA 180 (Right-side), 44, 66  
Hobart AM-15 (corner configuration) C-series, CL-series,  
CCS-66/77/86/110, CRS-series  
Jackson AJ-series, TS-series, TSC-series  
Meiko K-series  
Stero SCT-series

**DTA-76: No Charge**

### **DTA-78 (Notch in backsplash to clear handle)**

**Dish Machines that require a DTA-78:**

ADS HT-25, SS-25  
Blakeslee D-8, D-9  
Ecolab ES-4000  
Electrolux WT65  
Hobart AM-15 (Corner Configuration)  
**DTA-78: \$145**

# Soil Dishtables



**! ATTENTION:**  
See Dish Machine Information on Pg. 81 to ensure proper compatibility

## STRAIGHT SOIL DISHTABLES

**Spec-Line S30 Series**      **Standard S70 Series**      **Super Saver S60 Series**  
**14 Ga.**      **16 Ga.**      **16 Ga. w/ Galvanized Legs**

Nominal Size	Length	Model #	Price	Model #	Price	Model #	Price	Approx. Weight	Approx. Cu. Ft.
3 Ft.	35"	DTS-S30-36LorR	\$3385	DTS-S70-36LorR	\$2854	DTS-S60-36LorR	\$2717	70 lbs.	12
4 Ft.	47"	DTS-S30-48LorR	3548	DTS-S70-48LorR	2949	DTS-S60-48LorR	2815	85 lbs.	17
5 Ft.	59"	DTS-S30-60LorR	3629	DTS-S70-60LorR	3048	DTS-S60-60LorR	2913	100 lbs.	19
6 Ft.	71"	DTS-S30-72LorR	3770	DTS-S70-72LorR	3204	DTS-S60-72LorR	3069	115 lbs.	23
7 Ft.	83"	DTS-S30-84LorR	3880	DTS-S70-84LorR	3438	DTS-S60-84LorR	3242	125 lbs.	27
8 Ft.	95"	DTS-S30-96LorR	3934	DTS-S70-96LorR	3649	DTS-S60-96LorR	3297	135 lbs.	31
9 Ft.	107"	DTS-S30-108LorR	4673	DTS-S70-108LorR	3924	DTS-S60-108LorR	3762	235 lbs.	45
10 Ft.	119"	DTS-S30-120LorR	5000	DTS-S70-120LorR	4314	DTS-S60-120LorR	4121	290 lbs.	50
12 Ft.	143"	DTS-S30-144LorR	5787	DTS-S70-144LorR	4728	DTS-S60-144LorR	4535	320 lbs.	60

Faucet Holes are Splash Mounted 8" O.C.

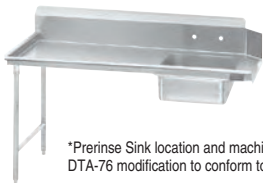

\*Pre-rinse Sink location and machine opening may require DTA-76 modification to conform to Dishmachine requirements.

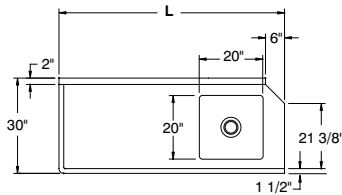

LEFT SOIL TABLE

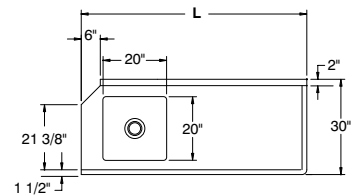

RIGHT SOIL TABLE



## CORNER SOIL DISHTABLES

**Spec-Line K30 Series**      **Standard K70 Series**      **Super Saver K60 Series**  
**14 Ga.**      **16 Ga.**      **16 Ga. w/ Galvanized Legs**

Nominal Size	Length	Model #	Price	Model #	Price	Model #	Price	Approx. Weight	Approx. Cu. Ft.
4 Ft.	47"	DTS-K30-48LorR	\$6219	DTS-K70-48LorR	\$5685	DTS-K60-48LorR	\$5434	128 lbs.	29
5 Ft.	59"	DTS-K30-60LorR	6367	DTS-K70-60LorR	5777	DTS-K60-60LorR	5559	138 lbs.	37
6 Ft.	71"	DTS-K30-72LorR	6479	DTS-K70-72LorR	5921	DTS-K60-72LorR	5714	149 lbs.	44
7 Ft.	83"	DTS-K30-84LorR	6659	DTS-K70-84LorR	6053	DTS-K60-84LorR	5893	163 lbs.	51
8 Ft.	95"	DTS-K30-96LorR	6770	DTS-K70-96LorR	6203	DTS-K60-96LorR	5954	182 lbs.	58
9 Ft.	107"	DTS-K30-108LorR	7017	DTS-K70-108LorR	6521	DTS-K60-108LorR	6215	355 lbs.	83
10 Ft.	119"	DTS-K30-120LorR	7357	DTS-K70-120LorR	7084	DTS-K60-120LorR	6356	380 lbs.	92
12 Ft.	143"	DTS-K30-144LorR	8128	DTS-K70-144LorR	7489	DTS-K60-144LorR	7310	390 lbs.	110

Faucet Holes are Splash Mounted 8" O.C.



\*Pre-rinse Sink location and machine opening may require DTA-76 modification to conform to Dishmachine requirements.

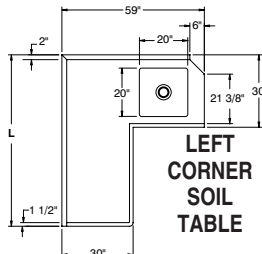

LEFT CORNER SOIL TABLE

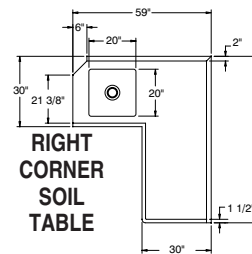

RIGHT CORNER SOIL TABLE

**! ATTENTION:**

See Dish Machine Information on Pg. 81 to ensure proper compatibility



# DISHTABLES

## Soil Dishtables

### ISLAND SOIL DISHTABLES

**Spec-Line G30 Series**

**Standard G70 Series**

**Super Saver G60 Series**

14 Ga.

16 Ga.

16 Ga. w/ Galvanized Legs

Nominal Size	Length	Model #	Price	Model #	Price	Model #	Price	Approx. Weight	Approx. Cu. Ft.
4 Ft.	47"	DTS-G30-48LorR	\$5823	DTS-G70-48LorR	\$5333	DTS-G60-48LorR	\$5100	129 lbs.	29
5 Ft.	59"	DTS-G30-60LorR	5955	DTS-G70-60LorR	5430	DTS-G60-60LorR	5217	138 lbs.	37
6 Ft.	71"	DTS-G30-72LorR	6109	DTS-G70-72LorR	5559	DTS-G60-72LorR	5372	150 lbs.	44
7 Ft.	83"	DTS-G30-84LorR	6240	DTS-G70-84LorR	5723	DTS-G60-84LorR	5545	162 lbs.	51
8 Ft.	95"	DTS-G30-96LorR	6348	DTS-G70-96LorR	5841	DTS-G60-96LorR	5600	178 lbs.	58
9 Ft.	107"	DTS-G30-108LorR	6513	DTS-G70-108LorR	6123	DTS-G60-108LorR	6011	335 lbs.	83
10 Ft.	119"	DTS-G30-120LorR	6786	DTS-G70-120LorR	6645	DTS-G60-120LorR	6521	365 lbs.	92
12 Ft.	143"	DTS-G30-144LorR	7155	DTS-G70-144LorR	7013	DTS-G60-144LorR	6900	380 lbs.	110



\*Prerinse Sink location and machine opening may require DTA-76 modification to conform to Dishmachine requirements.

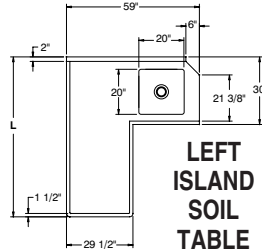

**LEFT ISLAND SOIL TABLE**

Faucet Holes are Splash Mounted 8" O.C.

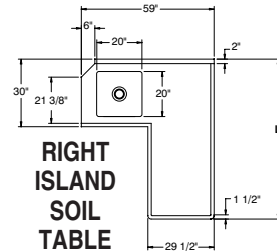

**RIGHT ISLAND SOIL TABLE**

### DISHLANDING SOIL DISHTABLES

**Spec-Line D30 Series**

**Standard D70 Series**

**Super Saver D60 Series**

14 Ga.

16 Ga.

16 Ga. w/ Galvanized Legs

Nominal Size	Length	Model #	Price	Model #	Price	Model #	Price	Approx. Weight	Approx. Cu. Ft.
4 Ft.	47"	DTS-D30-48LorR	\$6972	DTS-D70-48LorR	\$6351	DTS-D60-48LorR	\$6217	139 lbs.	33
5 Ft.	59"	DTS-D30-60LorR	7118	DTS-D70-60LorR	6481	DTS-D60-60LorR	6381	147 lbs.	41
6 Ft.	71"	DTS-D30-72LorR	7305	DTS-D70-72LorR	6627	DTS-D60-72LorR	6506	160 lbs.	50
7 Ft.	83"	DTS-D30-84LorR	7529	DTS-D70-84LorR	6773	DTS-D60-84LorR	6654	175 lbs.	58
8 Ft.	95"	DTS-D30-96LorR	7581	DTS-D70-96LorR	6926	DTS-D60-96LorR	6774	205 lbs.	66
9 Ft.	107"	DTS-D30-108LorR	7940	DTS-D70-108LorR	7080	DTS-D60-108LorR	6934	320 lbs.	93
10 Ft.	119"	DTS-D30-120LorR	8259	DTS-D70-120LorR	7491	DTS-D60-120LorR	7310	365 lbs.	103
12 Ft.	143"	DTS-D30-144LorR	8621	DTS-D70-144LorR	7813	DTS-D60-144LorR	7671	390 lbs.	123



\*Prerinse Sink location and machine opening may require DTA-76 modification to conform to Dishmachine requirements.

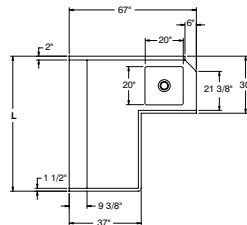

**LEFT DISHLANDING SOIL TABLE**

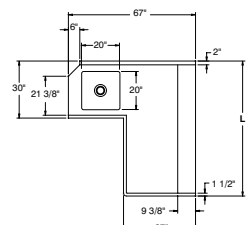

**RIGHT DISHLANDING SOIL TABLE**

# DISHTABLES

## Clean Dishtables

**! ATTENTION:**  
See Dish Machine Information on  
Pg. 81 to ensure proper compatibility

### STRAIGHT CLEAN DISHTABLES

**Spec-Line** S30 Series

**Standard** S70 Series

**Super Saver** S60 Series

14 Ga.

16 Ga.

16 Ga. w/ Galvanized Legs

Nominal Size	Length	Model #	Price	Model #	Price	Model #	Price	Approx. Weight	Approx. Cu. Ft.
2 Ft.	23"	DTC-S30-24LorR	\$1670	DTC-S70-24LorR	\$1579	DTC-S60-24LorR	\$1437	35 lbs.	12
3 Ft.	35"	DTC-S30-36LorR	2025	DTC-S70-36LorR	1812	DTC-S60-36LorR	1671	45 lbs.	12
4 Ft.	47"	DTC-S30-48LorR	2120	DTC-S70-48LorR	1973	DTC-S60-48LorR	1832	60 lbs.	17
5 Ft.	59"	DTC-S30-60LorR	2259	DTC-S70-60LorR	2090	DTC-S60-60LorR	1948	70 lbs.	19
6 Ft.	71"	DTC-S30-72LorR	2384	DTC-S70-72LorR	2191	DTC-S60-72LorR	2050	85 lbs.	23
7 Ft.	83"	DTC-S30-84LorR	2893	DTC-S70-84LorR	2434	DTC-S60-84LorR	2235	100 lbs.	27
8 Ft.	95"	DTC-S30-96LorR	3028	DTC-S70-96LorR	2640	DTC-S60-96LorR	2290	110 lbs.	31
9 Ft.	107"	DTC-S30-108LorR	3367	DTC-S70-108LorR	2977	DTC-S60-108LorR	2808	225 lbs.	45
10 Ft.	119"	DTC-S30-120LorR	3500	DTC-S70-120LorR	3208	DTC-S60-120LorR	3012	250 lbs.	50
12 Ft.	143"	DTC-S30-144LorR	3848	DTC-S70-144LorR	3512	DTC-S60-144LorR	3309	270 lbs.	60



**NSF**  
Optional  
Undershelf

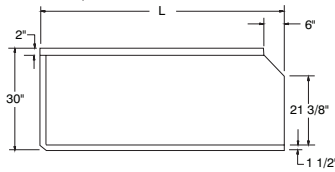

LEFT CLEAN TABLE

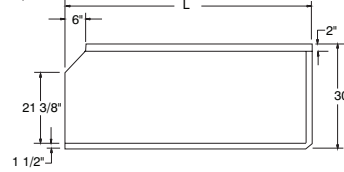

RIGHT CLEAN TABLE

### CORNER CLEAN DISHTABLES

**Spec-Line** K30 Series

**Standard** K70 Series

**Super Saver** K60 Series

14 Ga.

16 Ga.

16 Ga. w/ Galvanized Legs

Nominal Size	Length	Model #	Price	Model #	Price	Model #	Price	Approx. Weight	Approx. Cu. Ft.
4 Ft.	47"	DTC-K30-48LorR	\$4472	DTC-K70-48LorR	\$4157	DTC-K60-48LorR	\$3902	105 lbs.	29
5 Ft.	59"	DTC-K30-60LorR	4599	DTC-K70-60LorR	4272	DTC-K60-60LorR	4004	115 lbs.	37
6 Ft.	71"	DTC-K30-72LorR	4797	DTC-K70-72LorR	4584	DTC-K60-72LorR	4182	125 lbs.	44
7 Ft.	83"	DTC-K30-84LorR	5023	DTC-K70-84LorR	4761	DTC-K60-84LorR	4362	138 lbs.	51
8 Ft.	95"	DTC-K30-96LorR	5076	DTC-K70-96LorR	4820	DTC-K60-96LorR	4416	157 lbs.	58
9 Ft.	107"	DTC-K30-108LorR	6293	DTC-K70-108LorR	5954	DTC-K60-108LorR	5612	330 lbs.	83
10 Ft.	119"	DTC-K30-120LorR	6593	DTC-K70-120LorR	6228	DTC-K60-120LorR	5826	360 lbs.	92
12 Ft.	143"	DTC-K30-144LorR	7251	DTC-K70-144LorR	6810	DTC-K60-144LorR	6410	380 lbs.	110



**NSF**

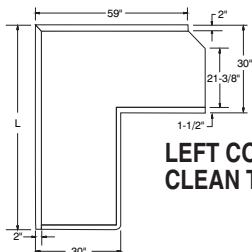

LEFT CORNER  
CLEAN TABLE

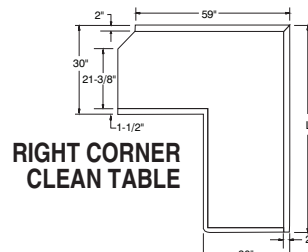

RIGHT CORNER  
CLEAN TABLE



**ATTENTION:**  
See Dish Machine Information on  
Pg. 81 to ensure proper compatibility

# DISHTABLES

## Clean Dishtables

### ISLAND CLEAN DISHTABLES

Spec-Line G30 Series

Standard G70 Series

Super Saver G60 Series

14 Ga.

16 Ga.

16 Ga. w/ Galvanized Legs

Nominal Size	Length	Model #	Price	Model #	Price	Model #	Price	Approx. Weight	Approx. Cu. Ft.
4 Ft.	47"	DTC-G30-48LorR	\$4346	DTC-G70-48LorR	\$3921	DTC-G60-48LorR	\$3771	102 lbs.	29
5 Ft.	59"	DTC-G30-60LorR	4474	DTC-G70-60LorR	4086	DTC-G60-60LorR	3879	112 lbs.	37
6 Ft.	71"	DTC-G30-72LorR	4671	DTC-G70-72LorR	4184	DTC-G60-72LorR	4052	125 lbs.	44
7 Ft.	83"	DTC-G30-84LorR	4890	DTC-G70-84LorR	4370	DTC-G60-84LorR	4232	135 lbs.	51
8 Ft.	95"	DTC-G30-96LorR	4947	DTC-G70-96LorR	4432	DTC-G60-96LorR	4287	148 lbs.	58
9 Ft.	107"	DTC-G30-108LorR	6124	DTC-G70-108LorR	5457	DTC-G60-108LorR	5274	310 lbs.	83
10 Ft.	119"	DTC-G30-120LorR	6340	DTC-G70-120LorR	5837	DTC-G60-120LorR	5571	340 lbs.	92
12 Ft.	143"	DTC-G30-144LorR	6974	DTC-G70-144LorR	6537	DTC-G60-144LorR	6137	360 lbs.	110

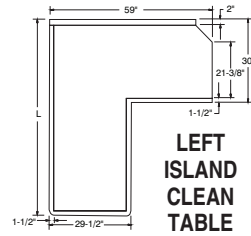

LEFT ISLAND CLEAN TABLE

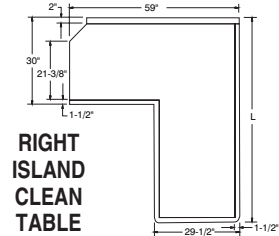

RIGHT ISLAND CLEAN TABLE

### U-SHAPED SOIL DISHTABLES

Nominal Size	Length	Model #	Price	Approx. Weight	Approx. Cu. Ft.
6 Ft.	71"	DTS-U30-72LorR	\$11247	450 lbs.	99
7 Ft.	83"	DTS-U30-84LorR	11463	470 lbs.	114
8 Ft.	95"	DTS-U30-96LorR*	11902	490 lbs.	130
9 Ft.	107"	DTS-U30-108LorR*	12209	525 lbs.	145
10 Ft.	119"	DTS-U30-120LorR*	12519	550 lbs.	160
11 Ft.	131"	DTS-U30-132LorR*	12717	575 lbs.	176
12 Ft.	143"	DTS-U30-144LorR*	12934	lbs. 600	192

\*Includes Field Joint (To be welded in field by others)

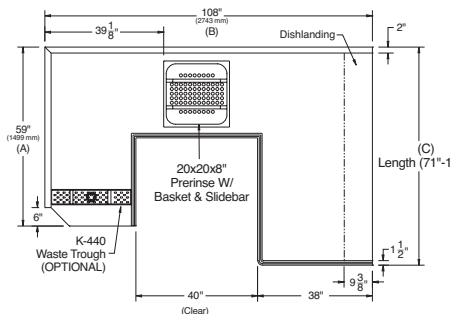

- Includes Prerinse sink basket and bar slide and dishlanding.
  - Additional length on any leg of dishtables, use **DTA-56** \$206 per ft. (Field joint may be required)
  - Additional custom lengths available on all sides.
  - If any 2 sides are larger than 90°, a welded field joint is required (WELDED BY OTHERS). USE **K-57** \$267.
  - For additional accessories and modifications, see pages 86-88.
- Dishlanding may be replaced with backsplash or rolled edge at no additional charge.*

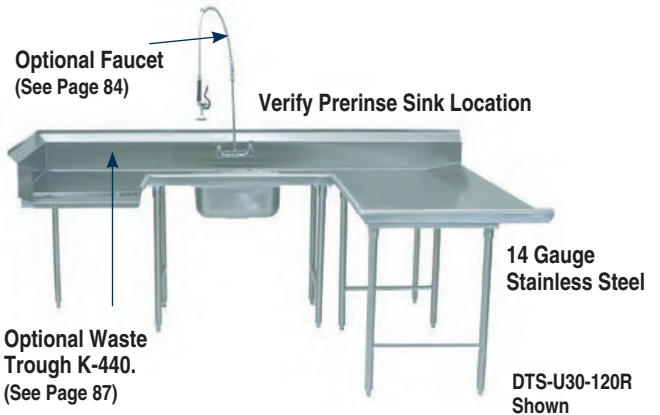

#### Prerinse Basket with Welded Slide Bar

All Stainless Steel  
Type 304 Series  
Perforated Basket for  
3/4" Radius Bowls

Model #	Size	Price
<b>DTA-100</b>	19 1/2" x 19 1/2"	<b>\$617</b>
	12 lbs. 1 Cu. Ft.	



4" Depth

#### Prerinse Slide Bar

Model #	Size	Price
<b>DTA-60</b>	19 1/2" x 19 1/2"	<b>\$354</b>
	9 lbs. 1 Cu. Ft.	

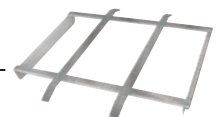

# DISHTABLES

## Specialty Dishtables

Faucets Can Be Found  
On Page 84

**! ATTENTION:**  
See Dish Machine Information on  
Pg. 81 to ensure proper compatibility

## DISHTABLE WITH 3 COMPARTMENT FABRICATED BOWLS



Multiple Bowl Choices & Lengths

- 16 Gauge Stainless Steel
- Stainless Steel Legs and Cross Rails
- Stainless Steel Bullet Feet

Model #	Length	Bowl Size	Drainboard Size	Approx. Weight	Price
<a href="#">DTC-3-1620-84LorR</a>	83"	16" x 20" x 12"	23"	220 lbs.	<b>\$7049</b>
<a href="#">DTC-3-1620-96LorR</a>	95"	16" x 20" x 12"	35"	240 lbs.	<b>7366</b>
<a href="#">DTC-3-1620-120LorR</a>	119"	16" x 20" x 12"	59"	265 lbs.	<b>7416</b>
<a href="#">DTC-3-1620-144LorR</a>	143"	16" x 20" x 12"	83"	290 lbs.	<b>7972</b>
<a href="#">DTC-3-1824-144LorR</a>	143"	18" x 24" x 14"	77"	365 lbs.	<b>9674</b>
<a href="#">DTC-3-2020-96LorR</a>	95"	20" x 20" x 12"	23"	260 lbs.	<b>8384</b>
<a href="#">DTC-3-2020-108LorR</a>	107"	20" x 20" x 12"	35"	285 lbs.	<b>8543</b>
<a href="#">DTC-3-2020-120LorR</a>	119"	20" x 20" x 12"	48"	310 lbs.	<b>8673</b>
<a href="#">DTC-3-2020-144LorR</a>	143"	20" x 20" x 12"	71"	340 lbs.	<b>8858</b>
<a href="#">DTC-3-2424-144LorR*</a>	143"	24" x 24" x 14"	59"	380 lbs.	<b>9864</b>



DTC-3-1620-84L Shown

**BOWLS ARE LOCATED 12" IN FROM MACHINE**  
For Other Configurations, Contact Factory  
(Must Verify Machine For Control Box Or Drive Unit Interference)

\* Requires Two Faucets

For Upgrade To 14 Gauge Use "DTA-49" \$588

### PRERINSE BASKETS & WELDED SLIDE BARS

#### Prerinse Baskets with Slide Bar

Model #	Fits Bowls	Price	Wt.	Cu.
<a href="#">DTA-125</a>	16" x 20" x 4"	<b>\$538</b>	9 lbs.	1
<a href="#">DTA-100</a>	20" x 20" x 4"	<b>617</b>	12 lbs.	1
<b>Large Size Baskets</b>				
<a href="#">DTA-58</a>	18" x 24" x 4"	<b>788</b>	11 lbs.	1
<a href="#">DTA-59</a>	24" x 24" x 4"	<b>896</b>	20 lbs.	1



DTA-100  
Shown

#### Prerinse Slide Bars

Model #	Fits Bowls	Price	Wt.	Cu.
<a href="#">DTA-64</a>	16" x 20"	<b>\$305</b>	7 lbs.	1
<a href="#">DTA-60</a>	20" x 20"	<b>354</b>	9 lbs.	1
<b>Large Size Prerinse Slide Bars</b>				
<a href="#">DTA-51</a>	18" x 24"	<b>446</b>	8 lbs.	1
<a href="#">DTA-52</a>	24" x 24"	<b>530</b>	10 lbs.	1

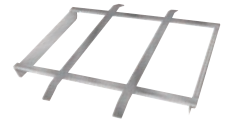

Prerinse Baskets & Slide Bar For Deep Drawn Bowls, See Page 84

### UNDERCOUNTER DISHTABLE

COMPACT - EFFICIENT - ECONOMICAL



DTU-U60-48R  
Shown

20" x 20" x 5"  
Sink Bowl

Left Or Right Designation Is  
Determined By Sink Location.

Length	Model #	Price	Approx. Weight	Approx. Cu. Ft.
48"	<a href="#">DTU-U60-48L</a>	<b>\$2733</b>	80 lbs.	17
48"	<a href="#">DTU-U60-48R</a>	<b>2733</b>	80 lbs.	17
60"	<a href="#">DTU-U60-60L</a>	<b>2878</b>	95 lbs.	19
60"	<a href="#">DTU-U60-60R</a>	<b>2878</b>	95 lbs.	19
72"	<a href="#">DTU-U60-72L</a>	<b>2993</b>	115 lbs.	23
72"	<a href="#">DTU-U60-72R</a>	<b>2993</b>	115 lbs.	23

### STAINLESS STEEL CONDENSATE HOODS



8" x 10" vent opening.  
Collar is centered 2" in height.

Model #	Length	Width	Height	Price
<a href="#">CH-3636</a>	36"	36"	20"	<b>\$4129</b>
<a href="#">CH-4242</a>	42"	42"	20"	<b>4445</b>
<a href="#">CH-4848</a>	48"	48"	20"	<b>4920</b>
<a href="#">CH-61</a>	Specify Alternate Collar Location			<b>173</b>
<a href="#">CH-56</a>	Additional Length Or Width			<b>506 /lin. Ft.</b>

This Item Is Not UL Or NFPA Listed.

### VENT RISER

- Type 300 Stainless Steel
- Adjustable Ceiling Trim Collar
- Accommodates Standard 4" x 16" Vent Hood Duct

(Custom Sizes Available - Consult Factory)

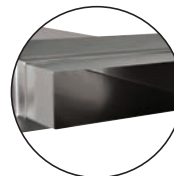

View of Opening

Model #	Length	Width	Height	Price
<a href="#">VR-1</a>	16"	4"	60"	<b>\$1969</b>

This Item Is Not UL Or NFPA Listed.





# DISHTABLE MODS

## Dishtable Modifications & Accessories

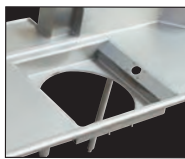

DTA-95

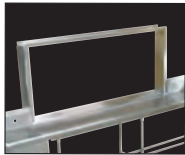

DTA-87



DTA-82



DTA-45

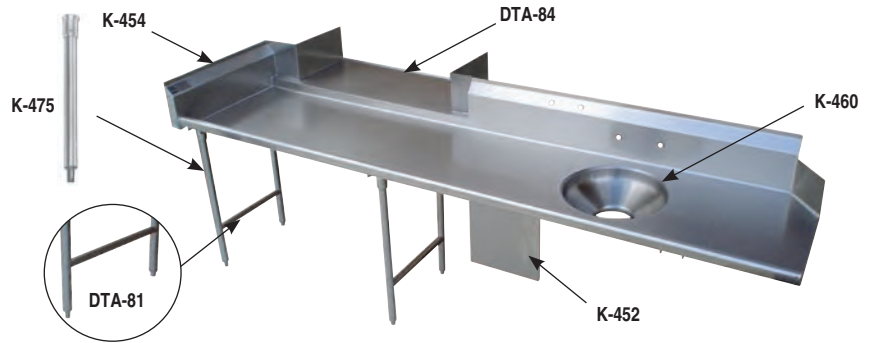

### MODIFICATIONS

<b>K-23</b>	Dishtable Legs Welded To Undershelf Or Left-To-Right Cross Rails, Shipped Set Up & Crated. (Top Is Not Welded To Legs)	<b>\$401 /sink</b>
<b>K-23</b>	Dishtable Legs Welded To Leg Gussets Under Sink Top & To Undershelf Or Left-To-Right Cross Rails, Shipped Set Up & Crated	<b>506 /sink</b>
<b>K-24</b>	Shell Crating	<b>296</b>
<b>K-37</b>	Anti-Siphon Vacuum Breaker Hole	<b>121</b>
<b>K-57</b>	Welded Field Joint (Welded In Field By Others)	<b>267</b>
<b>K-76</b>	Paint On Sound Deadening	<b>534 /sink</b>
<b>K-77</b>	Splash Cut-Out (Pipe Chase)	<b>189</b>
<b>K-440</b>	Waste Trough Installation Welded Into Table And Furnished With A 2" Deep Removable Basket	<b>914</b>
<b>K-452</b>	Control Bracket 8" x 12"	<b>267 ea.</b>
<b>K-453</b>	Control Bracket 14" x 16"	<b>287 ea.</b>
<b>K-454</b>	Side Splash	<b>415 ea.</b>
<b>K-456</b>	Scrap Block Installed (Includes Rubber Scrap Block)	<b>390 ea.</b>
<b>K-460</b>	Disposal Cone Welded Into Table And Furnished With 8" x 12" Control Bracket & Faucet Holes (Supplied By Others)	<b>798</b>
<b>K-460A</b>	Installation Of Disposal Cone With 14" x 16" Control Bracket, Faucet Holes (Cone Supplied By Others)	<b>848</b>
<b>K-461</b>	Disposal Collar Welded Into Sink Bowl And Furnished With 8" x 12" Control Bracket (Supplied By Others)	<b>798</b>
<b>K-461A</b>	Disposal Collar Welded Into Sink Bowl And Furnished With 14" x 16" Control Bracket (Supplied By Others)	<b>848</b>
<b>K-472</b>	Special Faucet Hole Location	<b>121 ea.</b>
<b>K-495</b>	Turn Down Backsplash (Incl. 2 Brackets. See K-397 For Add'l Sets)	<b>166</b>
<b>K-508A</b>	Special Modification Charge	<b>254</b>
<b>K-550</b>	Stainless Steel Tubular Rack Storage	<b>200 lin. ft.</b>

<b>DTA-40</b>	Drain Hole (For Sorting Table)	<b>\$137</b>
<b>DTA-45</b>	Scrap Trough Welded To Dump Sink - Min. Scrap Trough Length Is 3'. Max. Length Is 8'. For 20" x 20" x 8" Bowl Spec-Line Soil S30 Series Only. - Consult Factory For Trough Lengths Exceeding 8 Feet	<b>362 lin. ft.</b>
<b>DTA-46</b>	Inside Mitered Corner	<b>538</b>
<b>DTA-66</b>	Provision For Dishlanding On Straight Soil Table (Min 4")	<b>263 /lin. Ft.</b>
<b>DTA-70</b>	Install Booster Heater Brackets (Brackets By Others)	<b>169</b>
<b>DTA-72</b>	Provision For Side Loader	<b>1101</b>
<b>DTA-75</b>	Provision For Limit Switch (Limit Switch By Others)	<b>193</b>
<b>DTA-76</b>	Move Prerinse Sink To Conform To Dishmachine Requirements. Please Specify Machine When Placing Order	<b>N/C</b>
<b>DTA-78</b>	Notch In Backsplash Return To Clear Handle Please Specify Machine When Placing Order	<b>145</b>
<b>DTA-81</b>	S/S Welded Leg Assembly with S/S Feet	<b>309 /bowl</b>
<b>DTA-82</b>	15" x 20" x 8" Undercounter Dump Sink	<b>3597 /bowl</b>
<b>DTA-84</b>	Simple Pass-Thru (Specify Wall Thickness - Min. Length 36")	<b>641 /Ft.</b>
<b>DTA-87</b>	Pass-Thru Wall Frame (Specify Wall Thickness - Min. Length 36")	<b>366 /lin. Ft.</b>
<b>DTA-95</b>	Install Scrapper Top	<b>1770</b>
<b>DTA-96</b>	Install Trough Collector	<b>2179</b>
<b>DTA-99A</b>	16" x 20" x 12" Sink Bowls	<b>1369 /bowl</b>
<b>DTA-99B</b>	20" x 20" x 12" Sink Bowls	<b>1470 /bowl</b>
<b>DTA-99C</b>	10" x 14" x 5" Dump Sink	<b>1171 /bowl</b>
<b>DTA-99D</b>	18" x 24" x 14" Sink	<b>1607 /bowl</b>
<b>DTA-99E</b>	24" x 24" x 14" Sink	<b>1712 /bowl</b>
<b>DTA-106</b>	Mirror Highlight To Dishtable Upgrade	<b>422</b>

### ACCESSORIES

<b>K-4</b>	Lever Drain Bracket	<b>\$122</b>
<b>K-5</b>	Twist Handle Operated Drain	<b>265</b>
<b>K-15</b>	Twist Handle Operated Drain With Overflow	<b>469</b>
<b>K-397</b>	Wall Brackets (2 Each. Brackets Included With K-495)	<b>81 /set</b>
<b>K-455C</b>	Stainless Steel Sink Cover 16" x 20"	<b>471</b>
<b>K-455E</b>	Stainless Steel Sink Cover 20" x 20"	<b>471</b>
<b>K-457</b>	Replacement Rubber Scrap Block (See K-456 For Install Cost)	<b>119 ea.</b>
<b>K-475</b>	Replacement S/S Leg With Stainless Steel Bullet Foot	<b>68 ea.</b>
<b>K-478</b>	Replacement Stainless Steel Bullet Foot	<b>27 ea.</b>
<b>K-488</b>	Flanged S/S Bullet Foot	<b>58 ea.</b>
<b>K-550</b>	Stainless Steel Tubular Rack Storage	<b>200 /lin. Ft.</b>
<b>K-610</b>	Perforated Stainless Steel Sink Grid (Specify Bowl Size)	<b>706 ea.</b>
<b>K-700D</b>	12" High Removable Side Splash For Dishtables (Specify Model)	<b>457 ea.</b>
<b>DTA-53</b>	SPEC-LINE Heavy Duty Prerinse Faucet	<b>864</b>
<b>DTA-51</b>	Pre-Rinse Slide Bar for 18" x 24" Fab. Sink Bowls	<b>446</b>

<b>DTA-52</b>	Pre-Rinse Slide Bar for 24" x 24" Fab. Sink Bowls	<b>\$530</b>
<b>DTA-55</b>	Column Notch (Includes Splash)	<b>727</b>
<b>DTA-56</b>	Add'l Length On 59" Side Of Corner Or Straight Tables	<b>206 /lin. Ft.</b>
<b>DTA-58</b>	Pre-Rinse Basket w/ Slide Bar for 18" x 24" Fab. Sink Bowls	<b>788</b>
<b>DTA-59</b>	Pre-Rinse Basket w/ Slide Bar for 24" x 24" Fab. Sink Bowls	<b>896</b>
<b>DTA-60</b>	Pre-Rinse Slide Bar for 20" x 20" Fab. Sink Bowls	<b>354</b>
<b>DTA-62</b>	Pre-Rinse Basket For 20" x 20" Deep Drawn Bowls	<b>694</b>
<b>DTA-63</b>	Pre-Rinse Slide Bar For 20" x 20" Deep Drawn Bowls	<b>354</b>
<b>DTA-64</b>	Pre-Rinse Slide Bar For 16" x 20" Fab. Sink Bowls	<b>305</b>
<b>DTA-65</b>	Pre-Rinse Slide Bar For 16" x 20" Deep Drawn Bowls	<b>305</b>
<b>DTA-67</b>	Stainless Steel Rear Cross-Bracing (Factory Installed Only)	<b>34 /lin. Ft.</b>
<b>DTA-69</b>	Pre-Rinse Basket For 16" x 20" Deep Drawn Bowls	<b>660</b>
<b>DTA-100</b>	Pre-Rinse Basket with Slide Bar for 20" x 20" Fab. Sink Bowls	<b>617</b>
<b>DTA-125</b>	Pre-Rinse Basket with Slide Bar for 16" x 20" Fab. Sink Bowls	<b>538</b>
<b>DTA-125A</b>	Pre-Rinse Scrap Basket For DTA-82 Undermount Dump Sink	<b>720</b>



# Dishtables

## Dishtable Faucets & Accessories

= Ships via UPS

### SPEC-LINE EXTRA HEAVY DUTY 14" Splash Mounted Swing Spout Faucet



8" O.C.

**K-105 \$415**   
T&S Equivalent Model # B231

Splash Mounted  
Prerinse Faucet

**K-116 \$1199**

12" Add-A-Faucet

**K-117-TS \$526**  
(Fits K-116 Only)



## Prerinse Faucets

Prerinse Features:

- 8" O.C.
- Wall Bracket
- Continuous Spray Ring
- Heavy Duty Chrome Plated Spring

SPEC-LINE  
HEAVY DUTY  
Splash Mounted

**DTA-53 \$864**

T&S Equivalent  
Model # B133-B

12" Add-A-Faucet

**K-117 \$338**  
(Fits DTA-53 Only)

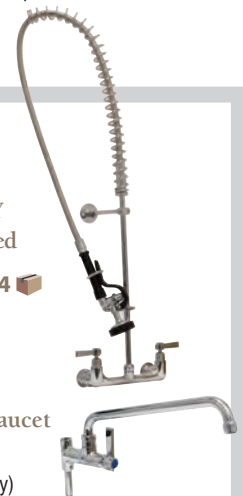

## Table Mounted SORTING SHELVES

Mounts to backsplash and end roll of dishtable  
(D, G and U-shaped Dishtables only)

Shelf Shipped Separate From Table To Reduce Freight  
Costs And Chance Of Shipping Damage.



New Versatile Design allows for  
Different Glass Rack Applications

- Drip Tubes For Water Drainage
- 14 Gauge End Plates
- 18 Gauge, 1 5/8" Tubes

**DTA-79 \$458 /lin. Ft.**



- Drip Tubes For Water Drainage
- 14 Gauge End Plates & Base
- 18 Gauge, 1 5/8" Tube

**DTA-79S \$582 /lin. Ft.**

## STAINLESS STEEL UNDERSHELVES

Additional Storage  
Shelving Is Reversible (Left Or Right)



Size Undershell To Be At Least  
6" Shorter Than Dishtable.

Now With Stainless Steel Legs!

Length	Model #	Price	Approx. Wt.	Approx. Cubes
18"	DTA-SS-18	\$431	11 lbs.	1
24"	DTA-SS-24	492	13 lbs.	1
30"	DTA-SS-30	520	15 lbs.	1
42"	DTA-SS-42	554	20 lbs.	2
54"	DTA-SS-54	631	23 lbs.	2
66"	DTA-SS-66	711	30 lbs.	3
78"	DTA-SS-78	754	35 lbs.	3
90"	DTA-SS-90	805	39 lbs.	4
102"	DTA-SS-102	912	45 lbs.	5
114"	DTA-SS-114	950	50 lbs.	5
126"	DTA-SS-126	1121	55 lbs.	6
138"	DTA-SS-138	1169	59 lbs.	6

## SORTING SHELVES

### Traditional Design

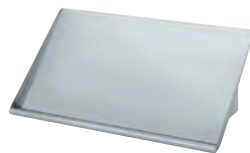

### KD Tubular Design



FOR TABLE MOUNTED, ADD **DTA-88 \$851**

Length	Model #	Racks	Price	Approx. Wt.	Approx. Cubes	Length	Model #	Racks	Price	Approx. Wt.	Approx. Cubes
22"	DT-6R-11	1	\$1242	20 lbs.	1	22"	DT-6R-21	1	\$925	15 lbs.	1
42"	DT-6R-12	2	1328	30 lbs.	2	42"	DT-6R-22	2	1043	23 lbs.	2
62"	DT-6R-13	3	1403	40 lbs.	4	62"	DT-6R-23	3	1112	30 lbs.	4
82"	DT-6R-14	4	1488	50 lbs.	5	82"	DT-6R-24	4	1181	38 lbs.	5

## SORTING TABLES

16 Gauge 304 Stainless Steel • 3" Raised Edge  
**STAINLESS STEEL CROSS BRACING ON ALL SIDES**

### Standard

Model #	Price	Size	Approx. Wt.	Approx. Cubes
<b>SR-48</b>	<b>\$2022</b>	48" x 30"	84 lbs.	12
<b>SR-60</b>	<b>2140</b>	60" x 30"	98 lbs.	15
<b>SR-72</b>	<b>2259</b>	72" x 30"	109 lbs.	18
<b>SR-96</b>	<b>2526</b>	96" x 30"	143 lbs.	21



Shown With  
Optional Casters

### 10 1/2" Backsplash

Model #	Price	Size	Approx. Wt.	Approx. Cubes
<b>BSR-48</b>	<b>\$2045</b>	48" x 30"	88 lbs.	12
<b>BSR-60</b>	<b>2155</b>	60" x 30"	103 lbs.	15
<b>BSR-72</b>	<b>2272</b>	72" x 30"	115 lbs.	18
<b>BSR-96</b>	<b>2611</b>	96" x 30"	150 lbs.	21



- TA-255** Super Heavy Duty Casters ..... **\$539**
- DTA-40** Drain Hole ..... **137**

**WARNING:** Faucets on this page may contain a chemical known to the State of California to cause cancer, birth defects or other reproductive harm.

# Underbar Basics™

## Featuring New Extended Widths!

Sinks, Blender Stations, Drainboards & Liquor Racks now have a new flush design for a clean, linear appearance when adding SRK Speed Rails.



### Features and Benefits

- 18", 21", 23" & 26" Widths
- 4" Backsplash
- All Units Come with 4 Galvanized Legs w/ Adjustable Plastic Bullet Feet
- Selected Models Feature Adjustable Galvanized Cross-Bracing (Front to Back)
- Embossed & Seamless Drainboards (Where Applies)
- Blender Stations Include Hidden Duplex Electrical Outlet



# UNDERBAR DROP-INS



## Drop-In Ice Bins, Water Stations & Hand Sinks

### DROP-IN WATER STATIONS

Includes K-54 Deck Mount Faucet With "Push-Back" Acrylic Lever Arm



Ice Bin Inside Dim.:  
8" x 13 1/2" x 10 13/16"  
Ice Capacity: 23 lbs.



Ice Bin Inside Dim.:  
13 1/2" x 18 3/4" x 10 13/16"  
Ice Capacity: 50 lbs.

### Underbar Basics™

For Custom Cut-Out Use  
Model # TA-34 \$254



Overall Size:  
12" x 14"

#### D-24-WSIBL \$1303

Removable Grate Covers Drip Pan  
13" Deep Insulated Ice Bin w/ S/S Steel Cover  
1" IPS Drain  
Outside Dim. 21" x 18"  
Cut-Out Size: 20 5/8" x 15 1/4"  
30 lbs. 5 cu. Ft.

#### D-24-WSIBL2 \$1565

Removable Grate Covers Drip Pan  
13" Deep Insulated Ice Bin w/ S/S Steel Cover  
1" IPS Drain  
Outside Dim.: 18" x 21"  
Cut-Out Size: 15 1/4" x 20 5/8"  
47 lbs. 5 cu. Ft.

#### DI-1-9 \$1000

Removable Electro-Polished  
Stainless Steel Grill  
1 1/2" IPS Basket Drain  
Cut-Out Size: 11 1/4" x 13 1/4"  
15 lbs. 3 cu. Ft.

### DROP-IN BAR HAND SINKS

Featuring Deep Drawn Sink Bowls



Overall Size:  
13" x 19"

SPACE SAVER



Overall Size:  
12" x 14"



Hand Sink Bowl Size:  
9" x 9" x 4"  
Ice Bin Inside Dim.:  
8" x 13 1/2" x 10 13/16"  
Ice Capacity: 23 lbs.

#### DI-1-5 \$510

K-52 Deck Mounted Faucet  
1 1/2" IPS Basket Drain  
Cut-Out Size: 12 1/4" x 18 1/4"  
20 Gauge Stainless Steel  
12 lbs. 2 cu. Ft.

#### DI-1-25 \$632

K-52 Deck Mounted Faucet  
1 1/2" IPS Basket Drain  
Cut-Out Size: 11 1/4" x 13 1/4"  
20 Gauge Stainless Steel  
8 lbs. 2 cu. Ft.

#### D-24-SIBL \$1396

K-51 Deck Mounted Faucet  
Insulated Ice Bin w/ S/S Cover  
1" IPS Drain In Ice Bin  
Outside Dim.: 21" x 18"  
Cut-Out Size: 20 5/8" x 15 1/4"  
Factory Installed Only  
20 Gauge Galvanized Steel  
30 lbs. 5 cu. Ft.

For Our Full Line Of Drop-in Sinks, See pages 3-5

## ACCESSORIES & MODIFICATIONS

### Replacement Sliding Stainless Steel Covers

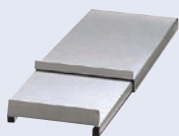

D-12  
Shown

Model #	Price	For Use With:
D-12	\$94	D-12-IBL, D-24-WSIBL, D-24-WSIBL2, D-24-SIBL
D-24	108	D-24-IBL, D-24-IBL-7
D-24V	121	D-24-IBL, D-24-IBL-7
D-30	153	Units oriented with 18" dimension left-to-right D-30-IBL, D-30-IBL-7
D-36	174	D-36-IBL, D-36-IBL-7

Cover designed to open front-to-rear, with 18" ice bin dimension front-to-rear.  
(D-24-WSIBL2 opens left to right when installed with 21" front-to-rear)



Add Wrist Handles  
K-316-LU  
\$114

### Water Filler Faucets

K-54 8-1/4" High \$468  
K-54A 12" High \$576  
K-54OMIT - \$385  
Omit K-54 Faucet



6" Deck  
Mounted Faucet  
K-51 \$452  
4" O.C.



3 1/2" Gooseneck  
Deck Mounted Faucet  
K-52 \$221



# UNDERBAR DROP-INS

## Drop-In Ice Bins, Bar Sinks & Drain Pans

### Underbar Basics™

- Rubber Thermal Breaker Reduces Condensation
- Optional 7-Circuit Cold Plate Sealed Into The Bottom

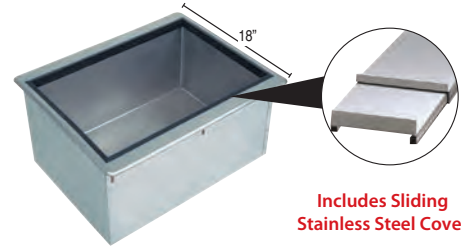

Includes Sliding Stainless Steel Cover

For Replacement Sliding Stainless Steel Covers, See Page 90.

## DROP-IN ICE BINS

11" Deep Insulated Ice Bin w/ Sliding Stainless Steel Cover

Model #	Price	Overall Length	Cut Out Size W x L	Ice Capacity	Approx. Weight	Approx. Cu. Ft.
D-12-IBL	\$1096	12"	15 1/4" x 9 5/8"	23 lbs.	22 lbs.	3
D-24-IBL	1194	21"	15 1/4" x 20 3/8"	50 lbs.	39 lbs.	5
D-30-IBL	1230	27"	15 1/4" x 26 3/8"	62 lbs.	62 lbs.	8
D-36-IBL	1374	33"	15 1/4" x 32 3/8"	75 lbs.	67 lbs.	9
w/ 7-CIRCUIT COLD PLATE						
D-24-IBL-7	2802	21"	15 1/4" x 20 3/8"	50 lbs.	84 lbs.	9
D-30-IBL-7	2767	27"	15 1/4" x 26 3/8"	62 lbs.	107 lbs.	13
D-36-IBL-7	2932	33"	15 1/4" x 32 3/8"	75 lbs.	113 lbs.	15

## DROP-IN BAR SINKS

Optional Built-in Embossed Drainboard

- 10" x 14" x 10" Sink Bowls
- 9" High Overflow Pipe(s) w/ 1 1/2" IPS Drain(s)
- 4" O.C. Deck Mounted Swing Faucet
- 4" O.C. Deck Mounted Faucet

Model #	Price	# of Bowls	# of Drbds.	Drbd. Size	Drbd. Location	Outside Dim. W x L	Cut Out Size W x L	Approx. Weight	Approx. Cu. Ft.
DBS-1	\$847	1	0	N/A	N/A	13" x 19"	12 1/4" x 18 1/4"	21 lbs.	3
DBS-2	951	2	0	N/A	N/A	25 1/2" x 19"	24 3/4" x 18 1/4"	26 lbs.	4
DBS-3	1145	3	0	N/A	N/A	38" x 19"	37 1/4" x 18 1/4"	42 lbs.	9
DBS-43L	1725	3	1	12"	Right	21 1/8" x 48 5/16"	17" x 47"	88 lbs.	10
DBS-43R	1725	3	1	12"	Left	21 1/8" x 48 5/16"	17" x 47"	88 lbs.	10
DBS-53C	1877	3	2	12"	Left & Right	21 1/8" x 60 5/16"	17" x 59"	100 lbs.	21
DBS-63C	1961	3	2	18"	Left & Right	21 1/8" x 72 5/16"	17" x 71"	110 lbs.	24

L and R Indicate Sink Location. C Indicates Sink is Centered.



DBS-1

DBS-53C shown

## 18" WIDE COUNTERTOP DRAIN PAN

- Removable Drip Tray
- Stainless Steel Top
- 1/2" NPT Drain

**CUSTOM SIZES AVAILABLE**  
Consult Factory For Details

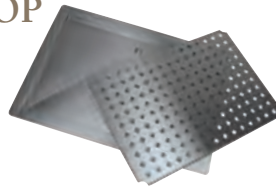

Model #	Price	Size W x L	Cut Out Size	Approx. Weight	Approx. Cu. Ft.
DP-1818	\$781	18" x 18"	15 3/4" x 15 3/4"	18 lbs.	2
DP-1824	798	18" x 24"	15 3/4" x 21 3/4"	23 lbs.	2
DP-1830	816	18" x 30"	15 3/4" x 27 3/4"	28 lbs.	3
DP-1836	844	18" x 36"	15 3/4" x 33 3/4"	33 lbs.	3
DP-1842	907	18" x 42"	15 3/4" x 39 3/4"	38 lbs.	4
DP-1848	978	18" x 48"	15 3/4" x 45 3/4"	43 lbs.	4

## BAR DRINK RAILS

- Type 300 Stainless Steel
- 8" Wide (Front To Back) x 3/4" Deep
- Perforated Removable Grate Allows For Easy Cleaning
- 1" Drain On Right Side
- Designed To Secure To Underside Of Wood Substrate

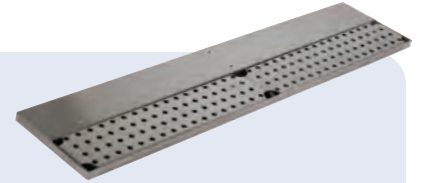

Model #	Price	Size W x L	Approx. Weight	Approx. Cu. Ft.
DRKR-12	\$283	8" x 12"	10 lbs.	2
DRKR-18	315	8" x 18"	15 lbs.	2
DRKR-24	331	8" x 24"	20 lbs.	2
DRKR-30	381	8" x 30"	25 lbs.	2
DRKR-36	423	8" x 36"	30 lbs.	3
DRKR-42	478	8" x 42"	35 lbs.	3
DRKR-48	538	8" x 48"	40 lbs.	3

### OPTIONS

- DRKC-45-IC  
45° Inside Corner
- DRKC-45-OC  
45° Outside Corner  
**\$528 ea.**
- DRKC-90-IC  
90° Inside Corner
- DRKC-90-OC  
90° Outside Corner  
**\$528 ea.**

## COUNTERTOP GLASS RINSER

Rinses away any impurities that might be in the glass!

- Mounts Easily to countertop or bar equipment
- Brushed Stainless Steel
- Water Rinsing And Glass Actuator By Pushing Down On Glass
- Threaded Drain For 1/2" Drain Hose



**FACTORY INSTALLED ONLY**

Model #	Price	Size W x L x H	Approx. Wt	Approx. Cu. Ft.
SU-16	\$697	6 3/8" x 6 3/8" x 3/4"	7 lbs.	1

## UNDERCOUNTER GLASS RINSER

Rinses away any impurities that might be in the glass!

- Mounts Easily to Underside Of Wood Substrate
- Brushed Stainless Steel
- Retrofit any liquid dispense station
- Water Rinsing And Glass Actuator By Pushing Down On Glass
- Threaded Drain For 1/2" Drain Hose



Model #	Price	O.A. W x L x H	Rinsing Size W x L x H	Approx. Wt	Approx. Cu. Ft.
SU-16UM	\$924	6 3/8" x 11 3/8" x 1"	6-3/8" x 6-3/8" x 1"	8 lbs.	1

# BAR HAND SINKS

## Free Standing Bar Hand/Dump Sinks

Underbar **Basics™**



### BAR HAND SINKS

Bowl Size: 10" x 14" x 10" • 29" Working Height • 4" High Backsplash  
Includes 1-1/2" IPS Drain & Galvanized Legs w/ Adjustable Galvanized Side Cross-Bracing & Adjustable Plastic Bullet Feet  
Add **SU-10A** For Stainless Steel Leg & Stainless Steel Bullet Foot Upgrade w/ Front-to-Back Cross-Bracing **\$230**



#### 18" Wide Units

- 4" O.C. Splash Mounted Swing Spout Faucet

Model #	Price	Overall Length	Approx. Weight	Approx. Cu. Ft.
<b>SL-HS-12</b>	<b>\$799</b>	12"	31 lbs.	5
<b>SL-HS-15</b>	<b>846</b>	15"	34 lbs.	6



#### 21" Wide Units

- 4" O.C. Deck Mounted Swing Spout Faucet
- Rear Deck For Extra Storage

Model #	Price	Overall Length	Approx. Weight	Approx. Cu. Ft.
<b>CR-HS-12</b>	<b>\$832</b>	12"	32 lbs.	6
<b>CR-HS-15</b>	<b>875</b>	15"	35 lbs.	6

## HAND SINKS W/ BUILT-IN SOAP & TOWEL DISPENSERS

Bowl & Faucet • 29" Working Height • 4" High Backsplash  
Includes 1 1/2" IPS Basket Drain & Galvanized Legs w/ Adjustable Galvanized Side Cross-Bracing & Adjustable Plastic Bullet Feet  
Add **SU-10C** For Stainless Steel Leg & Stainless Steel Bullet Foot Upgrade w/ Front-to-Back Cross-Bracing **\$230**



#### 21" Wide Standard Units

- 4" O.C. Deck Mounted Swing Spout Faucet
- Rear Deck For Extra Storage

Model #	Price	Overall Length	Approx. Weight	Approx. Cu. Ft.
<b>SC-12-TS</b>	<b>\$1168</b>	12"	45 lbs.	4
<b>SC-15-TS</b>	<b>1195</b>	15"	49 lbs.	4



#### 21" Wide Side Splash Units

- 4" O.C. Deck Mounted Swing Spout Faucet
- 4" High Stainless Steel Side Splashes
- Rear Deck For Extra Storage

Model #	Price	Overall Length	Approx. Weight	Approx. Cu. Ft.
<b>SC-12-TS-S</b>	<b>\$1382</b>	12"	50 lbs.	4
<b>SC-15-TS-S</b>	<b>1418</b>	15"	54 lbs.	4

**18" Wide Units Available - Consult Factory**

## HAND SINK ACCESSORIES & MODIFICATIONS



#### Add Wrist Handles

**K-316-LU \$114**  
For Deck & Splash Mount Faucets



#### Replacement Deck Mount Soap Dispenser

**K-12 \$144**



#### Chrome Towel Ring

**A-15 \$96** Packed Loose



#### Replacement 6" Splash Mount Faucet

**K-125 \$295**  
4" O.C. 6" Spout

#### Add A Side Splash

**SU-18R or L \$161**  
**SU-18RL \$325**

For 21" Wide Units  
**SU-21R or L \$175**

**SU-21RL \$341**



#### Stainless Steel Leg Upgrade

- Includes 2 Sets of (2) S/S Legs w/ Adjustable S/S Bullet Feet & Adjustable S/S Front-to-Back Cross-Bracing
- Leg Heights Do Not Include 1 1/4" Bullet Foot Height

**SU-10A \$243** 18" Legs

**SU-10C \$243** 14" Legs



#### Replacement 6" Deck Mount Faucet

**K-51 \$452**  
4" O.C. 6" Spout

For Our Full Line Of Modifications & Accessories, See Page 116-118.

## BAR SINKS

w/ 10" x 14" x 10"

- 4" High Backsplash
- 29" working Height
- Molded Apron For Extra Durability
- Each Sink Bowl Includes an Overflow Pipe w/ 1 1/2" IPS Drain
- Galvanized Legs w/ Adjustable Galvanized Side Cross-Bracing & Adjustable Plastic Bullet Feet
- **SLB Series** Includes 1 - 4" O.C. Splash Mounted Swing Spout Faucet
- **CRB Series** Includes 1 - 4" O.C. Deck Mounted Swing Spout Faucet & Has Rear Deck For Extra Storage
- **4 Comp. Sinks** Include Two 6" Swing Spout Faucets



**SLB Series**  
18" Wide Units With  
Splash Mount Faucet



**CRB Series**  
21" Wide Units With  
Deck Mount Faucet



L And R Indicate Sink Location. C Indicates Sink Is Centered.

	SPLASH MOUNT FAUCET				DECK MOUNT FAUCET				O.A. Length	# of Drbds.	Drbd. Length	Approx. Cu. Ft.
	18" WIDE	Price	Spout Size	Approx. Wt.	21" WIDE	Price	Spout Size	Approx. Wt.				
<b>1 COMP.</b>	<b>SLB-31C</b>	<b>\$1277</b>	6"	55 lbs.	<b>CRB-31C</b>	<b>\$1409</b>	6"	55 lbs.	36"	2	12"	13
<b>2 COMP.</b>	<b>SLB-22C</b>	<b>1349</b>	6"	54 lbs.	<b>CRB-22C</b>	<b>1452</b>	6"	54 lbs.	24"	0	N/A	8
	<b>SLB-32LorR</b>	<b>1432</b>	6"	57 lbs.	<b>CRB-32LorR</b>	<b>1527</b>	6"	57 lbs.	36"	1	9"	13
	<b>SLB-42LorR</b>	<b>1468</b>	6"	62 lbs.	<b>CRB-42LorR</b>	<b>1573</b>	6"	62 lbs.	48"	1	21"	15
	<b>SLB-42C</b>	<b>1479</b>	6"	66 lbs.	<b>CRB-42C</b>	<b>1585</b>	6"	66 lbs.	48"	2	12"	15
<b>3 COMP.</b>	<b>SLB-33C</b>	<b>1547</b>	10"	65 lbs.	<b>CRB-33C</b>	<b>1653</b>	12"	65 lbs.	36"	0	N/A	13
	<b>SLB-43LorR</b>	<b>1627</b>	10"	68 lbs.	<b>CRB-43LorR</b>	<b>1740</b>	12"	68 lbs.	48"	1	9"	15
	<b>SLB-53C</b>	<b>1712</b>	10"	76 lbs.	<b>CRB-53C</b>	<b>1831</b>	12"	76 lbs.	60"	2	12"	18
	<b>SLB-63C</b>	<b>1804</b>	10"	88 lbs.	<b>CRB-63C</b>	<b>1931</b>	12"	88 lbs.	72"	2	18"	22
	<b>SLB-73C</b>	<b>2006</b>	10"	162 lbs.	<b>CRB-73C</b>	<b>2146</b>	12"	170 lbs.	84"	2	24"	39
<b>4 COMP.</b>	<b>SLB-83C</b>	<b>2193</b>	10"	183 lbs.	<b>CRB-83C</b>	<b>2353</b>	12"	191 lbs.	96"	2	30"	44
	<b>SLB-64C*</b>	<b>2130</b>	6"	92 lbs.	<b>CRB-64C*</b>	<b>2269</b>	6"	92 lbs.	72"	2	12"	22
	<b>SLB-74C*</b>	<b>2267</b>	6"	164 lbs.	<b>CRB-74C*</b>	<b>2424</b>	6"	172 lbs.	84"	2	18"	39
	<b>SLB-84C*</b>	<b>2463</b>	6"	185 lbs.	<b>CRB-84C*</b>	<b>2623</b>	6"	193 lbs.	96"	2	24"	44

\*4 Comp. Bar Sinks Include 2 - 6" Swing Spout Faucets

## BAR SINK & ICE BIN COMBO

With Removable Plastic Bottle Racks

- 4" Backsplash
- 29" Working Height
- Three or Four Compartment - 10" x 14" Bowls
- Each Sink Bowl Includes Overflow Pipe & 1-1/2" I.P.S. Drain
- Molded Apron For Extra Durability
- 24" x 15" x 8" Insulated Ice Bin; 54 lbs. Ice Capacity
- Ice Bin Includes 1" IPS Drain
- Galvanized Legs w/ Adjustable Galvanized Side Cross-Bracing & Adjustable Plastic Bullet Feet
- **SLC Series** Includes 1 - 4" O.C., 10" Splash Mounted Swing Spout Faucet
- **CRC Series** Includes 1 - 4" O.C., 12" Deck Mounted Swing Spout Faucet & Has Rear Deck For Extra Storage



**SLC-83C-R**

L And R Indicates Ice Bin Location.

SPLASH MOUNT FAUCET		DECK MOUNT FAUCET		O.A. Length	# of Bowls	# of Drbds.	Drbd. Length	Approx. Weight	Approx. Cu. Ft.
18" WIDE	Price	21" WIDE	Price						
<b>SLC-73C-LorR</b>	<b>\$2584</b>	<b>CRC-73C-LorR</b>	<b>\$2762</b>	84"	3	2	12"	185 lbs.	28
<b>SLC-83C-LorR</b>	<b>2679</b>	<b>CRC-83C-LorR</b>	<b>2857</b>	96"	3	2	18"	225 lbs.	32
<b>SLC-84C-LorR*</b>	<b>3001</b>	<b>CRC-84C-LorR*</b>	<b>3199</b>	96"	4	2	12"	225 lbs.	32

\*4 Comp. Bar Sinks Include 2 - 6" Swing Spout Faucets

## BAR SINK MODIFICATIONS

### Add A Side Splash

For 18" Wide Units  
**SU-18R or L** **\$161**  
**SU-18RL** **\$325**

For 21" Wide Units  
**SU-21R or L** **\$175**  
**SU-21RL** **\$341**

### Stainless Steel Leg Upgrade

- Includes 2 Sets of (2) S/S Legs w/ Adj. S/S Bullet Feet & Adj. S/S Front-to-Back Cross-Bracing
  - Leg Heights Do Not Include 1 1/4" Bullet Foot Ht.
- SU-10A** **\$243**  
18" Legs

For Our Full Line Of Speed Rails, See Page 101.

# ICE BINS

**All Bottle Racks Must Be Removed For NSF Compliance & For Use With Optional Cover**

**Underbar Basics™**

## ICE BINS

12" or 16" Deep Insulated Ice Bins • 29" Working Height

- 4" Backsplash
- Includes Two Removable Plastic Bottle Racks
- Galvanized Legs w/ Adjustable Galvanized Side Cross-Bracing & Adjustable Plastic Bullet Feet
- **CRI Series** Has Rear Deck For Extra Storage
- Optional 7 or 10 Circuit Cold Plate Sealed Into The Bottom



**SLI Series**  
18" Wide Units

Quick Pour Bottles Not Included



**CRI Series**  
21" Wide Units

Ice Bin Depth	Overall Length	Ice Bin Capacity	18" WIDE	Price	Approx. Weight	21" WIDE	Price	Approx. Weight	Approx. Cu. Ft.
<b>12" DEEP</b>	12"	35 lbs.	<b>SLI-12-12</b>	<b>\$852</b>	26 lbs.	<b>CRI-12-12</b>	<b>\$928</b>	50 lbs.	6
	24"	77 lbs.	<b>SLI-12-24</b>	<b>1078</b>	52 lbs.	<b>CRI-12-24</b>	<b>1150</b>	65 lbs.	8
	30"	98 lbs.	<b>SLI-12-30</b>	<b>1191</b>	60 lbs.	<b>CRI-12-30</b>	<b>1273</b>	72 lbs.	11
	36"	119 lbs.	<b>SLI-12-36</b>	<b>1303</b>	68 lbs.	<b>CRI-12-36</b>	<b>1396</b>	80 lbs.	13
	42"	140 lbs.	<b>SLI-12-42</b>	<b>1363</b>	72 lbs.	<b>CRI-12-42</b>	<b>1454</b>	90 lbs.	13
	48"	161 lbs.	<b>SLI-12-48</b>	<b>1424</b>	87 lbs.	<b>CRI-12-48</b>	<b>1505</b>	98 lbs.	14
<b>16" DEEP</b>	24"	100 lbs.	<b>SLI-16-24</b>	<b>1381</b>	68 lbs.	<b>CRI-16-24</b>	<b>1484</b>	72 lbs.	8
	30"	127 lbs.	<b>SLI-16-30</b>	<b>1537</b>	69 lbs.	<b>CRI-16-30</b>	<b>1651</b>	82 lbs.	12
	36"	155 lbs.	<b>SLI-16-36</b>	<b>1695</b>	70 lbs.	<b>CRI-16-36</b>	<b>1817</b>	90 lbs.	17
<b>w/ 7-CIRCUIT COLD PLATE</b>									
<b>12" DEEP</b>	24"	77 lbs.	<b>SLI-12-24-7</b>	<b>2211</b>	89 lbs.	<b>CRI-12-24-7</b>	<b>2284</b>	122 lbs.	8
	30"	128 lbs.	<b>SLI-12-30-7</b>	<b>2325</b>	97 lbs.	<b>CRI-12-30-7</b>	<b>2406</b>	135 lbs.	11
	36"	149 lbs.	<b>SLI-12-36-7</b>	<b>2435</b>	105 lbs.	<b>CRI-12-36-7</b>	<b>2528</b>	147 lbs.	13
	42"	170 lbs.	<b>SLI-12-42-7</b>	<b>2494</b>	109 lbs.	<b>CRI-12-42-7</b>	<b>2585</b>	163 lbs.	13
	48"	191 lbs.	<b>SLI-12-48-7</b>	<b>2557</b>	124 lbs.	<b>CRI-12-48-7</b>	<b>2592</b>	175 lbs.	14
<b>16" DEEP</b>	24"	100 lbs.	<b>SLI-16-24-7</b>	<b>2512</b>	105 lbs.	<b>CRI-16-24-7</b>	<b>2616</b>	136 lbs.	8
	30"	127 lbs.	<b>SLI-16-30-7</b>	<b>2667</b>	106 lbs.	<b>CRI-16-30-7</b>	<b>2784</b>	143 lbs.	12
	36"	155 lbs.	<b>SLI-16-36-7</b>	<b>2830</b>	107 lbs.	<b>CRI-16-36-7</b>	<b>2950</b>	150 lbs.	17
<b>w/ 10-CIRCUIT COLD PLATE</b>									
<b>12" DEEP</b>	30"	98 lbs.	<b>SLI-12-30-10</b>	<b>2910</b>	132 lbs.	<b>CRI-12-30-10</b>	<b>3015</b>	143 lbs.	11
	36"	119 lbs.	<b>SLI-12-36-10</b>	<b>3022</b>	140 lbs.	<b>CRI-12-36-10</b>	<b>3099</b>	178 lbs.	13
	42"	140 lbs.	<b>SLI-12-42-10</b>	<b>3097</b>	144 lbs.	<b>CRI-12-42-10</b>	<b>3252</b>	195 lbs.	13
	48"	161 lbs.	<b>SLI-12-48-10</b>	<b>3228</b>	159 lbs.	<b>CRI-12-48-10</b>	<b>3370</b>	205 lbs.	14
<b>16" DEEP</b>	30"	127 lbs.	<b>SLI-16-30-10</b>	<b>3333</b>	141 lbs.	<b>CRI-16-30-10</b>	<b>3592</b>	151 lbs.	12
	36"	155 lbs.	<b>SLI-16-36-10</b>	<b>3582</b>	142 lbs.	<b>CRI-16-36-10</b>	<b>3805</b>	185 lbs.	17

## ICE BIN ACCESSORIES & MODIFICATIONS



### Sliding Stainless Steel Covers For Ice Bins

For SLI & CRI Series

<b>SSC-12</b>	For 12" Ice Bin	.....	<b>\$169</b>
<b>SSC-24</b>	For 24" Ice Bin	.....	<b>174</b>
<b>SSC-30</b>	For 30" Ice Bin	.....	<b>190</b>
<b>SSC-36</b>	For 36" Ice Bin	.....	<b>205</b>
<b>SSC-42</b>	For 42" Ice Bin	.....	<b>256</b>
<b>SSC-48</b>	For 48" Ice Bin	.....	<b>263</b>

For Older Style Ice Bins Prior to 2015

<b>SSC-23</b>	For 24" Ice Bin	.....	<b>\$217</b>
<b>SSC-29</b>	For 30" Ice Bin	.....	<b>233</b>
<b>SSC-35</b>	For 36" Ice Bin	.....	<b>248</b>



### Stainless Steel Leg Upgrade

Includes 2 Sets of (2) S/S Legs w/ Adj. S/S Bullet Feet & Adj. S/S Front-to-Back Cross-Bracing

<b>SU-10B</b>	10" legs (16" Deep Ice Bins)	.....	<b>\$243</b>
<b>SU-10C</b>	14" legs (12" Deep Ice Bins)	.....	<b>243</b>

Leg Heights Do Not Include 1 1/4" Bullet Foot Height

A-39



### Stainless Steel Ice Bin Partitions

<b>A-38</b>	8" High x 14 3/4" Wide Partition	.....	<b>122</b>
<b>A-39</b>	12" High x 14 3/4" Wide Partition	.....	<b>122</b>
<b>A-40</b>	16" High x 14 3/4" Wide Partition	.....	<b>122</b>

SU-30



<b>SU-24</b>	Provision To Connect Underbar Equipment (Price Per Every Two Units)	.....	<b>140</b>
<b>SU-30</b>	Soda Chase Provision (Tip-Out) (Only For Ice Bins w/Backsplash)	.....	<b>447</b>



### ICE BIN & BOTTLE STORAGE COMBO

Featuring 12" Deep Insulated Ice Bin

- 4" Backsplash
- 29" working height
- 1 or 2 Insulated 12" Wide Bottle Rack Bins
- Includes 3-Pack Plastic Bottle Rack(s)
- Welded Partition Between Bins
- Galvanized Legs w/ Adjustable Galvanized Side Cross-Bracing & Adjustable Plastic Bullet Feet
- Two 1" I.P.S. Drains (Cold Plate Units have 1/2" I.P.S. Drain in Ice Bin Area)
- Optional 7-Circuit Cold Plate Sealed Into The Bottom

21" WIDE		L	# Of Bins	# Of Btl. Racks	Ice Bin Length	Ice Bin Capacity*	Approx. Weight	Approx. Cu. Ft.
Model #	Price							
CRCI-36L or R	\$2078	36"	2	2	24"	77/35 lbs.	82 lbs.	14
CRCI-48L or R	2320	48"	2	2	36"	119/35 lbs.	95 lbs.	14
CRCI-48LR	3005	48"	3	4	24"	35/77/35 lbs.	113 lbs.	15
<b>w/ 7-CIRCUIT COLD PLATE</b>								
CRCI-36L-7 or R-7	3441	36"	2	2	24"	77/35 lbs.	114 lbs.	14
CRCI-48L-7 or R-7	3684	48"	2	2	36"	119/35 lbs.	127 lbs.	14
CRCI-48LR-7	4369	48"	3	4	24"	35/77/35 lbs.	145 lbs.	15

\*Reverse Ice Bin Capacities For L or R Models. L And R Indicate Ice Bin Location On Either Right Or Left Side. LR Indicates Ice Bin Is Centered.

Quick Pour Bottles Not Included



CRCI-48L

### INSULATED BOTTLE STORAGE BIN

Featuring 12" Deep Insulated Ice Bin

- 4" Backsplash
- 29" working height
- Includes Two 3-Pack Plastic Bottle Racks
- Galvanized Legs w/ Adjustable Galvanized Side Cross-Bracing & Adjustable Plastic Bullet Feet
- 1" I.P.S. Drain

18" WIDE		21" WIDE		L	Ice Bin Capacity	Approx. Weight	Approx. Cu. Ft.
Model #	Price	Model #	Price				
SLI-12-12	\$852	CRI-12-12	\$928	12"	35 lbs.	35 lbs.	6

Quick Pour Bottles Not Included



SLI-12-12

### ICE BIN & DRAINBOARD COMBO

Featuring 10" Deep Insulated Ice Bin

- 4" Backsplash
- 29" working height
- 24" Ice Bin
- 24" Seamless & Embossed Drainboard
- Galvanized Legs w/ Adjustable Galvanized Side Cross-Bracing & Adjustable Plastic Bullet Feet
- 1" I.P.S. Drain (Cold Plate Units have 1/2" I.P.S. Drain in ice Bin Area)
- Optional 7-Circuit Cold Plate Sealed Into The Bottom

21" WIDE		L	Ice Bin Capacity	Approx. Weight	Approx. Cu. Ft.
Model #	Price				
CRW-4R	\$2167	48"	54 lbs.	72 lbs.	13
CRW-4L	2167	48"	54 lbs.	72 lbs.	13
<b>w/ 7-CIRCUIT COLD PLATE</b>					
CRW-4R-7	2997	48"	54 lbs.	108 lbs.	13
CRW-4L-7	2997	48"	54 lbs.	108 lbs.	13

\*L And R Indicate Ice Bin Location On Either Right Or Left Side.



CRW-4L

### PORTABLE ICE BIN

16" Deep

- Insulated Ice Bin
- 29" working height
- Stainless Steel Welded Cross-Braced Legs w/ Casters (2 w/ Brakes)
- 1" IPS Drain w/ Shut Off Valve

**EXTRA DEEP**  
For Beer Bottle Storage

18 3/4" WIDE		Size L x W x H	Ice Bin Capacity	Approx. Weight	Approx. Cu. Ft.
Model #	Price				
SCI-MIC-24	\$1394	24" x 18 3/4" x 29"	100 lbs.	120 lbs.	7
SCI-MIC-30	1455	30" x 18 3/4" x 29"	127 lbs.	130 lbs.	12
SCI-MIC-36	1562	36" x 18 3/4" x 29"	155 lbs.	145 lbs.	16



SCI-MIC-36

# BAR PASS-THRU

## Pass-Thru Workstations & Ice Bins

Underbar **Basics™**

### STANDARD DOUBLE SINK PASS-THRU WORKSTATION

With Two Deep Drawn Sink Bowls

- 29" working height
- Insulated Ice Bin w/ 7-Circuit Cold Plate Sealed Into Bottom Of Ice Bin
- Tubing Chase For Soda Gun
- Double Tier Speed Rail
- 4" O.C. Lead Free Compliant Deck Mounted Swing Spout Faucet
- Stainless Steel Welded Cross-Bracing Legs w/ Adjustable Stainless Steel Bullet Feet
- 15A - 120V GFI Duplex Outlet Hidden Beneath Shelf
- **Side Panel Models** Include Removable Perforated Top w/ Drain & Front Apron; Units Are Supported By Side Panels & Do Not Require Legs



**CR-42X36-7-R**  
(Shown with optional Wrist Handles)



**CR-44X36SP-7-L**



GFI Duplex Receptacle Hidden Beneath Blender Shelf

Model #	Price	O.A. Length	Description	Ice Capacity	Approx. Weight	Approx. Cu. Ft.
<b>CR-42X36-7-L or R</b>	<b>\$6365</b>	42"	Stainless Steel Legs	210 lbs.	233 lbs.	45
<b>SIDE PANELS WITH PERFORATED DRAINBOARD SHELF</b>						
<b>CR-44x36SP-7-L or R</b>	<b>8180</b>	44"	Side Panels w/ Perforated Drbd. Shelf	210 lbs.	425 lbs.	68

*NOTE: To determine left or right hand model, Ice Bin is either Left (L) or Right (R) of the sink from the bartender side.*

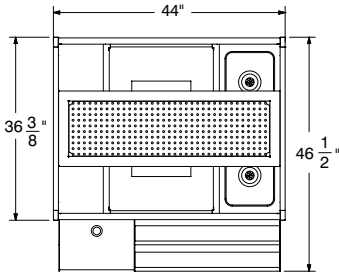

**CR-44X36SP-7-L**

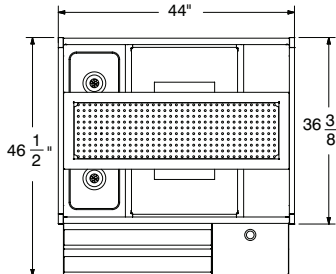

**CR-44X36SP-7-R**

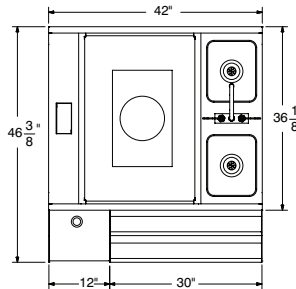

**CR-42X36-7-L**

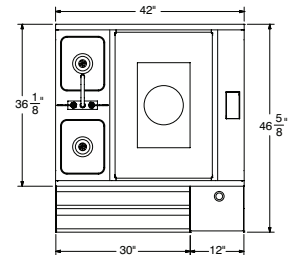

**CR-42X36-7-R**

**FOR ADDITIONAL OVERSHELVES OR GLASS RACKS, START WITH PRESTIGE PASS THRU WORK STATIONS PAGE 108**

### PASS-THRU ICE BIN 12" Deep



- 29" working height
- Insulated Ice Bin
- Stainless Steel Welded Cross-Braced Legs w/ Adjustable Stainless Steel Bullet Feet
- 210 lbs. Ice Bin Capacity
- **CRPT-2436-7** Includes 7-Circuit Cold Plate Sealed Into The Bottom Of Ice Bin

Model #	Price	Size W x L x H	Approx. Weight	Approx. Cu. Ft.
<b>CRPT-2436</b>	<b>\$2272</b>	36 1/4" x 24" x 29"	80 lbs.	13
<b>CRPT-2436-7</b>	<b>3634</b>	36 1/4" x 24" x 29"	115 lbs.	13

**ADDITIONAL SIZES AVAILABLE FOR SPECIALTY ICE BINS.**  
SU-61 Special Sizing to Reduce Length..... N/C

### SLIDING STAINLESS STEEL COVER For Pass-Thru Ice Bin



**SSC-PT \$335**

**For Full Line Of Ice Bin  
Accessories, See Page 116.**

**NSF** All Drainboards Are NSF Approved



SLD-3

- Embossed & Seamless Drainboard
- 4" Backsplash
- Galvanized Legs w/ Adjustable Galvanized Side Cross-Bracing & Adjustable Plastic Bullet Feet
- 1" IPS Drain
- CRD Series Has Rear Deck For Extra Storage

### FREE-STANDING BAR DRAINBOARDS 29" Working Height

Overall Length	18" WIDE			21" WIDE		
	Model	Price	Approx. Weight	Model	Price	Approx. Weight
12"	SLD-12	\$651	26 lbs.	CRD-12	\$726	28 lbs.
18"	SLD-18	717	29 lbs.	CRD-18	820	30 lbs.
24"	SLD-2	836	35 lbs.	CRD-2	890	39 lbs.
30"	SLD-30	886	40 lbs.	CRD-30	1008	41 lbs.
36"	SLD-3	971	42 lbs.	CRD-3	1067	47 lbs.
48"	SLD-4	1151	55 lbs.	CRD-4	1240	51 lbs.

### MAKE 24" CORNER DRAINBOARDS

Add to SLD-2 or CRD-2 Drainboards Only

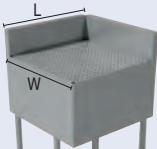

Model #	Price	W x L
SU-1824R or L	\$211	18" x 24"
SU-2124R or L	228	21" x 24"

Add SU-40 To Prep Unit For Speed Rail Installation - \$75

### RECESSED BAR DRAINBOARDS Holds Multiple Tiers Of Glasses • 23 1/2" Working Height



SL-GS-12 Shown  
23" Wide Units



CR-GS-18 shown  
26" Wide Units

- Includes Four Galvanized Legs w/ Adjustable Galvanized Side Cross-Bracing & Adjustable Plastic Bullet Feet
- Embossed And Seamless Drainboard
- 1" IPS Drain Centered In Drainboard
- CR-GS Series Has Rear Deck For Extra Storage

Overall Length	23" WIDE			26" WIDE		
	Model	Price	Approx. Weight	Model	Price	Approx. Weight
12"	SL-GS-12	\$606	20 lbs.	CR-GS-12	\$689	20 lbs.
15"	SL-GS-15	640	22 lbs.	CR-GS-15	703	22 lbs.
18"	SL-GS-18	697	24 lbs.	CR-GS-18	755	24 lbs.
24"	SL-GS-24	778	28 lbs.	CR-GS-24	863	28 lbs.

### SPECIALTY BAR DRAINBOARDS

#### Beer Drainer

Features A 3" x 6" Rear Column For Beer Lines  
26" Working Height



CRBD-2

- 7" Backsplash
- Embossed And Seamless Drainboard
- Galvanized Legs w/ Adjustable Plastic Bullet Feet
- Adjustable Galvanized Side Cross-Bracing
- 1" IPS Drain Centered In Drainboard

#### Frozen Drink Machine Stands

10-1/2" Working Height



SCFD-18

- 14" Backsplash
- Features A Lower Working Height To Accommodate The Height Of Most Drink Machines For Underbar Use
- Beveled Front
- Drain Centered In Back Of Unit
- Galvanized Legs w/ Adjustable Plastic Bullet Feet
- Adjustable Galvanized Side Cross-Bracing

L	18" WIDE			21" WIDE		
	Model	Price	Wt.	Model	Price	Wt.
18"	SLBD-18	\$1086	32 lbs.	CRBD-18	\$1239	33 lbs.
24"	SLBD-2	1204	38 lbs.	CRBD-2	1297	42 lbs.

**SCFD-18 \$1012**  
18" x 28" x 33"  
Holds One Drink Machine  
45 lbs. 10 Cu. Ft.

**SCFD-30 \$1515**  
30" x 28" x 33"  
Holds Two Drink Machines  
80 lbs. 18 Cu. Ft.

# BLENDER STATIONS

## Blender Stations & Uni-Serv Speed Bar

Underbar **BASICS™**

### BLENDER STATIONS

Includes Four Galvanized Legs w/ Adjustable Plastic Bullet Feet  
Featuring Adjustable Galvanized Side Cross-Bracing  
All Faucets Meet Federal Lead Free Standards



All Blender Stations Include A  
15A - 120V GFI Duplex Receptacle  
Hidden Beneath Blender Shelf

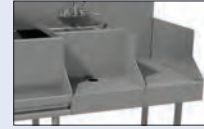

**WANT US TO CONNECT IT?**  
Add **SU-24**

Price Per Every Two Units **\$140**



### w/ Dump Sink & Faucet

- Dump Sink
- 4" Backsplash
- 15A - 120V GFI Duplex Outlet Hidden Beneath Shelf
- Recessed Step For Blenders
- Grommet Hole For Blender Power Cords
- 1" IPS Drain

- **SL-RS Series** Includes 4" O.C. Splash Mounted Swing Spout Faucet
- **CR-RS Series** Includes 4" O.C. Deck Mounted Swing Spout Faucet And Has Rear Deck For Extra Storage

**SL-RS Series**  
23" Wide Units With  
Splash Mount Faucet

**CR-RS Series**  
26" Wide Units With  
Deck Mount Faucet

Overall Length	23" WIDE	Price	Approx. Weight	Approx. Cu. Ft.	26" WIDE	Price	Approx. Weight	Approx. Cu. Ft.
12"	<b>SL-RS-12</b>	<b>\$952</b>	20 lbs.	6	<b>CR-RS-12</b>	<b>\$1022</b>	21 lbs.	6
18"	<b>SL-RS-18</b>	<b>1092</b>	23 lbs.	6	<b>CR-RS-18</b>	<b>1138</b>	23 lbs.	6



### Double Step Blender Station

- Features Two Blender Stations For High Volume Mixing Areas
- 15A - 120V GFI Duplex Outlet Hidden Beneath Shelf
- Grommet Hole For Blender Power Cords
- 4" Backsplash
- **CR-DB Series** Has Rear Deck For Extra Storage

**NOTE:**  
Blender Stations Can  
Not Accommodate  
A Speed Rail

**SL-DB Series**  
23" Wide Units

**CR-DB Series**  
26" Wide Units

Overall Length	23" WIDE	Price	Approx. Weight	Approx. Cu. Ft.	26" WIDE	Price	Approx. Weight	Approx. Cu. Ft.
12"	<b>SL-DB-12</b>	<b>\$635</b>	20 lbs.	6	<b>CR-DB-12</b>	<b>\$686</b>	21 lbs.	6
18"	<b>SL-DB-18</b>	<b>721</b>	21 lbs.	6	<b>CR-DB-18</b>	<b>744</b>	22 lbs.	6

### BLENDER STATION ACCESSORIES & MODIFICATIONS

<b>A-15</b>	Chrome Towel Ring (Packed Loose)	.....	<b>\$96</b>
<b>A-16</b>	Perforated Basket (Fits 10" x 14" x 10" Sink)	.....	<b>239</b>
<b>A-17</b>	Perforated Basket (Fits 9-1/2" x 11-1/2" x 6 Sink)	.....	<b>234</b>
<b>K-316-LU</b>	Add Wrist Handles	.....	<b>114</b>
<b>SU-10A</b>	18" Stainless Steel Leg Upgrade (Set of 4 -Includes Adjustable Front-to-Back Cross-Bracing)	.....	<b>243</b>

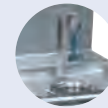

### Add A Liquid Waste Chute

- 5-1/2" Diameter Liquid Waste Chute
- Includes K-54 Push-Back Water Filler Faucet

**SU-36 \$833**

### UNI-SERV SPEED BAR

12" Deep Ice Bin w/ Dump Sink, Recessed Drainboard & Blender Station • 29" Working Height

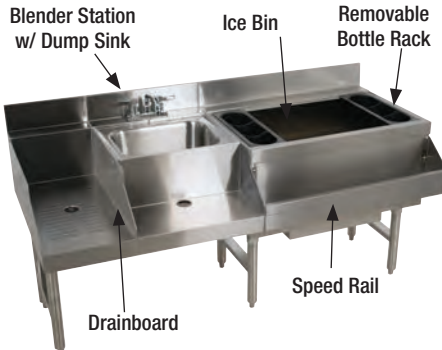

**CRU-60R Shown**

- 4" Backsplash
- 26" Front To Back
- SRK-30 - 30" Speed Rail
- 30" Insulated Ice Bin
- 98 lbs. Ice Bin Capacity
- Two Removable Plastic Bottle Racks
- Optional 7-Circuit Cold Plate Sealed Into The Bottom Of Ice Bin
- Dump Sink
- 4" O.C. Deck Mounted Swing Spout Faucet
- Recessed Drainboard for Glassware
- Dual Blender/Mixer Recess
- Galvanized Legs w/ Adjustable Plastic Bullet Feet & Adjustable Galvanized Side Cross-Bracing



15A - 120V GFI Duplex  
Receptacle Hidden  
Beneath Blender Shelf

Model #	Price	Overall Length	Approx. Weight	Approx. Cu. Ft.
<b>CRU-60L or R</b>	<b>\$3391</b>	60"	110 lbs.	23
<b>w/ 7-CIRCUIT COLD PLATE</b>				
<b>CRU-60L-7 or R-7</b>	<b>4753</b>	60"	193 lbs.	23

*L And R Indicate Ice Bin Location.*

### BEER BOX

18" Deep • 29" Working Height

- Perforated False Bottom Allows Melted Ice To Drain
- False Bottom Is Removable For Easy Cleaning
- 4" Backsplash
- Stainless Steel Legs w/ Adjustable Stainless Steel Bullet Feet
- 1" I.P.S. Drain



CRBB-48

Model #	Price	Overall Length	Ice Bin Liner Size W x L x H	Capacity of Bottled Beer	Approx. Weight	Approx. Cu. Ft.
CRBB-48	\$2229	48"	20 3/4" x 45 3/4" x 18"	12 cases	220 lbs.	14
CRBB-60	2386	60"	20 3/4" x 57 3/4" x 18"	18 cases	225 lbs.	15

### BEER BOX COVERS

Includes Two Padded Locks & Keys



*Beer Box Covers Must Be Removed During Normal Operation*

Model #	Description	Price
SU-35A	For 48" Beer Box	\$699
SU-35B	For 60" Beer Box	879

Add **SU-55** For Stainless Steel Divider - \$169 ea.

### LIQUOR DISPLAYS **NSF**

Tiered Steps & Retaining Bars Securely Display Liquor Bottles



LD-1824

### Liquor Display Rack

- Sound Deadened
- 4" Backsplash
- Galvanized Legs w/ Adjustable Plastic Bullet Feet
- Adjustable Galvanized Side Cross-Bracing
- 26" Wide Units Have Rear Deck For Extra Storage



CRLR-24

### Liquor Display Cabinet

- Stainless Steel Cabinet
- 4" Backsplash
- Stainless Steel Legs w/ Adjustable Bullet Feet

	Model #	Price	Overall Length	Approx. Bottle Capacity	Approx. Weight	Approx. Cu. Ft.
<b>23" WIDE</b>	LD-1812	\$997	12"	12	30 lbs.	15
	LD-1818	1102	18"	20	35 lbs.	20
	LD-1824	1332	24"	28	40 lbs.	30
<b>26" WIDE</b>	LD-2112	1090	12"	12	30 lbs.	15
	LD-2118	1230	18"	20	35 lbs.	20
	LD-2124	1396	24"	28	40 lbs.	30

	Model #	Price	Overall Length	Approx. Bottle Capacity	Approx. Weight	Approx. Cu. Ft.
<b>21" WIDE</b>	CRLR-12	\$1191	12"	15	35 lbs.	7
	CRLR-18	1267	18"	20	36 lbs.	10
	CRLR-24	1669	24"	30	42 lbs.	13
	CRLR-30	1728	30"	35	47 lbs.	14
	CRLR-36	1839	36"	45	50 lbs.	15

### REMOVABLE STAINLESS STEEL LIQUOR DISPLAY COVERS

Includes Padlock & Two Keys. Factory Installed Only.

#### Display Rack Cover

For LD Models Only



	Length	Model #	Price
<b>18" WIDE</b>	12"	LC-1812	\$504
	18"	LC-1818	559
	24"	LC-1824	616
<b>21" WIDE</b>	12"	LC-2112	543
	18"	LC-2118	599
	24"	LC-2124	677

#### Display Cabinet Cover

For CRLR Models Only



	Length	Model #	Price
<b>21" WIDE</b>	12"	LC-12	\$610
	18"	LC-18	660
	24"	LC-24	699
	30"	LC-30	782
	36"	LC-36	845

For Speed Rails, See Page 101.

# BAR STORAGE

## Glassware Storage

Glass Racks Not Included • Approximate Weights & Cubes Listed

### UNDERBAR STORAGE CAB

With Seamless & Embossed Drainboard Top

#### Drainboard Cabinets

- 21" Width (Front to Back)
- 4" Backsplash
- 1" IPS Drain In Back Right Corner Of Top
- 3" Diameter Drain Hole In Upper Right Corner Of Back Panel
- Stainless Steel Legs w/ Adjustable Bullet Feet



**OPEN BASE**  
CRD-2B Shown



**w/ MID-SHELF**  
CRD-2BM Shown



**W/ MID-SHELF & DOOR**  
CRD-2BMD Shown

Underbar **Basics™**

Size W x L x H	OPEN BASE		2 TIER STORAGE UNIT		2 TIER STORAGE UNIT WITH HINGED DOOR		Approx. Weight	Approx. Cu. Ft.
	Model #	Price	Model #	Price	Model #	Price		
21" x 24" x 33"	CRD-2B	\$1435	CRD-2BM	\$1666	CRD-2BMD	\$1748	59 lbs.	14
21" x 30" x 33"	CRD-30B	1504	CRD-30BM	1844	CRD-30BMD	2012	99 lbs.	18
21" x 36" x 33"	CRD-3B	1672	CRD-3BM	2018	CRD-3BMD	2185	140 lbs.	20
21" x 48" x 33"	CRD-4B	1816	CRD-4BM	2162	CRD-4BMD	2306	152 lbs.	20

#### 24" Glass Rack Storage Unit



CRCR-24-CT

- 21" Width (Front to Back)
- 4" Backsplash
- Holds Up To 3 Glass Racks
- Stainless Steel Glass Rack Slides
- 1" IPS Drain In Back Right Corner Of Top
- 3" Diameter Drain Hole In Upper Right Corner Of Back Panel
- Stainless Steel Legs w/ Adjustable Bullet Feet

52 lbs. 13 Cu. Ft.

**CRCR-24 \$1327**  
Flat Top - Drain Not Included  
**CRCR-24-CT \$1416**  
Corrugated Top

#### Cabinet w/ Dump Sink & Waste Chute



- 21" x 18" x 33"
- Includes 1 Hinged Door
- 9" x 9" x 4" Dump Sink
- 4" O.C. Splash Mounted Swing Spout Lead Free Compliant Faucet
- 5 1/2" Diameter Waste Chute
- Stainless Steel Legs w/ Adjustable Bullet Feet

64 lbs. 15 Cu. Ft.

**CRDW-18 \$2211**

**Shown With Optional Door Lock and Wrist Handle Faucet**

### CABINET MODIFICATIONS & ACCESSORIES



**Add A Sink - \$924**  
Splash Mount Faucet Included  
**SU-22A 10" x 14" x 10" Bowl**  
**SU-22C 9" x 9" x 4" Bowl**



**Add A Liquid Waste Chute With Filler Faucet**  
**SU-36 \$833**  
• 5 1/2" Dia. Liquid Waste Chute  
• Includes K-54 Push-Back Water Filler Faucet  
(Meets Federal Lead Free Standards)



**Add A Door Lock**  
**SU-27 \$286**  
• Includes 2 Keys



**Add A Dipperwell Only**  
**A-7 \$384**  
• 5 1/2" Diameter  
• 1-1/2" NPT Drain Connection  
• Factory Installed. Includes TA-34 Cutout

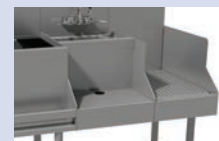

**WANT US TO CONNECT IT?**

**Add SU-24 \$140**  
Price Per Every Two Units

### STANDARD SPEED RAILS

#### Stainless Steel Speed Rails

- Keyhole Installation

SINGLE	Price	Size W x L x H	Bottle Capacity	Wt.	Cu. Ft.	DOUBLE	Price	Size W x L x H	Bottle Capacity	Wt.	Cu. Ft.
<b>BK-15</b>	<b>\$100</b>	4 1/2" x 15" x 5 1/2"	4	4 lbs.	1	<b>DT-15</b>	<b>\$187</b>	8 1/2" x 15" x 7"	8-10	7 lbs.	1
<b>BK-2</b>	<b>102</b>	4 1/2" x 24" x 5 1/2"	4-6	5 lbs.	1	<b>DT-2</b>	<b>191</b>	8 1/2" x 24" x 7"	10-12	8 lbs.	1
<b>BK-30</b>	<b>112</b>	4 1/2" x 30" x 5 1/2"	8-9	6 lbs.	1	<b>DT-30</b>	<b>205</b>	8 1/2" x 30" x 7"	16-18	10 lbs.	1
<b>BK-3</b>	<b>119</b>	4 1/2" x 36" x 5 1/2"	9-10	6 lbs.	1	<b>DT-3</b>	<b>215</b>	8 1/2" x 36" x 7"	18-20	11 lbs.	1
<b>BK-4</b>	<b>143</b>	4 1/2" x 48" x 5 1/2"	12-13	8 lbs.	1	<b>DT-4</b>	<b>260</b>	8 1/2" x 48" x 7"	24-26	18 lbs.	1

Single Tier  
BK-2 Shown



Double Tier  
DT-30 Shown



#### Black Plastic Speed Rails

- Injection Molded Black Plastic Construction
- Packed 6 Per Carton (Must Order Qty. of 6)
- Liquor Bottle Capacity = 5 Per Speed Rail

Model #	Price	Size W x L x H	Wt.	Cu. Ft.
<b>KS-2K</b>	<b>\$50</b>	4 1/8" x 23" x 5 3/8"	16 lbs.	2



Add Strap Hangers  
**PR-STRAP \$43**  
For KS-2K Only



### HEAVY DUTY STAINLESS STEEL SPEED RAILS

Keyhole Installation

#### Standard HD Speed Rails

SINGLE TIER  
SRK-2 Shown



DOUBLE TIER  
SRKD-18 Shown



SINGLE	Price	Size W x L x H	Cap.	DOUBLE	Price	Size W x L x H	Cap.	Wt. (lbs.)	Cu. Ft.
<b>SRK-12</b>	<b>\$134</b>	5 1/4" x 12" x 7 3/4"	3	<b>SRKD-12</b>	<b>\$230</b>	10 1/2" x 12" x 9 1/4"	6	8	1
<b>SRK-15</b>	<b>138</b>	5 1/4" x 15" x 7 3/4"	4	<b>SRKD-15</b>	<b>234</b>	10 1/2" x 15" x 9 1/4"	8	9	1
<b>SRK-18</b>	<b>140</b>	5 1/4" x 18" x 7 3/4"	4-5	<b>SRKD-18</b>	<b>272</b>	10 1/2" x 18" x 9 1/4"	8-10	10	1
<b>SRK-2</b>	<b>154</b>	5 1/4" x 24" x 7 3/4"	5-6	<b>SRKD-2</b>	<b>323</b>	10 1/2" x 24" x 9 1/4"	10-12	13	1
<b>SRK-30</b>	<b>156</b>	5 1/4" x 30" x 7 3/4"	7-8	<b>SRKD-30</b>	<b>369</b>	10 1/2" x 30" x 9 1/4"	14-16	16	1
<b>SRK-3</b>	<b>159</b>	5 1/4" x 36" x 7 3/4"	9-10	<b>SRKD-3</b>	<b>383</b>	10 1/2" x 36" x 9 1/4"	18-20	18	1
<b>SRK-42</b>	<b>154</b>	5 1/4" x 42" x 7 3/4"	11-12	<b>SRKD-42</b>	<b>396</b>	10 1/2" x 42" x 9 1/4"	22-24	20	2
<b>SRK-4</b>	<b>166</b>	5 1/4" x 48" x 7 3/4"	13-14	<b>SRKD-4</b>	<b>400</b>	10 1/2" x 48" x 9 1/4"	26-28	22	2
<b>SRK-5</b>	<b>180</b>	5 1/4" x 60" x 7 3/4"	15-18	<b>SRKD-5</b>	<b>459</b>	10 1/2" x 60" x 9 1/4"	30-36	26	2
<b>SRK-6</b>	<b>200</b>	5 1/4" x 72" x 7 3/4"	19-22	<b>SRKD-6</b>	<b>505</b>	10 1/2" x 72" x 9 1/4"	38-44	28	2
<b>SRK-7</b>	<b>233</b>	5 1/4" x 84" x 7 3/4"	23-26	<b>SRKD-7</b>	<b>567</b>	10 1/2" x 84" x 9 1/4"	46-52	30	2
<b>SRK-8</b>	<b>242</b>	5 1/4" x 96" x 7 3/4"	27-28	<b>SRKD-8</b>	<b>602</b>	10 1/2" x 96" x 9 1/4"	54-56	32	2

Make An Odd Length  
Speed Rail  
**SU-41 \$68**

Make Speed Rail Accommodate  
1/2 Gallon Bottles  
**SU-42 \$89**

#### Hang-On Style

- Removable
- Hangs On First Tier Of Any SRK Series Speed Rail
- Doubles Liquor Storage



Model #	Price	Size W x L x H	Cap.	Wt.	Cu. Ft.
<b>SR-12H</b>	<b>\$181</b>	6 1/4" x 12" x 8 1/2"	3	4 lbs.	1
<b>SR-15H</b>	<b>186</b>	6 1/4" x 15" x 8 1/2"	4	5 lbs.	1
<b>SR-18H</b>	<b>193</b>	6 1/4" x 18" x 8 1/2"	4-5	6 lbs.	1
<b>SR-2H</b>	<b>197</b>	6 1/4" x 24" x 8 1/2"	5-6	7 lbs.	1
<b>SR-30H</b>	<b>210</b>	6 1/4" x 30" x 8 1/2"	7-8	8 lbs.	1
<b>SR-3H</b>	<b>222</b>	6 1/4" x 36" x 8 1/2"	9-10	9 lbs.	1
<b>SR-42H</b>	<b>230</b>	6 1/4" x 42" x 8 1/2"	11-12	9 lbs.	2
<b>SR-4H</b>	<b>234</b>	6 1/4" x 48" x 8 1/2"	13-14	10 lbs.	2

Hang-On Style Speed Rails Are Not To Be Used  
With Any Other Manufacturer's Speed Rails

For Liquor Racks, See Page 99.



Actual Prestige Equipment Shown For Aroogas® Grille House & Sports Bar



**New Features and Benefits!**

*Perfect LINE UP Every Time!*



Removable Perforated  
Drainboards  
(Where Applies)

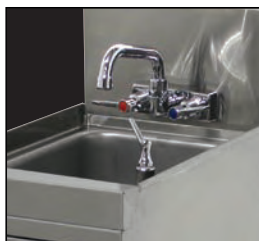

Stainless Steel Apron,  
Sides & Legs

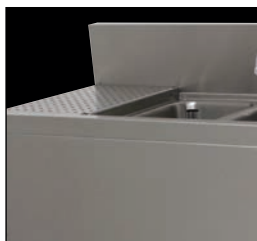

Available In  
Multiple Widths



7" High Backsplash  
with 1-3/4" Return



Adjustable Stainless Steel  
Side Cross-Bracing



Ice Bins w/ Cold Plate  
Include Soda Gun Knockout



Bar Die System Available  
(See Page 99)

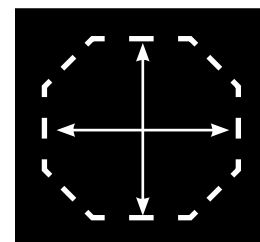

Floor Templates  
Available





# PRESTIGE *Signature Series*

## MODULAR BAR DIE SYSTEM

Exclusively For Advance Tabco's Prestige Bar Equipment

### Bartender's Side: 20 Gauge, 302 Stainless Steel

- Die Wall Can Be Sealed To The Floor, Eliminating Moisture In The Bar Structure.
- Recessed Equipment Outlets Allow Bar Equipment To Be Flush Against Bar Die Wall.
- GFI Outlets Set In Place (To Be Wired By Local Electrician To Meet Local Codes)
- Stainless Steel Panels Supplied Where Equipment By Others Is Located.
- Precise Engineering To Ensure An Exact Fit.
- Enclosed Casing For Beer Towers.
- Soda Gun Outlets Supplied (Location Must Be Specified).
- Cantilever System Made For Advance Tabco's Prestige Bar Equipment, Eliminating The Need For Legs.
- Pre-Defined Space For Plumbing And Drain Lines.

Bar Top And Drink Rail Can Be Fabricated From Equipment Drawings Ahead Of Time.

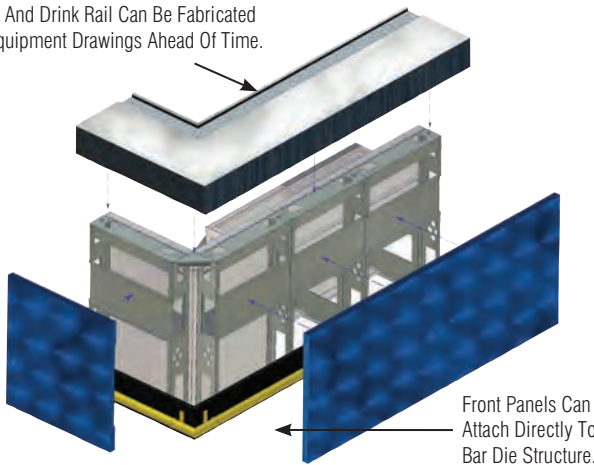



Front Panels Can Attach Directly To Bar Die Structure.

**Galvanized Bar Die Wall**  
Stainless Steel Exterior On Bar Side, Galvanized Upright Structure  
**Model # PR-BARDIE \$317 per foot**

---

**Stainless Steel Bar Die Wall**  
Stainless Steel Exterior On Bar Side, Stainless Steel Upright Structure  
**Model # PR-BARDIE-SS \$459 per foot**

For More Information, Contact Our SmartFab Department at 800-645-3166 or SmartFab@advancetabco.com.

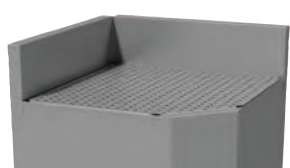
 <p><b>Flat Panel Section</b> w/ Recessed Outlet</p>	 <p><b>Ice Bin Section</b></p>	 <p><b>Cabinet Section</b></p>	<p><b>STAINLESS STEEL DRAINBOARD FILLERS</b></p> <p>Bolt On To Sides Of Equipment Multiple Angles Available • Optional Legs (See Page 110)</p> <p>Contact SmartFab Department For Details &amp; Pricing</p> 
---	---	--	---

## BAR DIE SYSTEM ACCESSORIES & MODIFICATIONS

Factory Installed Only - Except SU-BDB-100 (Supplied Loose For In Field Positioning)



**Recessed GFI Duplex Outlet**

**SU-62C \$480**



**Cool White LED Light 1.5 Watt **

- Single Box w/ Cover Plate
- Power Supply & Wiring Not Included

**SU-BDL-CW \$211 ea.**



**Receptacle Box Only**

**SU-62F \$63**



**LED Light Power Supply **

- 100 Watts
- Handles Up to 35 Lights

**SU-BDT-100 \$237 ea.**

## Floor Templates Available

**SU-82 Call For Price**



Templates Are Printed On Paper Rolls & Are Marked For Easy Alignment

# PRESTIGE Signature Series MODULAR BAR DIE SYSTEM

Exclusively For Advance Tabco's Prestige Bar Equipment

Contact Our SmartFab Department For Details  
800-645-3166 or SmartFab@advancetabco.com

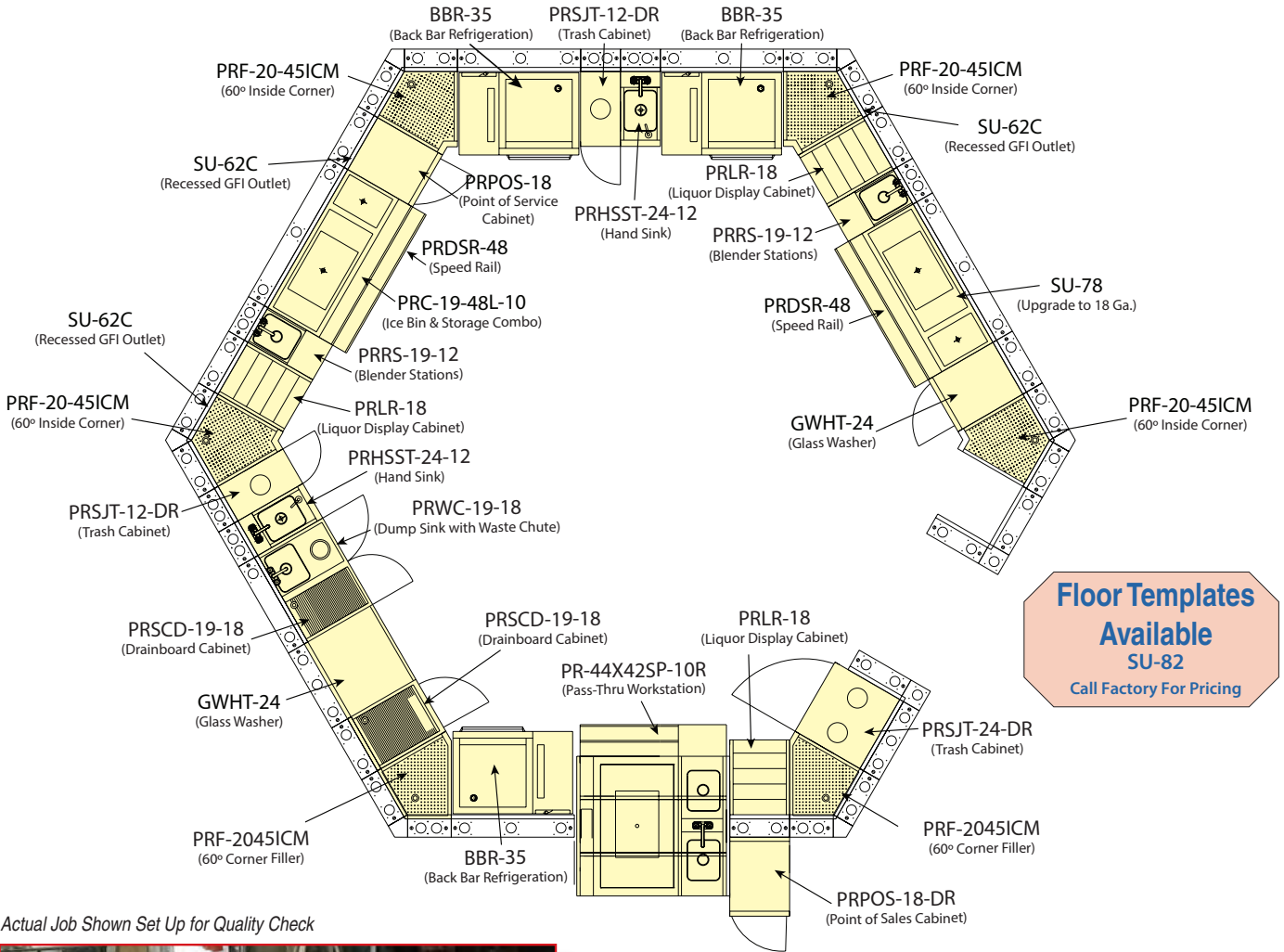

Floor Templates Available SU-82 Call Factory For Pricing

Actual Job Shown Set Up for Quality Check



Quality & Customer Satisfaction Is Our Top Priority!

Our factory takes the time to set up your entire Bar Die System to ensure all equipment properly fits and matches your specifications.

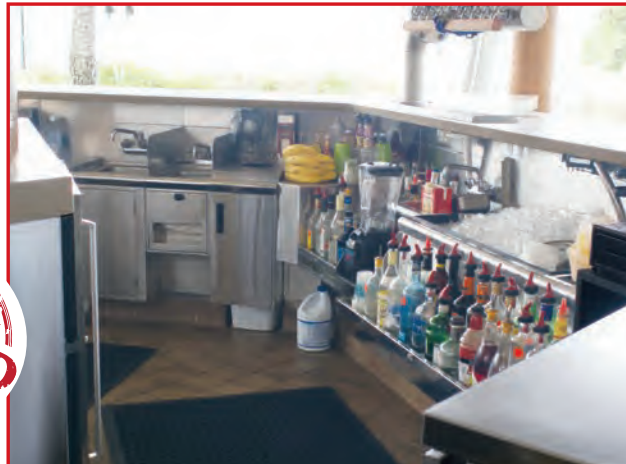

Shown with PRF-2045ICM Custom Filler & PLD-2518 Liquor Rack



## BAR HAND SINKS

29" Working Height

All Faucets Included Meet Federal Lead Free Standards

### Standard Bar Hand Sink



- **PRHS-19 Series** Includes 4" O.C. Splash Mt. Swing Spout Faucet
- **PRHS-24 Series** Includes 4" O.C. Deck Mt. Swing Spout Faucet & Has Rear Deck For Extra Storage

All Prestige Hand Sinks Feature:

- Deep Drawn Seamless Sink Bowl
- 1 1/2" IPS, 3 1/2" Basket Drain
- 7" Backsplash
- Stainless Steel Legs w/ Stainless Steel Adjustable Bullet Feet
- Adjustable Stainless Steel Side Cross-Bracing (Except PRHSC series)

L	w/ SPLASH MOUNT FAUCET				w/ DECK MOUNT FAUCET			
	20" WIDE	Price	Wt.	Cu.	25" WIDE	Price	Wt.	Cu.
12"	<b>PRHS-19-12</b>	<b>\$1165</b>	35 lbs.	8	<b>PRHS-24-12</b>	<b>\$1216</b>	28 lbs.	8
18"	<b>PRHS-19-18</b>	<b>1182</b>	40 lbs.	9	<b>PRHS-24-18</b>	<b>1232</b>	30 lbs.	9

PRHS-19-12 Shown

### Hand Sink w/ Soap & Towel Dispensers



- Deck Mount Soap Dispenser
- C-Fold Towel Dispenser
- **PRHSST-19 Series** Includes 4" O.C. Splash Mt. Swing Spout Faucet
- **PRHSST-24 Series** Includes K-124 Deck Mt. Faucet & Has Rear Deck For Extra Storage

L	w/ SPLASH MOUNT FAUCET				w/ DECK MOUNT FAUCET			
	20" WIDE	Price	Wt.	Cu.	25" WIDE	Price	Wt.	Cu.
12"	<b>PRHSST-19-12</b>	<b>\$1545</b>	53 lbs.	8	<b>PRHSST-24-12</b>	<b>\$1593</b>	58 lbs.	8
18"	<b>PRHSST-19-18</b>	<b>1561</b>	55 lbs.	9	<b>PRHSST-24-18</b>	<b>1609</b>	60 lbs.	9

PRHSST-24-12 Shown

### Hand Sink w/ Cabinet Base



- All Stainless Steel Cabinet Base
- Hinged Cabinet Door
- **PRHSC-19 Series** Includes 4" O.C. Splash Mt. Swing Spout Faucet
- **PRHSC-24 Series** Includes K-124 Deck Mt. Faucet & Has Rear Deck For Extra Storage

L	w/ SPLASH MOUNT FAUCET				w/ DECK MOUNT FAUCET			
	20" WIDE	Price	Wt.	Cu.	25" WIDE	Price	Wt.	Cu.
12"	<b>PRHSC-19-12</b>	<b>\$1728</b>	78 lbs.	9	<b>PRHSC-24-12</b>	<b>\$1794</b>	83 lbs.	10
18"	<b>PRHSC-19-18</b>	<b>1968</b>	80 lbs.	9	<b>PRHSC-24-18</b>	<b>2016</b>	85 lbs.	10

PRHSC-19-12 Shown

## HAND SINK ACCESSORIES & MODIFICATIONS



**Add Wrist Handles**  
Available For Splash or Deck Mount Faucets

**K-316-LU \$114**



**Chrome Towel Ring**  
Packed Loose

**A-15 \$96**



**Replacement Soap Deck Mount Dispenser**

**K-12 \$144**

<b>K-123</b>	Replacement Splash Mt. Faucet	<b>\$326</b>
<b>K-124</b>	Replacement Deck Mt. Faucet	<b>326</b>
<b>SU-73</b>	Add Mirror Finish <i>Factory Install Only</i>	<b>408</b>
<b>SU-74</b>	All Stainless Steel Construction Upgrade	<b>486</b>
<b>SU-75</b>	Add Welded Stainless Steel Cross-Bracing	<b>117</b>
<b>SU-20R or L</b>	Right or Left Side Splash for 20" Wide Unit	<b>179</b>
<b>SU-20RL</b>	Right & Left Side Splash for 20" Wide Unit	<b>375</b>
<b>SU-25R or L</b>	Right or Left Side Splash for 25" Wide Unit	<b>213</b>
<b>SU-25RL</b>	Right & Left Side Splash for 25" Wide Unit	<b>402</b>

For Our Full Line Of Accessories & Modifications, See Pages 116-118.

# PRESTIGE *Signature Series* Underbar Sinks

Featuring **Deep Drawn Seamless Sink Bowls**

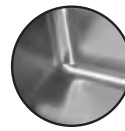

All Faucets Included Meet Federal Lead Free Standards

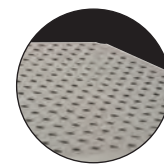

Featuring **Perforated Drainboard**

## BAR SINKS

Featuring 10" x 14" x 10" Deep Drawn Seamless Bowls & 29" Working Height

- 7" High Backsplash
- Removable Perforated Drainboard Top
- 9" Overflow Pipe w/ 1 1/2" IPS Drain Included Per Sink Bowl
- Sound Deadened
- Stainless Steel Top, Apron, Sides
- Stainless Steel Legs w/ Adjustable Stainless Steel Bullet Feet
- Adjustable Stainless Steel Side Cross-Bracing
- **PRB-19 Series** Includes 1 - 4" O.C. Splash Mounted Swing Spout Faucet
- **PRB-24 Series** Includes 1 - 4" O.C. Deck Mounted Swing Spout Faucet & Has Rear Deck For Extra Storage



**PRB-19 Series with Drainboards Shown**

20" Wide Units Include Splash Mount Faucet(s)



**PRB-24 Series**

25" Wide Units With Deck Mount Faucets

**NSF** All Sinks Are NSF Approved

*L And R Indicate Sink Location. C Indicates Sink Is Centered.*

	w/ SPLASH MOUNT FAUCET			w/ DECK MOUNT FAUCET			O.A. Length	# of Drbds.	Drbd. Length	Approx. Weight	Approx. Cu. Ft.
	20" WIDE	Price	Spout Length	25" WIDE	Price	Spout Length					
<b>1 COMP.</b>	PRB-19-31C	\$1719	6"	PRB-24-31C	\$1815	6"	36"	2	12"	89 lbs.	12
<b>2 COMP.</b>	PRB-19-22C	1725	6"	PRB-24-22C	1775	6"	24"	N/A	N/A	89 lbs.	8
	PRB-19-32LorR	1854	6"	PRB-24-32LorR	1930	6"	36"	1	11"	89 lbs.	12
	PRB-19-42LorR	1948	6"	PRB-24-42LorR	2051	6"	48"	1	23"	105 lbs.	16
	PRB-19-42C	1948	6"	PRB-24-42C	2051	6"	48"	2	12"	105 lbs.	16
<b>3 COMP.</b>	PRB-19-33C	2002	10"	PRB-24-33C	2069	12"	36"	N/A	N/A	105 lbs.	12
	PRB-19-43LorR	2277	10"	PRB-24-43LorR	2381	12"	48"	1	11"	107 lbs.	16
	PRB-19-53LorR	2486	10"	PRB-24-53LorR	2632	12"	60"	1	23"	125 lbs.	20
	PRB-19-53C	2548	10"	PRB-24-53C	2697	12"	60"	2	12"	125 lbs.	20
	PRB-19-63C	2680	10"	PRB-24-63C	2754	12"	72"	2	18"	143 lbs.	24
	PRB-19-73C	2785	10"	PRB-24-73C	2895	12"	84"	2	24"	190 lbs.	42
	PRB-19-83C	3317	10"	PRB-24-83C	3476	12"	96"	2	30"	176 lbs.	48
<b>4 COMP.</b>	PRB-19-44C*	2498	6"	PRB-24-44C*	2584	6"	48"	N/A	N/A	107 lbs.	16
	PRB-19-64C*	3051	6"	PRB-24-64C*	3157	6"	72"	2	12"	147 lbs.	24
	PRB-19-74C*	3165	6"	PRB-24-74C*	3291	6"	84"	2	18"	163 lbs.	42
	PRB-19-84C*	3733	6"	PRB-24-84C*	3893	6"	96"	2	24"	178 lbs.	48

\*4 Comp. Bar Sinks Include 2 - 6" Swing Spout Faucets

## BAR SINK ACCESSORIES & MODIFICATIONS

<b>SU-73</b> Add Mirror Finish (Factory Install Only)	<b>\$408</b>	<b>SU-20R or L</b> Right Or Left Side Splash For PRB-19 Series	<b>\$179</b>
<b>SU-74</b> All Stainless Steel Construction Upgrade	<b>486</b>	<b>SU-20RL</b> Right & Left Side Splash For PRB-19 Series	<b>375</b>
<b>SU-75</b> Add Welded Stainless Steel Cross-Bracing	<b>117</b>	<b>SU-25R or L</b> Right Or Left Side Splash For PRB-24 Series	<b>213</b>
<b>SU-79</b> Additional Drainboard Length	<b>136 Lin Ft.</b>	<b>SU-25RL</b> Right & Left Side Splash For PRB-24 Series	<b>402</b>

**PRI & PRC Series Feature:**

- Includes Two Removable Plastic Bottle Racks
- 1 3/4" Return w/ Soda Gun Knock Out (Cold Plate Models Only)
- 7" Backsplash

- Stainless Steel Top, Apron & Sides
- Stainless Steel Legs w/ Adjustable Stainless Steel Bullet Feet
- Adjustable Stainless Steel Side Cross-Bracing
- 1" IPS Drain (Non-Cold Plate Bin); 1/2" IPS Drain (Cold Plate Bin)
- **OPTIONAL** 10-Circuit Cold Plate Sealed Into The Bottom

# PRESTIGE Signature Series Ice Bins

**NSF** All Ice Bins Are NSF Approved

**All Bottle Racks Must Be Removed For NSF Compliance & For Use With Optional Cover**

*Quick Pour Bottles Not Included*

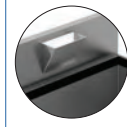

Soda Chase Provision (Tip-out)  
**SU-30 \$447**  
Only For Ice Bins w/ Backsplash



**PRC-19-48LR**



**PRI-19-24-10**

## ICE BINS 29" Working Height

- **PRI-24 Series** Has Rear Deck For Extra Storage

Ice Bin Depth	Overall Length	Ice Bin Capacity	20" WIDE	Price	25" WIDE	Price	Approx. Weight	Approx. Cu. Ft.
<b>11" DEEP</b>	12"	32 lbs.	<b>PRI-19-12</b>	<b>\$889</b>	<b>PRI-24-12</b>	<b>\$929</b>	45 lbs.	11
	24"	70 lbs.	<b>PRI-19-24</b>	<b>1124</b>	<b>PRI-24-24</b>	<b>1183</b>	70 lbs.	11
	30"	89 lbs.	<b>PRI-19-30</b>	<b>1306</b>	<b>PRI-24-30</b>	<b>1378</b>	75 lbs.	15
	36"	108 lbs.	<b>PRI-19-36</b>	<b>1382</b>	<b>PRI-24-36</b>	<b>1495</b>	80 lbs.	15
	42"	127 lbs.	<b>PRI-19-42</b>	<b>1894</b>	<b>PRI-24-42</b>	<b>2053</b>	85 lbs.	20
	48"	146 lbs.	<b>PRI-19-48</b>	<b>1984</b>	<b>PRI-24-48</b>	<b>2223</b>	90 lbs.	20
<b>15" DEEP</b>	24"	80 lbs.	<b>PRI-19-24-XD</b>	<b>1826</b>	<b>PRI-24-24-XD</b>	<b>1876</b>	85 lbs.	20
	30"	121 lbs.	<b>PRI-19-30-XD</b>	<b>1940</b>	<b>PRI-24-30-XD</b>	<b>1998</b>	90 lbs.	27
	36"	147 lbs.	<b>PRI-19-36-XD</b>	<b>2071</b>	<b>PRI-24-36-XD</b>	<b>2134</b>	95 lbs.	37
w/ 10-CIRCUIT COLD PLATE								
<b>11" DEEP</b>	24"	70 lbs.	<b>PRI-19-24-10</b>	<b>2392</b>	<b>PRI-24-24-10</b>	<b>2416</b>	140 lbs.	18
	30"	89 lbs.	<b>PRI-19-30-10</b>	<b>2535</b>	<b>PRI-24-30-10</b>	<b>2649</b>	173 lbs.	24
	36"	108 lbs.	<b>PRI-19-36-10</b>	<b>2698</b>	<b>PRI-24-36-10</b>	<b>2763</b>	150 lbs.	24
	42"	127 lbs.	<b>PRI-19-42-10</b>	<b>2999</b>	<b>PRI-24-42-10</b>	<b>3100</b>	155 lbs.	31
	48"	146 lbs.	<b>PRI-19-48-10</b>	<b>3683</b>	<b>PRI-24-48-10</b>	<b>3924</b>	160 lbs.	31
<b>15" DEEP</b>	24"	80 lbs.	<b>PRI-19-24-10-XD</b>	<b>2881</b>	<b>PRI-24-24-10-XD</b>	<b>2891</b>	165 lbs.	20
	30"	121 lbs.	<b>PRI-19-30-10-XD</b>	<b>3084</b>	<b>PRI-24-30-10-XD</b>	<b>3164</b>	175 lbs.	27
	36"	147 lbs.	<b>PRI-19-36-10-XD</b>	<b>3226</b>	<b>PRI-24-36-10-XD</b>	<b>3835</b>	175 lbs.	27

## ICE BIN & BOTTLE STORAGE COMBO 11" Deep Insulated Ice Bin • 29" Working Height

- Welded Partition Between Bins
- **PRC-24 Series** Has Rear Deck For Extra Storage

*L And R Indicate Ice Bin Location On Either Right Or Left Side. LR Indicates Ice Bin Is Centered.*

Overall Length	# Of Independent Bins	Ice Bin Capacity	20" WIDE	Price	25" WIDE	Price	Approx. Weight	Approx. Cu. Ft.
36"	2	70/32 lbs.	<b>PRC-19-36L or R</b>	<b>\$2239</b>	<b>PRC-24-36L or R</b>	<b>\$2323</b>	105 lbs.	15
42"	2	89/32 lbs.	<b>PRC-19-42L or R</b>	<b>2397</b>	<b>PRC-24-42L or R</b>	<b>2502</b>	110 lbs.	20
48"	2	108/32 lbs.	<b>PRC-19-48L or R</b>	<b>2562</b>	<b>PRC-24-48L or R</b>	<b>2685</b>	120 lbs.	20
48"	3	32/70/32 lbs.	<b>PRC-19-48LR</b>	<b>3147</b>	<b>PRC-24-48LR</b>	<b>3280</b>	160 lbs.	22
54"	3	32/89/32 lbs.	<b>PRC-19-54LR</b>	<b>3263</b>	<b>PRC-24-54LR</b>	<b>3397</b>	165 lbs.	27
60"	3	32/108/32 lbs.	<b>PRC-19-60LR</b>	<b>3394</b>	<b>PRC-24-60LR</b>	<b>3534</b>	170 lbs.	27
w/ 10-CIRCUIT COLD PLATE								
36"	2	70/32 lbs.	<b>PRC-19-36L-10 or R-10</b>	<b>3935</b>	<b>PRC-24-36L-10 or R-10</b>	<b>4025</b>	165 lbs.	24
42"	2	89/32 lbs.	<b>PRC-19-42L-10 or R-10</b>	<b>4223</b>	<b>PRC-24-42L-10 or R-10</b>	<b>4202</b>	175 lbs.	31
48"	2	108/32 lbs.	<b>PRC-19-48L-10 or R-10</b>	<b>4259</b>	<b>PRC-24-48L-10 or R-10</b>	<b>4380</b>	185 lbs.	33
48"	3	32/70/32 lbs.	<b>PRC-19-48LR-10</b>	<b>4848</b>	<b>PRC-24-48LR-10</b>	<b>4979</b>	195 lbs.	33
54"	3	32/89/32 lbs.	<b>PRC-19-54LR-10</b>	<b>4963</b>	<b>PRC-24-54LR-10</b>	<b>5097</b>	200 lbs.	40
60"	3	32/108/32 lbs.	<b>PRC-19-60LR-10</b>	<b>5090</b>	<b>PRC-24-60LR-10</b>	<b>5235</b>	205 lbs.	40

*\*Reverse Ice Bin Capacities For L or R Models.*

**WANT TO UPGRADE? Add SU-74 For All Stainless Steel Construction: \$486**

**For Prestige Ice Bin Covers, See Page 117.**

# PRESTIGE Signature Series

## Pass-Thru Units & Service Cabinet

### PASS-THRU WORKSTATION **NSF**

With Two Deep Drawn Sink Bowls • 29" Working Height

- Stainless Steel Top & Sides
- Blender Shelf With Duplex Outlet Hidden Underneath
- Double Tier Speed Rail
- Tubing Chase For Soda Gun
- 15A - 120V GFI Duplex Outlet Hidden Beneath Shelf
- 4" O.C. Deck Mounted Lead Free Compliant Swing Spout Faucet
- Insulated Ice Bin w/ 10-Circuit Cold Plate Sealed Into Bottom

- Stainless Steel Legs w/ Adjustable Stainless Steel Bullet Feet & Welded Cross-Bracing
- **Side Panel Models** Include Removable Perforated Top w/ Drain & Front Apron; Units Are Supported By Side Panels & Do Not Require Legs



GFI Duplex Receptacle Hidden Beneath Blender Shelf



PR-44X42SP-10-L

Model #	Price	O.A. Length	Description	Ice Capacity	Approx. Weight	Approx. Cu. Ft.
PR-42X30-10-L or R	\$5252	42"	Stainless Steel Legs	70 lbs.	250 lbs.	38
PR-42X42-10-L or R	8707	42"	Stainless Steel Legs	174 lbs.	400 lbs.	58
<b>SIDE PANELS WITH PERFORATED DRAINBOARD SHELF</b>						
PR-44X30SP-10-L or R	7415	44"	Side Panels w/ Perforated Drbd. Shelf	70 lbs.	350 lbs.	59
PR-44X42SP-10-L or R	12500	44"	Side Panels w/ Perforated Drbd. Shelf	174 lbs.	575 lbs.	88

#### Dual Soda Gun Holder

- Openings for a single soda gun on each end
  - Fits Prestige® Pass-Thru Workstations Only
- SU-43 \$948**  
Factory Installed Only

*NOTE: To determine left or right hand model, Ice Bin is either Left (L) or Right (R) of the sink from the bartender side.*

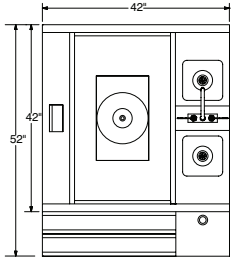

PR-42X42-10-L Shown

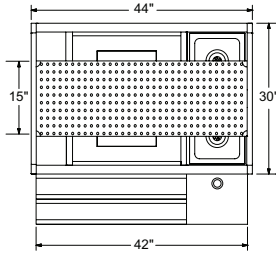

PR-44X30SP-10-L Shown

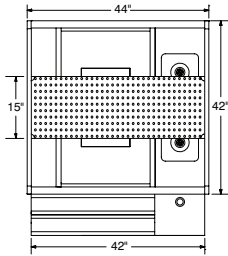

PR-44X42SP-10-L Shown

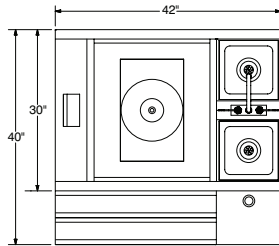

PR-42X30-10-L Shown

### OVERSHELVES FOR PASS-THRU WORKSTATIONS

(For SP Models Only - Factory Installed)

- 44" Wide x 16 3/4" Length
- Removable Perforated Pans
- Square Stainless Steel Posts
- 20 Gauge, 300 Stainless Steel

#### -G Models:

- Include Stemware Glass Rack
- 18 Gauge, 302 Stainless Steel
- Stainless Steel Shelf With Splash On Three Sides



Single Shelf  
PRSO-44-G Shown

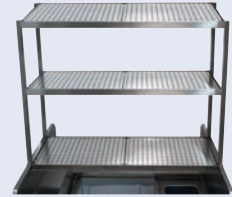

Double Shelf  
PRDO-44 Shown

Model #	Price	Description	Wt.	Cu. Ft.
PRSO-44	\$1174	Single Overshelf	65 lbs.	5
PRSO-44-G	1679	Single Overshelf w/ Stemware Glass Rack	85 lbs.	5
PRDO-44	2040	Double Overshelf	125 lbs.	17
PRDO-44-G	2776	Double Overshelf w/ Stemware Glass Rack	145 lbs.	17

### PASS-THRU ICE BINS **NSF**

11" Deep Insulated Ice Bin • 29" Working Height



Shown With Optional Speed Rail

- Stainless Steel Top, Apron, Sides & Legs w/ Adjustable Stainless Steel Bullet Feet
- Adjustable Stainless Steel Side Cross-Bracing
- PRPT-2442-10 Has 10-Circuit Cold Plate Sealed Into The Bottom

For Sliding Stainless Steel Covers, See Page 117

Model #	Price	Size W x L x H	Ice Capacity	Wt.	Cu. Ft.
PRPT-2442	\$2309	42" x 24" x 29"	174 lbs.	80 lbs.	13
PRPT-2442-10	4012	42" x 24" x 29"	174 lbs.	150 lbs.	13

### BEER BOX **NSF**

18" Deep • 29" Working Height

- Perforated False Bottom Allows Melted Ice To Drain
- Removable False Bottom
- Stainless Steel Legs w/ Stainless Steel Bullet Feet
- 7" Backsplash



PRBB-48

Model #	Price	Size W x L x H	Capacity Of Bottle Beer	Wt.	Cu. Ft.
PRBB-48	\$2838	25" x 48" x 33"	12 Cases	220 lbs.	14
PRBB-60	3043	25" x 60" x 33"	18 Cases	225 lbs.	15

#### BEER BOX LOCKING COVERS

Includes Padlock & 2 Keys

SU-35C 48" Cover \$755

SU-35D 60" Cover 935

Add Stainless Steel Dividers  
SU-55 \$160 ea.

*Beer Box Covers Must Be Removed During Normal Operation*

**PRD & PRGS Series Feature:**

- Removable Perforated Drainboard Top
- Stainless Steel Top, Sides & Legs w/ Adjustable Stainless Steel Bullet Feet
- Adjustable Stainless Steel Side Cross-Bracing
- 7" Backsplash
- 1" IPS Drain
- Sound Deadened

**Underbar Drainboards**

**DRAINBOARDS**

**29" Working Height**

- Stainless Steel Apron
- **PRD-24 Series** has Rear Deck For Extra Storage

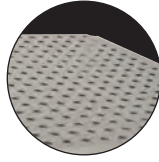

Removable Perforated Drainboard Top



All Drainboards Are NSF Approved

L	20" WIDE	Price	Approx. Weight	Approx. Cu. Ft.	25" WIDE	Price	Approx. Weight	Approx. Cu. Ft.
12"	<a href="#">PRD-19-12</a>	<b>\$836</b>	38 lbs.	8	<a href="#">PRD-24-12</a>	<b>\$896</b>	45 lbs.	10
18"	<a href="#">PRD-19-18</a>	<b>859</b>	45 lbs.	8	<a href="#">PRD-24-18</a>	<b>939</b>	52 lbs.	10
24"	<a href="#">PRD-19-24</a>	<b>928</b>	52 lbs.	8	<a href="#">PRD-24-24</a>	<b>1020</b>	59 lbs.	10
30"	<a href="#">PRD-19-30</a>	<b>1024</b>	59 lbs.	12	<a href="#">PRD-24-30</a>	<b>1086</b>	66 lbs.	14
36"	<a href="#">PRD-19-36</a>	<b>1063</b>	65 lbs.	12	<a href="#">PRD-24-36</a>	<b>1165</b>	73 lbs.	14
42"	<a href="#">PRD-19-42</a>	<b>1239</b>	70 lbs.	16	<a href="#">PRD-24-42</a>	<b>1366</b>	79 lbs.	19
48"	<a href="#">PRD-19-48</a>	<b>1332</b>	75 lbs.	16	<a href="#">PRD-24-48</a>	<b>1388</b>	86 lbs.	19



**PRD-19 Series**  
20" Wide Units



**PRD-24 Series**  
25" Wide Units

**RECESSED DRAINBOARDS**

**Holds Multiple Tiers Of Glassware • 18" Working Height**

- 14" Side Splashes
- **PRGS-24 Series** has Rear Deck For Extra Storage

L	25" WIDE	Price	Approx. Weight	Approx. Cu. Ft.	30" WIDE	Price	Approx. Weight	Approx. Cu. Ft.
12"	<a href="#">PRGS-19-12</a>	<b>\$732</b>	40 lbs.	8	<a href="#">PRGS-24-12</a>	<b>\$828</b>	45 lbs.	10
18"	<a href="#">PRGS-19-18</a>	<b>767</b>	45 lbs.	8	<a href="#">PRGS-24-18</a>	<b>830</b>	52 lbs.	10
24"	<a href="#">PRGS-19-24</a>	<b>824</b>	52 lbs.	8	<a href="#">PRGS-24-24</a>	<b>882</b>	59 lbs.	10
30"	<a href="#">PRGS-19-30</a>	<b>905</b>	59 lbs.	12	<a href="#">PRGS-24-30</a>	<b>991</b>	66 lbs.	14



**PRGS-19 Series**  
25" Wide Units



**PRGS-24 Series**  
30" Wide Units

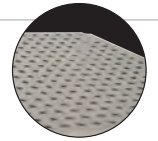

Removable Perforated Drainboard Top

**WANT TO UPGRADE?** Add [SU-74](#) For All Stainless Steel Construction **\$486**

**SPECIALTY DRAINBOARDS**

**Beer Drainer**

**21 1/4" Working Height**



**PRBD-19-24**

- 3" x 6" Rear Column For Beer Lines
- Removable Perforated Drainboard Top
- Stainless Steel Top, Apron, Sides & Legs w/ Adjustable Stainless Steel Bullet Feet
- Adjustable Stainless Steel Side Cross-Bracing
- 1" IPS Drain
- 14 3/4" Backsplash

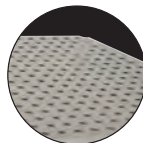

Removable Perforated Drainboard Top

L	20" WIDE	Price	Wt.	Cu. Ft.
18"	<a href="#">PRBD-19-18</a>	<b>\$1253</b>	50 lbs.	7
24"	<a href="#">PRBD-19-24</a>	<b>1271</b>	57 lbs.	8

L	25" WIDE	Price	Wt.	Cu. Ft.
18"	<a href="#">PRBD-24-18</a>	<b>\$1319</b>	57 lbs.	7
24"	<a href="#">PRBD-24-24</a>	<b>1389</b>	64 lbs.	10

**Frozen Drink Machine Stands**

**21" Working Height**



**PRFD-18**

- Lower Working Height Accommodates The Height Of Most Drink Machines For Underbar Use
- Beveled Front
- Top Pitched To 1" IPS Drain
- Stainless Steel Top, Apron, Sides & Legs w/ Adjustable Stainless Steel Bullet Feet
- Adjustable Stainless Steel Side Cross-Bracing
- 15" Backsplash

L	30" WIDE	Price	Wt.	Cu. Ft.
18"	<a href="#">PRFD-18</a>	<b>\$1204</b>	57 lbs.	14
30"	<a href="#">PRFD-30</a>	<b>1701</b>	80 lbs.	20

**POINT OF SERVICE CABINET**



**PRPOS-18-DR**  
*Shown with Optional Door Lock*



- 25" Working Height
- 11" High Backsplash & Side Splashes
- Louvered Door w/ Flush Handle
- 2" Access Hole In Work Surface For Power Cord
- Stainless Steel Top, Apron, Sides & Legs w/ Adjustable Stainless Steel Bullet Feet

**LOCK IT UP!**  
Add A Door Lock [SU-27](#) **\$286**

L	25" WIDE	Price	Wt.	Cu. Ft.
18"	<a href="#">PRPOS-18-DR</a>	<b>\$2038</b>	60 lbs.	14
24"	<a href="#">PRPOS-24-DR</a>	<b>2278</b>	150 lbs.	20

## Underbar Corner Drainboard & Fillers

All Units On This Page Feature  
A Removable Perforated  
Drainboard Top

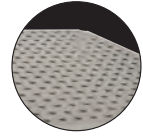

### 90° CORNER DRAINBOARD

Includes Stainless Steel Legs w/ Adjustable Stainless Steel Bullet Feet

- Free-Standing Corner Drainboard
- 7" High x 1-3/4" Thick Backsplash
- 1" I.P.S. Drain

Model #	Price	Size* (A) x (B)	Approx. Weight	Approx. Cu. Ft.
PRFD-2020	\$984	20" x 20"	68 lbs.	7
PRFD-2025	1041	20" x 25"	72 lbs.	12
PRFD-2030	1080	20" x 30"	78 lbs.	16
PRFD-2035	1169	20" x 35"	82 lbs.	16
PRFD-2520	1041	25" x 20"	69 lbs.	7
PRFD-2525	1091	25" x 25"	73 lbs.	12
PRFD-2530	1118	25" x 30"	79 lbs.	16
PRFD-2535	1226	25" x 35"	83 lbs.	16
PRFD-3020	1080	30" x 20"	78 lbs.	7
PRFD-3025	1118	30" x 25"	79 lbs.	12
PRFD-3030	1260	30" x 30"	82 lbs.	16
PRFD-3035	1320	30" x 35"	86 lbs.	16
PRFD-3520	1169	35" x 20"	82 lbs.	16
PRFD-3525	1226	35" x 25"	83 lbs.	16
PRFD-3530	1320	35" x 30"	86 lbs.	16
PRFD-3535	1393	35" x 35"	90 lbs.	16

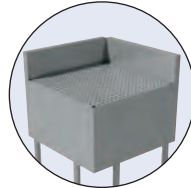

Includes Stainless Steel  
Legs w/ Adjustable  
Stainless Steel Bullet Feet

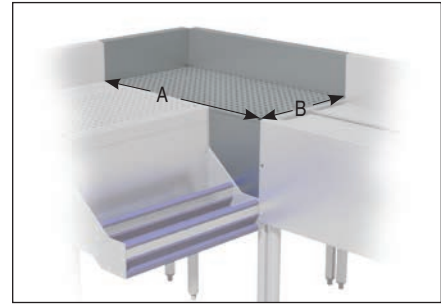

PRFD-3020

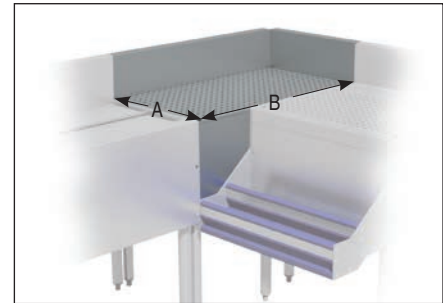

PRFD-2030

"A" represents the distance on the left side from the back wall until the front edge of the left unit.  
"B" represents the distance on the right side from the back wall until the front edge of the right unit.

### 90° CORNER FILLERS

- Must Be Bolted to Existing Line Up Equipment
- 7" High x 1-3/4" Thick Backsplash
- Available On Left or Right Side
- 1" I.P.S. Drain

#### Inside Corner

#### Outside Corner

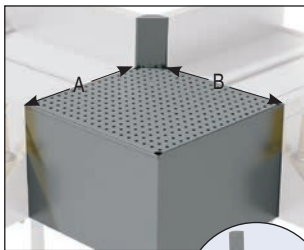
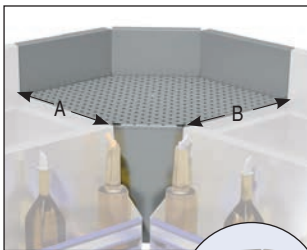

PRF-20-90IC Shown

PRF-20-90OC Shown

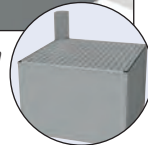

Model #	Price	Size (A) x (B)	Approx. Weight	Approx. Cu. Ft.
PRF-20-90IC or OC*	\$1052	20" x 20"	82 lbs.	16
PRF-25-90IC or OC*	1091	25" x 25"	84 lbs.	16

\* IC = Inside Corner OC = Outside Corner

### 45° CORNER FILLERS

- Must Be Bolted to Existing Line Up Equipment
- 7" High x 1-3/4" Thick Backsplash
- 1" I.P.S. Drain

#### Inside Corner

#### Outside Corner

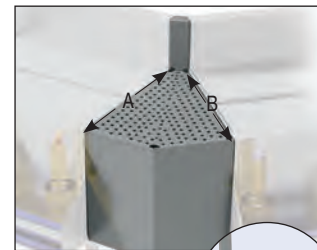
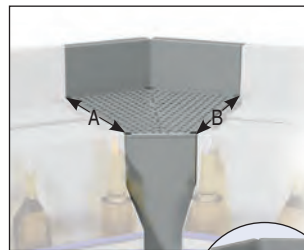

PRF-20-45IC Shown

PRF-20-45OC Shown

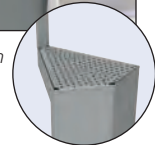
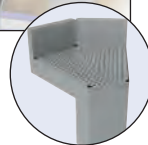

Model #	Price	Size (A) x (B)	Approx. Weight	Approx. Cu. Ft.
PRF-20-45IC or OC*	\$806	20" x 20"	82 lbs.	16
PRF-25-45IC or OC*	890	25" x 25"	84 lbs.	16

\* IC = Inside Corner OC = Outside Corner

**PLEASE NOTE: FILLERS BUILT TO ORDER & CAN NOT BE RETURNED**

**OPTIONAL LEGS & CUSTOM SIZES AVAILABLE**  
Consult Factory For Details



# Blender Stations & Uni-Serv Speed Bar

## FREE-STANDING BLENDER STATIONS

Stainless Steel Top, Apron, Sides & Legs w/ Adjustable Stainless Steel Bullet Feet  
Adjustable Stainless Steel Side Cross-bracing



15A - 120V GFI Duplex Receptacle Hidden Beneath Blender Shelf



**PRRS-19 Series**  
25" Wide Units With  
Splash Mount Faucet



**PRRS-24 Series**  
30" Wide Units With  
Deck Mount Faucet

### w/ Deep Drawn Sink

- Deep Drawn Sink
- Recessed Step w/ Grommet Hole For Blenders
- 7" Backsplash
- 3 1/2" Basket Drain w/ 1 1/2" IPS
- Sound Deadened
- **PRRS-19 Series** Includes 4" O.C. Splash Mounted Swing Spout Faucet
- **PRRS-24 Series** Includes 4" O.C. Deck Mounted Swing Spout Faucet & Has Rear Deck For Extra Storage

Overall Length	w/ SPLASH MT. FAUCET				w/ DECK MT. FAUCET			
	25" WIDE	Price	Approx. Weight	Approx. Cu. Ft.	30" WIDE	Price	Approx. Weight	Approx. Cu. Ft.
12"	<b>PRRS-19-12</b>	<b>\$1210</b>	49 lbs.	9	<b>PRRS-24-12</b>	<b>\$1327</b>	51 lbs.	9
18"	<b>PRRS-19-18</b>	<b>1298</b>	56 lbs.	9	<b>PRRS-24-18</b>	<b>1413</b>	58 lbs.	12



**PRDB-19 Series**  
25" Wide Units



**PRDB-24 Series**  
30" Wide Units

### w/ Drainboard

- Removable Perforated Drainboard Top
- Recessed Step w/ Grommet Hole For Blenders
- 7" Backsplash
- 1" IPS Drain
- Sound Deadened
- **PRDB-24 Series** Has Rear Deck For Extra Storage

Overall Length	25" WIDE				30" WIDE			
	Price	Approx. Weight	Approx. Cu. Ft.	Price	Approx. Weight	Approx. Cu. Ft.		
12"	<b>PRDB-19-12</b>	<b>\$812</b>	45 lbs.	9	<b>PRDB-24-12</b>	<b>\$899</b>	47 lbs.	9
18"	<b>PRDB-19-18</b>	<b>957</b>	50 lbs.	9	<b>PRDB-24-18</b>	<b>1054</b>	53 lbs.	12

**NOTE: Blender Stations Can Not Accommodate A Speed Rail**

### BLENDER STATION ACCESSORIES & MODIFICATIONS

- SU-73** Add Mirror Finish *Factory Install Only* ..... **\$408**
- SU-74** All Stainless Steel Construction Upgrade ..... **486**
- SU-75** Add Welded Stainless Steel Cross-Bracing ..... **117**



### Add A Liquid Waste Chute

- 5-1/2" Diameter Liquid Waste Chute
- Includes K-54 Push-Back Water Filler Faucet
- Perforated Drainboard Top Not Included

**SU-36 \$833**

## UNI-SERV SPEED BAR

Includes 30" Speed Rail • 7" Backsplash



**PRU-24-60R Shown**

- **48" Units:** 9" x 9" x 4" Deep Drawn Sink Bowl
- **60" Units:** 10" x 14" x 7" Deep Drawn Sink Bowl
- Recessed 18" Blender Station
- 3 1/2" Basket Drain
- Grommet Hole For Cord
- 30" x 11" Deep Insulated Ice Bin with Two Removable Plastic Bottle Racks
- Optional 10-Circuit Cold Plate Sealed Into The Bottom Of Ice Bin
- 1" I.P.S. Drain (1/2" I.P.S. Drain For Cold Plate Models)
- 7" Backsplash with 1 3/4" Return With Soda Gun Knock Out
- Recessed Drainboard with Removable Perforated Top with 1" I.P.S. Drain
- Stainless Steel Top, Apron, Sides & Legs with Stainless Steel Bullet Feet
- Adjustable Stainless Steel Side Cross-Bracing
- **PRU-19 Series:** 4" O.C. Splash Mounted Swing Spout Faucet
- **PRU-24 Series:** 4" O.C. Deck Mounted Swing Spout Faucet

L	25" WIDE			30" WIDE			Approx. Weight	Approx. Cu. Ft.
	O.A. Size	Price		O.A. Size	Price			
48"	<b>PRU-19-48LorR</b>	25"x48"	<b>\$3658</b>	<b>PRU-24-48LorR</b>	30"x48"	<b>\$4065</b>	135 lbs.	35
60"	<b>PRU-19-60LorR</b>	25"x60"	<b>4289</b>	<b>PRU-24-60LorR</b>	30"x60"	<b>4343</b>	135 lbs.	35

w/ 10-CIRCUIT COLD PLATE								
L	O.A. Size	Price	O.A. Size	Price	Approx. Weight	Approx. Cu. Ft.		
48"	<b>PRU-19-48L-10orR-10</b>	<b>4867</b>	25"x48"	<b>PRU-24-48L-10orR-10</b>	30"x48"	<b>5336</b>	170 lbs.	46
60"	<b>PRU-19-60L-10orR-10</b>	<b>5989</b>	25"x60"	<b>PRU-24-60L-10orR-10</b>	30"x60"	<b>6044</b>	170 lbs.	46

*L and R Indicate Ice Bin Location.*



15A - 120V GFI Duplex Receptacle Hidden Beneath Blender Shelf

# PRESTIGE Signature Series Underbar Cabinets

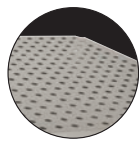

Removable Perforated Drainboard Top

**WARNING:** Equipment that includes a faucet may expose you to chemicals, including lead, that are known to the State of California to cause cancer or birth defects or other reproductive harm. For more Info., visit [www.p65warnings.ca.gov](http://www.p65warnings.ca.gov).

## DRAINBOARD CABINETS

All Stainless Steel Construction

- Sturdy Base Cabinet
- Removable Perforated Drainboard Top
- Removable Hinged Doors
- 7" Backsplash
- Stainless Steel Legs w/ Adjustable Stainless Steel Bullet Feet
- 1" IPS Drain
- Sound Deadened



All Drainboards Are NSF Approved



Open Base  
PRSCO-19-24 Shown



w/ Hinged Doors  
PRSCD-24-24 Shown

	L	25" WIDE	Price	Approx. Weight	Approx. Cu. Ft.	30" WIDE	Price	Approx. Weight	Approx. Cu. Ft.
OPEN BASE	12"	PRSCO-19-12	\$1257	48 lbs.	12	PRSCO-24-12	\$1376	55 lbs.	15
	18"	PRSCO-19-18	1372	55 lbs.	12	PRSCO-24-18	1491	62 lbs.	15
	24"	PRSCO-19-24	1526	62 lbs.	12	PRSCO-24-24	1636	69 lbs.	15
	30"	PRSCO-19-30	1814	69 lbs.	15	PRSCO-24-30	1924	76 lbs.	18
	36"	PRSCO-19-36	2091	75 lbs.	18	PRSCO-24-36	2204	82 lbs.	22
	42"	PRSCO-19-42	2357	80 lbs.	21	PRSCO-24-42	2467	90 lbs.	28
W/ HINGED DOORS	12"	PRSCD-19-12	1515	58 lbs.	12	PRSCD-24-12	1638	65 lbs.	15
	18"	PRSCD-19-18	1630	65 lbs.	12	PRSCD-24-18	1753	72 lbs.	15
	24"	PRSCD-19-24	1818	72 lbs.	12	PRSCD-24-24	1929	79 lbs.	15
	30"	PRSCD-19-30	2106	79 lbs.	15	PRSCD-24-30	2217	85 lbs.	18
	36"	PRSCD-19-36	2385	85 lbs.	18	PRSCD-24-36	2496	92 lbs.	22
	42"	PRSCD-19-42	2651	90 lbs.	21	PRSCD-24-42	2876	98 lbs.	28
48"	PRSCD-19-48	2940	95 lbs.	24	PRSCD-24-48	3047	102 lbs.	30	

### ADD MID-SHELF TO PRSCO SERIES \$447 /shelf

Add An "-M" After The Model Number  
(For example, PRSCO-19-18 would read PRSCO-19-18-M)

#### ADD A SINK (Includes Faucet)

10" x 14" x 10" **SU-22A \$924**  
9" x 9" x 4" **SU-22C \$924**

5 1/2" Stainless Steel Open Waste Chute

A-6  
\$309



Factory Installed

5 1/2" Dipperwell with Insert and Drain

A-7  
\$384



Factory Installed. Includes TA-34 Cutout

20" WIDE CABINETS AVAILABLE!

LOCK IT UP!

Use 25" Wide Model # & Add SU-77 \$83

Add A Door Lock SU-27 \$286

## W/ BUILT-IN DUMP SINK & WASTE CHUTE

All Stainless Steel Construction

- 9" x 9" x 4" Dump Sink
- 5-1/2" Diameter Waste Chute
- Optional Removable Hinged Doors w/ Lock
- 7" Backsplash
- Stainless Steel Legs w/ Adjustable Stainless Steel Bullet Feet
- PRWC-19 Series Includes 4" O.C. Splash Mt. Swing Spout Faucet
- PRWC-24 Series Includes 4" O.C. Deck Mt. Swing Spout Faucet & Has Rear Deck For Extra Storage

L	Style	w/ SPLASH MT. FAUCET		w/ DECK MT. FAUCET		Approx. Wt.	Approx. Cu. Ft.
		25" WIDE	Price	30" WIDE	Price		
18"	Open Base	PRWC-19-18	\$2038	PRWC-24-18	\$2080	62 lbs.	15
18"	w/ Hinged Door	PRWC-19-18-DR	2302	PRWC-24-18-DR	2345	67 lbs.	15



Open Base  
PRWC-19-18 Shown



w/ Hinged Door  
PRWC-19-18-DR Shown

## W/ STORAGE DRAWERS

All Stainless Steel Construction

- 6" Deep Drawers
- Removable Perforated Drainboard Top
- 1" IPS Drain
- 7" Backsplash
- Stainless Steel Legs w/ Adjustable Stainless Steel Bullet Feet



PR-25-DWR



PR-25-3DWR

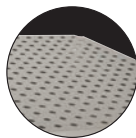

Removable Perforated Drainboard Top

L	Style	25" WIDE	Price	30" WIDE	Price	Wt.	Cu. Ft.
24"	1 Drawer & 1 Door	PR-25-DWR	\$2536	PR-30-DWR	\$3343	62 lbs.	15
24"	3 Drawers	PR-25-3DWR	2766	PR-30-3DWR	3689	85 lbs.	18

112 ADDITIONAL DRAINBOARD CABINET SIZES AVAILABLE - Consult Factory For Details

## ALL STAINLESS STEEL TRASH RECEPTACLES

Trash Bin Not Included

### 36" High Trash Receptacle Cabinet

- Open Bottom w/ Hinged Door
- Accommodates Slim Jim® Trash Can Measuring 11" x 20" x 25" (15 7/8 Gal. Cap.)
- S/S Legs w/ Adj. Stainless Steel Bullet Feet
- Overall Size: 12" x 25" x 36". 60 lbs. 9 Cu. Ft.



PRSJT-12-DR \$1557

### 19" High Trash Receptacle Cabinet

- Open Bottom w/ Hinged Door
- Units Mount Between Equipment Line Up
- Removable S/S Sliding Cover
- Overall Size: 12" x 25" x 21". 35 lbs. 4 Cu. Ft.



PRT-12 \$1268

### Trash Receptacle Cover

- Accommodates Slim Jim® Trash Can Measuring 11" x 20" x 25" (15 7/8 Gallon Capacity)
- Units Mount Between Equipment Line Up
- Overall Size: 12" x 25" x 9". 33 lbs. 4 Cu. Ft.



PRSJT-12 \$698

## Glassware & Liquor Storage

Glass & Liquor Racks Not Included

### GLASS RACK STORAGE CABINETS Featuring All Stainless Steel Construction

- Holds Up To 3 Glass Racks
- Adjustable Glass Rack Slides
- 7" Backsplash
- 1" IPS Drain On Bottom Shelf

- Stainless Steel Legs w/ Adjustable Stainless Steel Bullet Feet
- 30" Wide Units Have Rear Deck For Extra Storage



Open Top

PROR-24-24  
Shown



Drainboard Top

- Removable Perforated Drainboard Top
- 1" IPS Drain

PRCR-19-24  
Shown



Slanted Top

- Accommodates Liquor Rack On Slanted Top

PRSR-24-24  
Shown

Model #	Price	Size	Wt.	Cu.
PROR-19-24	\$1984	24" x 25" x 36"	50 lbs.	12
PROR-24-24	2072	24" x 30" x 36"	57 lbs.	12

Model #	Price	Size	Wt.	Cu.
PRCR-19-24	\$1528	24" x 25" x 36"	80 lbs.	16
PRCR-24-24	1645	24" x 30" x 36"	85 lbs.	17

Model #	Price	Size	Wt.	Cu.
PRSR-19-24	\$2165	24" x 25" x 36"	50 lbs.	12
PRSR-24-24	2256	24" x 30" x 36"	57 lbs.	12



Add Stainless Steel Full Extension Roller Slides

SU-46 \$913 /cabinet



Add Stainless Steel Concealing Drawer Front  
Requires SU-46

SU-47 \$457 /cabinet

### LIQUOR DISPLAYS

Tiered Steps & Retaining Bars Securely Display Liquor Bottles



PLD-2524



PRLR-24

#### Liquor Display Rack

- Retaining Bars Secure Bottles On Steps
- Sound Deadened
- 7" Backsplash
- Stainless Steel Top, Sides & Legs w/ Stainless Steel Bullet Feet
- Adjustable Stainless Steel Side Cross-Bracing
- 30" Wide Units Has Rear Deck For Extra Storage

	Model #	Price	Overall Length	Approx. Bottle Capacity	Approx. Weight	Approx. Cu. Ft.
25" WIDE	PLD-2512	\$1124	12"	15	25 lbs.	10
	PLD-2518	1201	18"	20	30 lbs.	10
	PLD-2524	1444	24"	30	35 lbs.	10
	PLD-2530	1554	30"	35	40 lbs.	14
	PLD-2536	1710	36"	45	50 lbs.	14
30" WIDE	PLD-3012	1288	12"	15	30 lbs.	12
	PLD-3018	1345	18"	20	35 lbs.	12
	PLD-3024	1455	24"	30	40 lbs.	12
	PLD-3030	1580	30"	35	45 lbs.	17
	PLD-3036	1740	36"	45	55 lbs.	17

#### Liquor Display Cabinet

- All Stainless Steel Construction
- 7" Backsplash
- Stainless Steel Legs w/ Adjustable Stainless Steel Bullet Feet

	Model #	Price	Overall Length	Approx. Bottle Capacity	Approx. Weight	Approx. Cu. Ft.
25" WIDE	PRLR-12	\$1334	12"	15	35 lbs.	7
	PRLR-18	1408	18"	20	36 lbs.	10
	PRLR-24	1476	24"	30	42 lbs.	13
	PRLR-30	1596	30"	35	47 lbs.	14
	PRLR-36	1759	36"	45	50 lbs.	15

### REMOVABLE STAINLESS STEEL LIQUOR DISPLAY COVERS

Includes Padlock & Two Keys



Display Rack Cover  
For PLD Models Only

	Length	Model #	Price
25" WIDE	12"	PRLC-2512	\$656
	18"	PRLC-2518	713
	24"	PRLC-2524	770
	30"	PRLC-2530	827
	36"	PRLC-2536	884
30" WIDE	12"	PRLC-3012	725
	18"	PRLC-3018	907
	24"	PRLC-3024	953
	30"	PRLC-3030	987
	36"	PRLC-3036	1021



Display Cabinet Cover  
For PRLR Models Only

	Length	Model #	Price
25" WIDE	12"	PRLC-12	\$793
	18"	PRLC-18	935
	24"	PRLC-24	1017
	30"	PRLC-30	1057
	36"	PRLC-36	1117

For Prestige Speed Rails, See Pages 114.

COVERS ARE FACTORY INSTALLED ONLY

## Speed Rails & Blender Shelves

### ALL STAINLESS STEEL SPEED RAILS

For Prestige Underbar Equipment

- Sound Deadened
- Bolt Holes For Mounting

Single & Double Tier Options Available



Single Tier  
PRSSR-36 Shown



Double Tier  
PRDSR-36 Shown

L	STANDARD SPEED RAILS						W/ LOCKING COVER Includes Keyed Lock						Approx. Wt.	Approx. Cu. Ft.
	SINGLE	Price	Cap.	DOUBLE	Price	Cap.	SINGLE	Price	Cap.	DOUBLE	Price	Cap.		
12"	PRSSR-12	\$184	3	PRDSR-12	\$288	6	PRSSR-12-LC	\$406	3	PRDSR-12-LC	\$621	6	8 lbs.	1
18"	PRSSR-18	197	4	PRDSR-18	359	8	PRSSR-18-LC	506	4	PRDSR-18-LC	820	8	10 lbs.	2
24"	PRSSR-24	212	6	PRDSR-24	424	12	PRSSR-24-LC	560	6	PRDSR-24-LC	942	12	12 lbs.	2
30"	PRSSR-30	227	7	PRDSR-30	487	14	PRSSR-30-LC	615	7	PRDSR-30-LC	1072	14	14 lbs.	3
36"	PRSSR-36	243	9	PRDSR-36	546	18	PRSSR-36-LC	669	9	PRDSR-36-LC	1187	18	14 lbs.	3
42"	PRSSR-42	256	10	PRDSR-42	614	20	PRSSR-42-LC	727	10	PRDSR-42-LC	1319	20	16 lbs.	4
48"	PRSSR-48	268	12	PRDSR-48	678	24	PRSSR-48-LC	782	12	PRDSR-48-LC	1446	24	16 lbs.	4
54"	PRSSR-54	286	13	PRDSR-54	745	26	NOT AVAILABLE						18 lbs.	5
60"	PRSSR-60	301	15	PRDSR-60	805	30							20 lbs.	5
72"	PRSSR-72	328	18	PRDSR-72	935	36							24 lbs.	6
84"	PRSSR-84	358	21	PRDSR-84	1062	42							28 lbs.	7
96"	PRSSR-96	387	24	PRDSR-96	1175	48							32 lbs.	8

### Hang-On Style Speed Rails

- Designed To Hang-on The First Tier Of Any PRSSR Series Speed Rails
- Doubles Liquor Storage
- Removable

*Not To Be Used With Any Other Manufacturers Speed Rails*

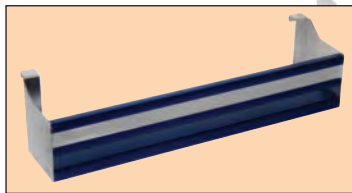

L	Model #	Price	Cap.	Approx. Wt.	Approx. Cu. Ft.
12"	PRHSR-12	\$203	3	4 lbs.	1
18"	PRHSR-18	218	4	4 lbs.	2
24"	PRHSR-24	233	6	5 lbs.	2
30"	PRHSR-30	247	7	6 lbs.	2
36"	PRHSR-36	266	9	6 lbs.	3
42"	PRHSR-42	279	10	7 lbs.	3
48"	PRHSR-48	299	12	7 lbs.	4

For Prestige Liquor Racks & Cabinets, See Page 109.

### BLENDER SHELVES

Mounts To The Front Apron Of Ice Bin

- All Stainless Steel Construction
- 10" Wide
- Grommet Hole For Blender Power Cords
- 15A - 120V Duplex Outlet Hidden Beneath Blender Shelf
- Keyhole Installation



15A - 120V Duplex Receptacle Hidden Beneath Blender Shelf



**EXCLUSIVELY**

For Prestige Underbar Equipment

PRA-BS-12	12" Shelf .....	\$249
PRA-BS-18	18" Shelf .....	267
PRA-BS-24	24" Shelf .....	305
PRA-BS-30	30" Shelf .....	315

For Free-Standing Blender Stations, See Page 111.

# FRIDGE & COOLERS

## Back Bar Refrigeration & Coolers

### GLASS FROSTERS

- Stainless Steel Sliding Lids
- 2 Adjustable Dividers & Shelving
- **GF24-B:** 100 8" Plates/76 Mugs
- **GF34-B:** 150 8" Plates/94 Mugs
- Foam Polyurethane Insulation
- Automatic Defrosting
- R404A Refrigerant
- Black Vinyl Coated Steel
- 6' NEMA5-15P Electrical Cord
- 7 Amps/115V/1 Phase
- 2 Year Parts/Labor 5 Year Compressor (Parts) Warranty



NEMA PLUG 5-15P



GF24-B

Model #	Price	Size	Wt.	Cu. Ft.
<b>GF24-B</b>	<b>\$7026</b>	24" x 26" x 33 5/8"	183 lbs.	13
<b>GF34-B</b>	<b>7109</b>	34" x 26" x 33 5/8"	227 lbs.	19
<b>GF48-B</b>	<b>9037</b>	48" x 26" x 33 5/8"	276 lbs.	26

### BOTTLE/CAN COOLERS

- Stainless Steel Construction w/ Black Vinyl Exterior
- Sliding Stainless Steel Lid(s)
- Built In Bottle Opener & Cap Catcher
- Adjustable Dividers
- Ventilated Cooling Fan System
- Uses R134A Refrigerant
- Efficient Forced-Air Refrigeration System To Maintain Temperatures Between 32° And 41° Fahrenheit
- Automatic Defrosting
- Foam Polyurethane Insulation
- 8' NEMA5-15P Electrical Cord
- Single Phase Wiring
- 2 Year Parts/Labor 5 Year Compressor (Parts) Warranty



NEMA PLUG 5-15P



BC-B-50

Black Finish	Price	O.A. Dimensions	# of 12 oz. Bottles/Cans	Dividers	Lids	Amps/Volts	HP	Wt.	Cu.
<b>BC-B-35</b>	<b>\$6007</b>	35" x 26 1/2" x 33 7/8"	9-1/3 Cases / 11-1/2 Cases	2	1	4.5/115v	1/5	214 lbs.	19
<b>BC-B-50</b>	<b>6707</b>	50" x 26 1/2" x 33 7/8"	17-1/2 Cases / 23-3/4 Cases	3	2	6.3/115v	1/3	378 lbs.	27
<b>BC-B-65</b>	<b>7530</b>	65" x 26 1/2" x 33 7/8"	25-1/4 Cases / 34-3/4 Cases	4	2	6.3/115v	1/3	388 lbs.	35

### BACK BAR REFRIGERATION



- Stainless Steel Top w/ Black Vinyl Coated Steel Sides
- Hinged Door(s) With Locks
- Adjustable Epoxy Shelves
- Interior Lighting with On/Off switch
- 8' NEMA5-15P Electrical Cord
- Single Phase Wiring
- Uses R134A Refrigerant
- 2 Year Parts/Labor 5 Year Compressor (Parts) Warranty



BBR-48



NEMA PLUG 5-15P

	Model #	Price	O.A. Dimensions	# of Kegs	Shelves	Doors	Amps/Volts	HP	Wt.	Cu.
<b>23 1/2" WIDE</b>	<b>BBR-36</b>	<b>\$8257</b>	36" x 23 1/2" x 36"	2	2	1	5.0/115v	1/5	250 lbs.	18
	<b>BBR-48</b>	<b>8524</b>	48" x 23 1/2" x 36"	2	4	2	5.0/115v	1/4	306 lbs.	26
	<b>BBR-72</b>	<b>9722</b>	72" x 23 1/2" x 36"	3	6	3	5.0/115v	1/4	366 lbs.	36
<b>28 3/16" WIDE</b>	<b>BBR-59</b>	<b>8856</b>	59" x 28 3/16" x 37 1/4"	2	4	2	7.2/115v	1/3	354 lbs.	37
	<b>BBR-79</b>	<b>11320</b>	79" x 28 3/16" x 37 1/4"	4	4	3	7.2/115v	1/3	439 lbs.	50
	<b>BBR-95</b>	<b>13171</b>	95" x 28 3/16" x 37 1/4"	5	6	3	7.2/115v	1/3	498 lbs.	60

**Stainless Steel Exterior Upgrade**  
**BBR-1**  
**\$749 /per unit**  
 For BBR Series, BC-B Series, GF Series Only

**Add Glass Doors**



**SU-100**  
**\$1177 /per unit**  
 For BBR Series

**Add Casters**



**BBR-25-3 3" Casters**  
**\$461/per unit**  
 For BBR Series, BC-B Series, GF Series Only

**BBR-25-6 6" Casters**  
**\$485/per unit**  
 For BBR Series

# UNDERBAR ACCESSORIES

## Underbar Modifications & Accessories

### More Underbar Accessories

<b>A-1</b>	Perforated Cover for 10" x 14" x 10" Sink Bowl	.....	<b>\$120</b>
<b>A-8</b>	24" Condiment Rack (5 Condiment Cups) <i>Condiment Racks Hang On Backsplash Of Ice Bin</i>	.....	<b>559</b>
<b>SU-17</b>	Interior Partition (For Underbar Basics & Prestige <i>Drainboard Cabinets - Factory Installed Only</i> )	.....	<b>210</b>
<b>K-12</b>	Replacement Deck Mounted Soap Dispenser	.....	<b>144</b>
<b>SU-55</b>	Removable Stainless Steel Divider For Beer Box	.....	<b>169</b>

### Underbar Modifications

<b>A-51</b>	6" Hole In Drainboard Surface <i>(Waste Chute Installation)</i>	.....	<b>146</b>
<b>PR-STRAP</b>	Stainless Steel Straps For Speed Rails <i>(Set of 2 - For KS-2K Speed Rail Only)</i>	.....	<b>43</b>
<b>SU-4</b>	Modify Prestige Series Backsplash to 4" Tall	.....	<b>24 Lin. Ft.</b>
<b>SU-10A</b>	Upgrade To S/S Legs & Bullet Feet <i>(18" Legs - Includes Adjustable Front-to-Back Cross-Bracing)</i>	.....	<b>243</b>
<b>SU-10B</b>	Upgrade To S/S Legs & Bullet Feet <i>(10" Legs - Includes Adjustable Front-to-Back Cross-Bracing)</i>	.....	<b>243</b>
<b>SU-10C</b>	Upgrade To S/S Legs & Bullet Feet <i>(14" Legs - Includes Adjustable Front-to-Back Cross-Bracing)</i>	.....	<b>243</b>
<b>SU-13</b>	Upgrade to 10-Circuit Cold Plate <i>(Applies to units with 7-Circuit Cold Plate)</i>	.....	<b>447</b>
<b>SU-18RorL</b>	Right or Left Welded Side Splash for 18" Wide Unit	.....	<b>161</b>
<b>SU-18RL</b>	Right & Left Welded Side Splash for 18" Wide Unit	.....	<b>325</b>
<b>SU-21RorL</b>	Right or Left Welded Side Splash for 21" Wide Unit	.....	<b>175</b>
<b>SU-21RL</b>	Right & Left Welded Side Splash for 21" Wide Unit	.....	<b>341</b>
<b>SU-22A</b>	Add 10"x14"x10" Sink To Drbd. Cabinet <i>(Includes Splash Mt. Faucet)</i>	.....	<b>924</b>
<b>SU-22C</b>	Add 9" x 9" x 4" Sink To Drbd. Cabinet <i>(Includes Splash Mt. Faucet)</i>	.....	<b>924</b>
<b>SU-24</b>	Provision To Connect Underbar Equipment <i>(Price Per Every Two Units)</i>	.....	<b>140</b>
<b>SU-30</b>	Soda Chase Provision - Tip-Out <i>(For Ice Bins w/ Backsplash Only)</i>	.....	<b>447</b>
<b>SU-33</b>	Working Height to Underbar Equipment	.....	<b>95</b>
<b>SU-34</b>	Top Cutout for Under Bar Equipment	.....	<b>95</b>
<b>SU-36</b>	Add 5-1/2" Diameter Waste Chute <i>(Blender Stations &amp; Drainboard Cabinets Only)</i>	.....	<b>833</b>
<b>SU-40</b>	Prep Unit For Installation Of Speed Rails	.....	<b>81</b>
<b>SU-41</b>	Make Speed Rail An Odd Length	.....	<b>68</b>
<b>SU-42</b>	Make Speed Rail Accommodate 1/2 Gallon Bottles	.....	<b>89</b>
<b>SU-61</b>	Special Sizing To Reduce Length	.....	<b>N/C</b>
<b>SU-61A</b>	Special Modification	.....	<b>249</b>
<b>SU-62C</b>	Recess GFI Outlet For Bar Die	.....	<b>480</b>
<b>SU-68</b>	Omit Corrugation On Drainboards <i>(Flat Top Work Surface)</i>	.....	<b>145</b>
<b>SU-79</b>	Additional Drainboard Length <i>(Flat Top Work Surface)</i>	.....	<b>136 Lin. Ft.</b>

### PERFORATED BASKETS FOR UNDERBAR SINKS



**A-16 \$239**  
Fits 10" x 14" x 10" Sink



**A-17 \$234**  
Fits 9 1/2" x 11 1/2" x 6" Sink



**A-23 \$224**  
Fits 6" x 11" x 6" Sink

**A-17A \$242**  
Fits 9" x 9" x 4" Sink

### REMOVABLE BLACK PLASTIC BOTTLE RACKS



**A-19 \$16 ea.**  
Single Bottle Rack  
5 1/4" x 5 1/4"



**A-20 \$46 ea.**  
3-Pack Bottle Rack  
(6 Per Carton. Must Order in Qties. of 6)  
5 1/4" x 15 7/8"



**A-18 \$42 ea.**  
4-Pack Bottle Rack  
5" x 16 1/2"

### STAINLESS STEEL FALSE BOTTOM



- A-41** For 24" Ice Bin..... **\$112**
- A-42** For 30" Ice Bin..... **122**
- A-43** For 36" Ice Bin..... **135**
- A-44** For 42" Ice Bin..... **146**
- A-45** For 48" Ice Bin..... **156**

### SLIDING STAINLESS STEEL COVER For Free-Standing Underbar Basics Ice Bins



- SSC-12** For 12" Ice Bin ..... **\$169**
- SSC-24** For 24" Ice Bin ..... **174**
- SSC-30** For 30" Ice Bin ..... **190**
- SSC-36** For 36" Ice Bin ..... **205**
- SSC-42** For 42" Ice Bin ..... **256**
- SSC-48** For 48" Ice Bin..... **263**
- SSC-PT** For Pass-Thru Ice Bin..... **335**

Replacement Sliding S/S Covers For Drop-in Ice Bins, See Page 84

### STAINLESS STEEL ICE BIN PARTITION



- A-38** 8" High..... **\$122**
- A-39** 12" High..... **122**
- A-40** 16" High..... **122**



**A-24 \$169**  
9" x 10.5" Add-On Blender Shelf  
w/ Duplex Outlet Hidden Beneath Shelf



**K-316-LU \$114**  
Add Wrist Handles  
For Deck Or Splash Mt. Faucets

# UNDERBAR ACCESSORIES

## Prestige Underbar Modifications & Accessories

### Prestige Ice Bin Accessories



<b>PRA-BR-3</b>	3-Bottle Well Support Frame For Ice Bin <i>(For 20" Wide Units &amp; Required For Use w/ Cover - Bottle Wells Not Included - Use A-20)</i>	.....	<b>\$108</b>
<b>PRA-2405</b>	24" Condiment Rack (5 Condiment Cups) <i>Condiment Racks Hang On Backsplash Of Ice Bin</i>	.....	<b>559</b>

### Prestige Bar Sink Accessories

<b>SU-20RorL</b>	Right or Left Side Splash for 20" Wide Unit	.....	<b>179</b>
<b>SU-20RL</b>	Right & Left Side Splash for 20" Wide Unit	.....	<b>375</b>
<b>SU-25RorL</b>	Right or Left Side Splash for 25" Wide Unit	.....	<b>213</b>
<b>SU-25RL</b>	Right & Left Side Splash for 25" Wide Unit	.....	<b>402</b>

### Prestige Underbar Modifications

<b>SU-4</b>	Modify Prestige Series Backsplash to 4" Tall	.....	<b>24</b>	Lin. Ft.
<b>SU-12A</b>	13" S/S "H" Leg Assembly <i>(Includes Adjustable Front-to-Back Cross-Bracing)</i>	.....	<b>243</b>	Pair
<b>SU-12B</b>	" S/S H" Leg Assembly For Extra Deep Ice Bins <i>(Includes Adjustable Front-to-Back Cross-Bracing)</i>	.....	<b>243</b>	Pair
<b>SU-27</b>	Cabinet Door Lock w/ Key	.....	<b>286</b>	
<b>SU-30</b>	Soda Chase Provision <i>(For Ice Bins w/ Backsplash Only)</i>	.....	<b>447</b>	
<b>SU-36</b>	Add Waste Chute <i>(Blender Stations Only)</i>	.....	<b>833</b>	
<b>SU-44</b>	Add S/S Glass Rack Slides <i>(Prestige Glass Rack Storage Cabinets Only)</i>	.....	<b>548</b>	2/Set
<b>SU-46</b>	Add S/S Full Extension Roller Slides <i>(Prestige Glass Rack Storage Cabinets Only)</i>	.....	<b>913</b>	
<b>SU-47</b>	Add S/S Concealing Drawer Front <i>(Prestige Glass Rack Storage Cabinets Only)</i>	.....	<b>457</b>	
<b>SU-62C</b>	Recess GFI Outlet For Bar Die <i>(Wiring by Others)</i>	.....	<b>480</b>	
<b>SU-73</b>	Add Mirror Finish <i>Factory Install Only</i>	.....	<b>408</b>	
<b>SU-74</b>	All Stainless Steel Construction Upgrade	.....	<b>486</b>	
<b>SU-75</b>	Add Welded Stainless Steel Cross-Bracing	.....	<b>117</b>	
<b>SU-77</b>	Modify Cabinet to be 25" Wide <i>(Prestige Drainboard Cabinets Only)</i>	.....	<b>83</b>	

## SODA GUN HOLDER

### Mounts In Prestige Underbar Line Up

- Provides Housing For WunderBar® Soda Gun (14 Button or Smaller)
- Built-In Soda Gun Holder with Drip Cup
- Cover Allows Easy Access To Make Adjustments
- Keeps Tubing Lines Hidden For A Cleaner Workspace
- Includes Backsplash



Model #	Price	Size* L x W x H	Approx. Weight	Approx. Cu. Ft.	PRSH-19-6 Shown
<b>SINGLE SODA GUN HOLDER (Holds One Gun On One Side)</b>					
<b>PRSH-19-6</b>	<b>\$610</b>	20" x 6" x 36"	19 lbs.	3	
<b>PRSH-24-6</b>	<b>696</b>	25" x 6" x 36"	20 lbs.	3	

For 4" Wide Soda Holder add **SU-61 N/C**

\*Height is from the finished floor to the top of the splash

NOTE: Drain Connection Is Required On Drip Cup

## PRESTIGE Signature Series



### TUBING CHASE

<b>PRA-19-TC</b>	For 20" Unit.....	<b>\$203</b>
<b>PRA-24-TC</b>	For 25" Unit.....	<b>211</b>

### STAINLESS STEEL TRASH RECEPTACLE COVER

*Trash Bin Not Included • Factory Install Only*



### PRSJ-12 \$698

- Open Unit
- Accommodates Slim Jim® Trash Can Measuring 11" x 20" x 25" (15 7/8 Gallon Capacity)\*
- Units Mount Between Equipment Line Up
- Overall Size: 12" x 25" x 21"
- 33 lbs. 4 Cu. Ft.

### SLIDING STAINLESS STEEL COVERS For Ice Bins



<b>PRA-SSC-12</b>	Fits 12" Ice Bin .....	<b>\$193</b>
<b>PRA-SSC-18</b>	Fits 18" Ice Bin .....	<b>196</b>
<b>PRA-SSC-24</b>	Fits 24" Ice Bin .....	<b>200</b>
<b>PRA-SSC-30</b>	Fits 30" Ice Bin .....	<b>218</b>
<b>PRA-SSC-36</b>	Fits 36" Ice Bin .....	<b>234</b>
<b>PRA-SSC-42</b>	Fits 42" Ice Bin .....	<b>294</b>
<b>PRA-SSC-48</b>	Fits 48" Ice Bin .....	<b>302</b>
<b>PRA-SSC-PT30</b>	Fits PR-44X30SP-10L or R ..... & PR-42X30-10L or R	<b>430</b>
<b>PRA-SSC-PT42</b>	Fits PRPT-2442, PRPT-2442-10, ..... PR-44X42SP-10L or R & PR-42X42-10L or R	<b>463</b>

## PRESTIGE UNDERBAR ADD-ONS

### Stainless Steel Underbar Fillers

**Multiple Angles Available • Optional Legs**

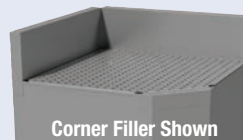

Corner Filler Shown

- Removable Perforated Drainboard Top
  - Bolt On To Sides Of Equipment
  - For Odd Shape Underbar Line Ups
- See Page 110

### Stainless Steel Base Cabinet

**Available With Or Without Doors**



- Provides Extra Storage In Bar Line Up
- Optional Door Lock

Contact Our SmartFab Department For Details & Pricing.  
SmartFab@advancetabco.com • 800-645-3166

# FAUCETS

## Underbar Equipment Faucets

All Items on This Page Ship via UPS

All Faucets Meet Federal Lead Free Standards

### UNDERBAR DECK MOUNTED SINK FAUCETS

6" Deck Mounted Faucet



**K-51 \$452**  
4" O.C.

3-1/2" Gooseneck



**K-52 \$221**  
4" O.C.

12" Swing Spout



**K-53 \$427**  
4" O.C.

Water Filler Faucet

**IMPROVED!**  
Stronger Actuator



**K-54**  
8-1/4" High **\$468**  
**K-54A**  
12" High **\$576**

Deck Mt. 6" Extended Spout 4" O.C.



**K-124 \$326**

**K-208 \$445**  
With Wrist Handles

Dipper Well Faucet



**A-33 \$153**

Gooseneck Deck Mount Melt Down Nozzle 4" O.C.

**A-29 \$499** **A-30 \$570** (Installed)



### UNDERBAR SPLASH MOUNTED SINK FAUCETS

3-1/2" Splash Mounted Faucet



**K-59 \$221**  
4" O.C.

Extra Heavy Duty Splash Mounted Faucet



**K-69 \$444**  
4" O.C.

Splash Mt. 6" Extended Spout 4" O.C.



**K-123 \$326**

Splash Mt. 6" Extended Spout with Wrist Handles



**K-206 \$425**  
4" O.C.

6" Splash Mounted Faucet



**K-125 \$295**  
4" O.C.

10" Splash Mounted Spout



**K-126 \$295**  
4" O.C.

Wrist Handles for Faucets



**K-316-LU \$114**

### UNDERBAR SINK ACCESSORIES

#### WASTE OUTLETS & CHUTES

1" Waste Outlet



**A-10**  
(6 per carton)  
**\$18**

1-1/2" Waste Outlet



**A-11**  
(6 per carton)  
**\$19**

5-1/2" Stainless Steel Open Waste Chute



**A-6 \$309**  
Factory Installed

5-1/2" Dipper Well with Insert and Drain



**A-7 \$384**  
Factory Installed (Includes  
TA-34 Table Top 6" Cut-Out)  
1-1/2" NPT Drain Connection

#### STAINLESS STEEL OVERFLOW PIPES



**1" Pipe**  
(6 per carton)

**A-12 \$18 ea.**



**1-1/2" Pipe**  
(6 per carton)

**A-13 \$19 ea.**

(Price per each, sold in a carton of 6.  
Broken carton price \$25.00 list per each)

#### SOAP DISPENSERS & HOLDERS

Deck Mounted Soap Dispenser

**K-12 \$144**



Chrome Towel Ring  
(Packed Loose)

**A-15 \$96**





# PORTABLE BARS

## Heavy Duty Portable Bars

**ALL STAINLESS STEEL INTERIOR!** Designed For Heavy-Duty, High Volume Operation!

### HEAVY DUTY OPEN BASE

- All Stainless Steel Bartender Side
- 19" x 13-1/2" x 11" Stainless Steel Integral Insulated Ice Bin
- Full Perimeter Bumpers
- 5" Heavy Duty Swivel Plate Casters (2 w/ Brakes)

- Drain & Shut-Off Valve
- Stainless Steel Speed Rails
- Open Bottom Shelf For Glass Rack Storage



Bar Top, Front, & Sides Material	Model	Price	Length	Width	Bar Top Width	# Of Speed Rails	Speed rail Capacity	Wt.	Cu. Ft.
Black Mica	AMS-5B	\$5857	62 1/4"	27 1/4"	12"	2	10 Btls.	315 lbs.	70
Black Mica	AMS-6B	6508	74 3/8"	27 1/4"	12"	3	15 Btls.	399 lbs.	73

### HEAVY DUTY WITH DOORS

- All Stainless Steel Bartender Side
- 19" x 13-1/2" x 11" Stainless Steel Integral Insulated Ice Bin
- Full Perimeter Bumpers
- 5" Heavy Duty Swivel Plate Casters (2 w/ Brakes)
- Drain & Shut-Off Valve

- Stainless Steel Speed Rails
- Bottom Shelf For Glass Rack Storage
- Center Stainless Steel Panel For Extra Support
- Hinged Door With Lock On Left & Right Side Of Center Support Panel

Bar Top, Front, & Sides Material	Model	Price	Length	Width	Bar Top Width	# Of Speed Rails	Speed rail Capacity	Wt.	Cu. Ft.
Black Mica	AMD-5B	\$6531	62 1/4"	28 1/8"	12"	2	10 Btls.	340 lbs.	71
Black Mica	AMD-6B	7183	74 3/8"	28 1/8"	12"	3	15 Btls.	399 lbs.	73



**Upgrade with Cold Plates - Add suffix -7 after model # and add \$1712 to Bars cost. See Page 120 For All Portable Bar Modifications & Accessories.**



## Laminates & Stainless Steel Panels for Portable Series Bars

Add model number at end of Portable bar model number when ordering & add additional cost.  
(Example: AMD-6B-LCW)



**-LMP Add \$1830**  
Marula Pine  
Exterior front & sides only



**-LCW Add \$1830**  
Columbian Walnut  
Exterior front & sides only



**-LCM Add \$1830**  
Calcutta Marble  
Exterior front & sides only



**-SS Add \$3200**  
All Stainless Steel  
Including Top



### Need a Custom Color?



Custom Colors Available  
**SU-81**  
Consult Factory For Pricing & Details

See Page 120 For Even More Options

# PORTABLE BARS

## Portable Bars



**Designed For Heavy-Duty Use.  
Perfect for High Volume Operation!**

### STANDARD BLACK MICA BAR

- All Black Mica Finish
- Stainless Steel Countertop
- 18" x 20" x 10" Stainless Steel Integral Insulated Ice Bin
- Drain & Shut-Off Valve
- Open Bottom Shelf For Glass Rack Storage
- Towel Ring
- Dual Plastic Speed Rails (10 Bottle Capacity)
- 4" Swivel Plate Casters (2 w/ Brakes)

Top, Front, Back & Sides Material	Model	Price	Length	Width	Bar Top Width	Wt.	Cu. Ft.
Black Mica	D-B	\$4628	61"	24.50"	11"	310 lbs.	60



D-B Bartender Side Shown

### BAR WITH ALL STAINLESS STEEL WORK AREA

- Stainless Steel Countertop, Backsplash & Inside Side Panels
- 19" x 13-1/2" x 11" Stainless Steel Integral Insulated Ice Bin
- Dual Plastic Speed Rails (10 Bottle Capacity)
- Open Bottom Shelf & Mid Shelf For Glass Rack Storage
- 5" Heavy Duty Swivel Plate Casters (2 w/ Brakes)
- 2 Towel Rings

Top, Front, Back & Sides Material	Model	Price	Length	Width	Bar Top Width	Wt.	Cu. Ft.
Black Mica	R-8-B	\$9842	95.75"	24.50"	12"	550 lbs.	117



R-8-B Bartender Side Shown

### Portable Bar Modifications & Accessories



BK-2

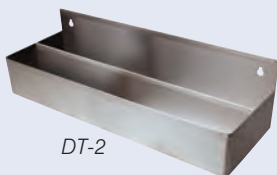

DT-2



SU-80



-7

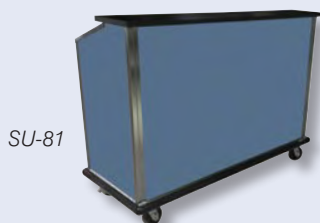

SU-81

**-7** 7-Circuit Cold Plate Sealed Into Bottom ..... **\$1712**  
Of Ice Bin Add The Suffix -7 To The Model  
Number & Add To Cost (Factory Installed Only)

**BK-2** Stainless Steel Speed Rail ..... **106**

**DT-2** Double Tier Stainless Steel ..... **191**  
Speed Rail

**SU-80** Continuous Bumper on 3 Sides..... **940**

**SU-81** Custom Mica Colors Or S/S Panels ..... **Call Factory**  
Custom Colors Include Exterior Finishes Only  
(Bar Front And Sides. Additional Charge For  
Bar Top. All Interiors Are Standard Black Finish,  
Excluding AMS & AMD Series)

**See Page 119 For Optional Laminates & Stainless Steel Options**

# ADVANCE TABCO HOT & COLD FOOD TABLES & DROP-INS



## Features:

- Stainless Steel Body, Top & Sides
- Fiberglass Insulation (Excludes Solid Top Tables)
- 1" I.P.S. Drain (Excludes Solid Top Tables)
- Galvanized Legs with Adjustable Bullet Feet

**Refrigerated & Hot Well Drop-Ins**



**Electric & Gas Hot Food Tables**



**Solid Top Tables**



**Everyday Buffet Tables**



**Ice-Cooled Tables**



**Refrigerated Tables**



### Sealed Wells

These units allow water to be poured directly into the unit and get heated. Food bins may be used without the use of a Spillage Pan.



### Standard Wells

Never pour water directly into these type of units. To use hot water in these units, must use with **Model# SP-A Aluminum Spillage Pans** or **Model # SP-S S/S Spillage Pans**.



### Refrigerated

These units are designed to maintain chilled foods at the proper temperature.

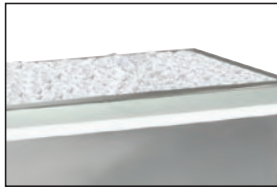

### Non-Refrigerated

Units are designed to cool foods already chilled using only ice within its insulated bin. There is no refrigeration unit in this equipment.



# HOT WELL DROP-INS

## Electric Sealed Well Hot Food Drop-In Units

- 304 Stainless Steel Top
- Fiberglass Insulation Between Compartments
- 12" X 20" Die Stamped Pan Openings
- 6" Deep Units

- 1" I.p.s. Drain
- Remote Control Panel
- Infinite Control Knobs
- Indicator Lights

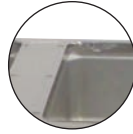

Individual Sealed Well Compartments



DISW-3-120 Shown

### STANDARD DROP-IN UNITS

Model #	Price	Length	Width	# of Wells	Cut-Out Size W x L	Volts	Amps	Watts	Approx. Wt.	Cu. Ft.
DISW-1-120	\$2101	15-1/2"	24-1/2"	1	23-1/2" x 15-5/8"	120	9.17	1100	73 lbs.	6
DISW-2-120	3039	30-1/2"	24-1/2"	2	23-1/2" x 29-5/8"	120	12.34	2200	110 lbs.	6
DISW-3-120	3689	44-1/2"	24-1/2"	3	23-1/2" x 43-5/8"	120	27.51	3300	135 lbs.	6
DISW-1-240	2101	15-1/2"	24-1/2"	1	23-1/2" x 15-5/8"	208/240	3.97/4.58	825/1100	73 lbs.	6
DISW-2-240	3039	30-1/2"	24-1/2"	2	23-1/2" x 29-5/8"	208/240	7.94/9.16	1650/2200	110 lbs.	6
DISW-3-240	3689	44-1/2"	24-1/2"	3	23-1/2" x 43-5/8"	208/240	11.91/13.74	2475/3300	135 lbs.	18
DISW-4-240	4382	58-1/2"	24-1/2"	4	23-1/2" x 57-5/8"	208/240	15.88/18.32	3300/4400	180 lbs.	23
DISW-5-240	5706	72-1/2"	24-1/2"	5	23-1/2" x 71-5/8"	208/240	19.85/22.90	4125/5500	208 lbs.	35
DISW-6-240*	6729	86-1/2"	24-1/2"	6	23-1/2" x 85-5/8"	208/240	23.82/27.48	4950/6600	275 lbs.	35

\*6-well unit include two sets of control panels

**NOTE:** Units are not designed to cook or heat frozen or refrigerated foods. Food placed in tables should already be hot, and the table will maintain the proper temperatures



DISLSW-2-120 Shown

### SLIMLINE DROP-IN UNITS

Model #	Price	Length	Width	# of Wells	Cut-Out Size W x L	Volts	Amps	Watts	Approx. Wt.	Cu. Ft.
DISLSW-2-120	\$3361	46-1/2"	16-1/2"	2	15-1/4" x 45-1/4"	120	18.34	2200	95 lbs.	11
DISLSW-3-120	4033	68-1/2"	16-1/2"	3	15-1/4" x 67-1/4"	120	27.51	3300	125 lbs.	11
DISLSW-2-240	3361	46-1/2"	16-1/2"	2	15-1/4" x 45-1/4"	208/240	3.94/9.16	1600/2200	95 lbs.	18
DISLSW-3-240	4033	68-1/2"	16-1/2"	3	15-1/4" x 67-1/4"	208/240	11.90/13.34	2475/3300	150 lbs.	18
DISLSW-4-240	5663	90-1/2"	16-1/2"	4	15-1/4" x 89-1/4"	208/240	15.88/18.32	3300/4400	155 lbs.	23

### Drop-In Unit Options & Accessories

OPTIONAL NEMA 6' CORD WITH PLUGS AVAILABLE:

Drop-In Units to be hard wired in the field. Please consult the factory for more information.



NEMA 5-15P  
SU-P-234

1 well, 120v Units



NEMA L5-30P  
SU-P-232

1, 2, 3 or 6 well, 240v Units  
(6 well unit requires 2 Cords)



NEMA 6-20P  
SU-P-231

2 or 3 well, 120v Units

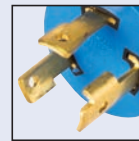

NEMA L6-30P  
SU-P-233

4 or 5 well, 240v Units

#### Autofill Upgrade

Automatically fills & maintains water level. For DISW, DISLSW, SW & HDSW Series. Requires added cost Manifold Drain Assembly (Except HDSW series). See below.

SU-90 \$1980 Autofill Only



#### Manifold Drain Assembly

Add The Suffix -M To The Model Number And Add Additional Pricing Below.

\$242 Per Well

#### Filler Faucet

- Hot Water Supply Only
- Requires -M Manifold Drain Assembly
- Faucet Location To Be Specified When Ordering

K-49 \$371



#### Thermostatic Controls

Add The Suffix -T To The Model Number And Add Additional Pricing Below.

\$213 Per Well

# HOT FOOD TABLES

## Electric Hot Food Tables



- Stainless Steel Body & Top
- Galvanized Legs, Undershelf & Adjustable Bullet Feet
- Enclosed Base Units Include Stainless Steel Body & Shelf
- Fiberglass Insulation Between Each Compartment
- 8" Wide Poly Cutting Board Shelf - Ships K.D.

- Galvanized Liner. (Optional Stainless Steel Liner upgrade available **Model # SU-32 \$121 per well**)
- Infinite Control Knobs & Indicator Lights
- Single Phase Wiring (Upgrade to 3 Phase Wiring for 240 Volt Units- **Model # SU-72 \$470**)



w/ Undershelf  
HF-2E-240 Shown

### Undershelf

Model #	Price	Length	Width*	# of Wells	Volts	Amps	Watts	NEMA Plug	Wt.	Cu. Ft.
HF-2E-120	\$2093	31-13/16"	30-5/8"	2	120	8.33	1000	5-20P	92 lbs.	28
HF-3E-120	2255	47-1/8"	30-5/8"	3	120	12.50	1500	5-20P	130 lbs.	41
HF-4E-120	3052	62-7/16"	30-5/8"	4	120	16.67	2000	L5-30P	152 lbs.	55
HF-2E-240	2093	31-13/16"	30-5/8"	2	208/240	7.21/8.33	1500/2000	6-20P	92 lbs.	28
HF-3E-240	2255	47-1/8"	30-5/8"	3	208/240	10.82/12.50	2250/3000	6-20P	120 lbs.	41
HF-4E-240	3052	62-7/16"	30-5/8"	4	208/240	14.42/16.67	3000/4000	L6-30P	152 lbs.	55
HF-5E-240	4035	77-3/4"	30-5/8"	5	208/240	18.03/20.84	3750/5000	L6-30P	170 lbs.	67

\*Width Includes 8" Cutting Board

See Below For Stainless Steel Legs & Undershelf Upgrade

### Enclosed Base

Model #	Price	Length	Width*	# of Wells	Volts	Amps	Watts	NEMA Plug	Wt.	Cu. Ft.
HF-2E-120-BS	\$4053	31-13/16"	30-5/8"	2	120	8.33	1000	5-20P	92 lbs.	28
HF-3E-120-BS	4467	47-1/8"	30-5/8"	3	120	12.50	1500	5-20P	210 lbs.	41
HF-4E-120-BS	5426	62-7/16"	30-5/8"	4	120	16.67	2000	L5-30P	250 lbs.	55
HF-2E-240-BS	4053	31-13/16"	30-5/8"	2	208/240	7.21/8.33	1500/2000	6-20P	92 lbs.	28
HF-3E-240-BS	4467	47-1/8"	30-5/8"	3	208/240	10.82/12.50	2250/3000	6-20P	210 lbs.	41
HF-4E-240-BS	5426	62-7/16"	30-5/8"	4	208/240	14.42/16.67	3000/4000	L6-30P	250 lbs.	55
HF-5E-240-BS	6470	77-3/4"	30-5/8"	5	208/240	18.03/20.84	3750/5000	L6-30P	290 lbs.	67

\*Width Includes 8" Cutting Board



Enclosed Base  
HF-5E-240-BS Shown with  
Optional TA-255P Casters

### Enclosed Base w/ Sliding Doors

Model #	Price	Length	Width*	# of Wells	Volts	Amps	Watts	NEMA Plug	Wt.	Cu. Ft.
HF-2E-120-DR	\$4671	31-13/16"	30-5/8"	2	120	8.33	1000	5-20P	127 lbs.	28
HF-3E-120-DR	5233	47-1/8"	30-5/8"	3	120	12.50	1500	5-20P	155 lbs.	41
HF-4E-120-DR	6186	62-7/16"	30-5/8"	4	120	16.67	2000	L5-30P	197 lbs.	55
HF-2E-240-DR	4671	31-13/16"	30-5/8"	2	208/240	7.21/8.33	1500/2000	6-20P	127 lbs.	28
HF-3E-240-DR	5233	47-1/8"	30-5/8"	3	208/240	10.82/12.50	2250/3000	6-20P	155 lbs.	41
HF-4E-240-DR	6186	62-7/16"	30-5/8"	4	208/240	14.42/16.67	3000/4000	L6-30P	197 lbs.	55
HF-5E-240-DR	7195	77-3/4"	30-5/8"	5	208/240	18.03/20.84	3750/5000	L6-30P	215 lbs.	67

\*Width Includes 8" Cutting Board



w/ Sliding Doors  
HF-5E-240-DR Shown

NOTE: Units are not designed to cook or heat frozen or refrigerated foods. Food placed in tables should already be hot, and the table will maintain the proper temperatures

## Food Table Modifications & Accessories

For Our Full Line Of Hot Food Table Modifications, Accessories & Replacement Parts, See Page 134-138

**Stainless Steel Legs & Undershelf Upgrade \$692**

2 Wells	3 Wells	4 Wells	5 Wells
SU-23A	SU-23B	SU-23C	SU-23D



**Galvanized Undershelf For Food Tables**

2 Wells	3 Wells	4 Wells	5 Wells
SU-30-UG2 \$254	SU-30-UG3 \$323	SU-30-UG4 \$415	SU-UG5 \$468



**SU-255** Add Casters to Food Units w/Undershelf **\$394 Set of 4**  
(Includes 4 - 5" Swivel Casters, 2 w/ Brakes & Legs that maintain height)

**TA-255P** Add Casters to Enclosed Base Food Units (Includes 4 - 5" Bolted Swivel Casters, 2 w/ Brakes) **636 Set of 4**

**SU-5G** Replacement Galvanized legs with Bullet Foot For Hot/Ice Cooled Table with Undershelf **69 ea.**  
(HF, SW, WB, STU or CPU Series)

**TCB-OMIT** Remove Poly Cutting Board & Shelf **-200 ea.**

**CB-OMIT** Remove Poly Cutting Board Only **-100 ea.**

**SU-19** Prepare Hot Tables To Be Locked Together (One Charge For Each Table To Be Interlocked) **\$539 ea.**

**SU-32** Upgrade to a Stainless Steel Lining (For Electric Units. Excludes Sealed Hot Well Units) **121 per well**

**SP-A** Aluminum Spillage Pan **125 ea.**

**SP-S** Stainless Steel Spillage Pan **219 ea.**

**SU-72** Upgrade 240 volt units to 3-Phase Wiring **470 ea.**

# HOT FOOD TABLES

## Electric Sealed Well Hot Food Tables



- Stainless Steel Body & Top
- Galvanized Legs, Undershelf & Adjustable Bullet Feet
- Enclosed Base Units Include Stainless Steel Body & Shelf
- Stainless Steel Lining
- Fiberglass Insulation Between Each Compartment
- Drains With Gate Valves Per Well

- 8" Wide Poly Cutting Board Shelf - Ships K.D.
- 6 Ft. Electric Cord w/ Plug Included
- Infinite Control Knobs & Indicator Lights
- Single Phase Wiring (Upgrade to 3 Phase Wiring for 240 Volt Units- **Model # SU-72 \$470**)

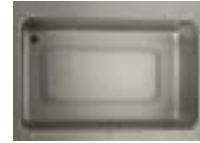

Sealed Well with Drain Shown

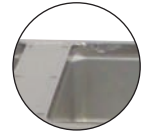

Individual Sealed Well Compartments

### Undershelf

Model #	Price	Length	Width*	# of Wells	Volts	Amps	Watts	NEMA Plug	Wt.	Cu. Ft.
SW-2E-120	\$2520	31-13/16"	30-5/8"	2	120	10.67	1280	5-20P	92 lbs.	28
SW-3E-120	3025	47-1/8"	30-5/8"	3	120	16	1920	5-20P	135 lbs.	55
SW-4E-120	4266	62-7/16"	30-5/8"	4	120	21.33	2560	L5-30P	230 lbs.	55
SW-2E-240	2520	31-13/16"	30-5/8"	2	208/240	7.94/9.16	1650/2200	6-20P	92 lbs.	28
SW-3E-240	3025	47-1/8"	30-5/8"	3	208/240	11.91/13.74	2475/3300	6-20P	135 lbs.	41
SW-4E-240	4266	62-7/16"	30-5/8"	4	208/240	15.88/18.32	3300/4400	L6-30P	230 lbs.	55
SW-5E-240	5299	77-3/4"	30-5/8"	5	208/240	19.85/22.90	4125/5500	L6-30P	220 lbs.	67

\*Width Includes 8" Cutting Board

See Below For Stainless Steel Legs & Undershelf Upgrade



w/ Undershelf  
SW-3E-120 Shown

### Enclosed Base

Model #	Price	Length	Width*	# of Wells	Volts	Amps	Watts	NEMA Plug	Wt.	Cu. Ft.
SW-2E-120-BS	\$4719	31-13/16"	30-5/8"	2	120	10.67	1280	5-20P	127 lbs.	28
SW-3E-120-BS	5420	47-1/8"	30-5/8"	3	120	16	1920	5-20P	155 lbs.	41
SW-4E-120-BS	6662	62-7/16"	30-5/8"	4	120	21.33	2560	L5-30P	197 lbs.	54
SW-2E-240-BS	4719	31-13/16"	30-5/8"	2	208/240	7.94/9.16	1650/2200	6-20P	127 lbs.	28
SW-3E-240-BS	5420	47-1/8"	30-5/8"	3	208/240	11.91/13.74	2475/3300	6-20P	155 lbs.	41
SW-4E-240-BS	6662	62-7/16"	30-5/8"	4	208/240	15.88/18.32	3300/4400	L6-30P	197 lbs.	55
SW-5E-240-BS	7853	77-3/4"	30-5/8"	5	208/240	19.85/22.90	4125/5500	L6-30P	215 lbs.	67

\*Width Includes 8" Cutting Board



Enclosed Base  
SW-5E-240-BS Shown  
with Optional TA-255P Casters

### Enclosed Base w/ Sliding Doors

Model #	Price	Length	Width*	# of Wells	Volts	True Amps/ Watts Per Unit	NEMA Plug	Wt.	Cu. Ft.
SW-2E-120-DR	\$5237	31-13/16"	30-5/8"	2	120	10.67/1280	5-20P	157 lbs.	28
SW-3E-120-DR	6407	47-1/8"	30-5/8"	3	120	16/1920	5-20P	145 lbs.	41
SW-4E-120-DR	7871	62-7/16"	30-5/8"	4	120	21.33/2560	L5-30P	187 lbs.	54
SW-2E-240-DR	5237	31-13/16"	30-5/8"	2	208/240	9.17/2200	6-20P	157 lbs.	28
SW-3E-240-DR	6407	47-1/8"	30-5/8"	3	208/240	13.75/3300	6-20P	145 lbs.	41
SW-4E-240-DR	7871	62-7/16"	30-5/8"	4	208/240	18.33/4400	L6-30P	260 lbs.	54
SW-5E-240-DR	8508	77-3/4"	30-5/8"	5	208/240	22.92/5500	L6-30P	281 lbs.	67

\*Width Includes 8" Cutting Board



w/ Sliding Doors  
SW-5E-240-DR Shown

NOTE: Units are not designed to cook or heat frozen or refrigerated foods. Food placed in tables should already be hot, and the table will maintain the proper temperatures

## Food Table Accessories & Modifications

For Our Full Line Of Hot Food Table Modifications, Accessories & Replacement Parts, See Page 134-138

Stainless Steel Legs & Undershelf Upgrade \$692			
2 Wells	3 Wells	4 Wells	5 Wells
SU-23A	SU-23B	SU-23C	SU-23D

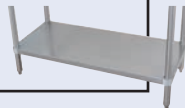

Galvanized Undershelf For Food Tables			
2 Wells	3 Wells	4 Wells	5 Wells
SU-30-UG2 \$254	SU-30-UG3 \$323	SU-30-UG4 \$415	SU-UG5 \$468

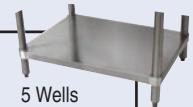

-T	Thermostatic Control (Per Well)	\$213 ea.
-M	Manifold Drains (Per Well)	242 ea.
SP-A	Aluminum Spillage Pan	125 ea.
SP-S	Stainless Steel Spillage Pan	219 ea.
SU-255	Add Casters to Food Units w/Undershelf (Includes 4 - 5" Swivel Casters, 2 w/ Brakes & Legs that maintain height)	394 Set of 4
TA-255P	Add Casters to Enclosed Base Food Units (Includes 4 -5" Bolted Swivel Casters, 2 w/ Brakes)	636 Set of 4
SU-5G	Replacement Galvanized Legs with Bullet Foot For Hot/Ice Cooled Table with Undershelf (HF, SW, WB, STU or CPU Series)	69 ea.

SU-32G	Upgrade to a Stainless Steel Lining (For Gas Units. Excludes Wetbath Units)	\$121 per well
SU-90	Automatically fills & maintains water level. For DISW, DISLSW, SW & HDSW Series. Requires added cost Manifold Drain Assembly (Except HDSW series). See page 122.	\$1980 Autofill Only
K-49	Filler Faucet for Hot Tables (Hot water supply only. Requires -M Manifold Drain & SU-15 Prepare for Filler Faucet Provision)	371 ea.
SU-15	Prepare Hot food Table For Filler Faucet (For Gas Units. Excludes Wetbath Units)	726 ea.
TCB-OMIT	Remove Poly Cutting Board & Shelf	-200 ea.
CB-OMIT	Remove Poly Cutting Board Only	-100 ea.



# HOT FOOD TABLES

## Gas Powered Hot Food Tables

### For Use with Optional Spillage Pans

- These Units Are Designed For Dry Operation Only.
- Stainless Steel Body & Top
- Galvanized Legs, Undershelf & Adjustable Bullet Feet
- Enclosed Base Units Include Stainless Steel Body & Shelf
- Galvanized Liner. (Optional Stainless Steel Liner upgrade available **Model # SU-32G \$121 per well**)
- 3500 BTU'S Per burner
- Fiberglass Insulation Between Each Compartment
- 8" Wide Poly Cutting Board Shelf - Ships K.D.
- Pilot Indicator Openings
- 1/2" Female NPT Connection To Regulator
- Infinite Control Knobs

Available For Natural Gas (NAT) Or Bottled Gas (LP)

### Undershelf



w/ Undershelf  
HF-3G-NAT Shown

Model #	Price	Length	Width*	# of Wells	Approx. Weight	Approx. Cu. Ft.
HF-2G-NAT or LP	\$2163	31-13/16"	30-5/8"	2	92 lbs.	28
HF-3G-NAT or LP	2408	47-1/8"	30-5/8"	3	130 lbs.	41
HF-4G-NAT or LP	2924	62-7/16"	30-5/8"	4	165 lbs.	55
HF-5G-NAT or LP	3600	77-3/4"	30-5/8"	5	170 lbs.	67

\*Width Includes 8" Cutting Board

For Stainless Steel Legs & Undershelf Upgrade See Page 118

### Enclosed Base



Enclosed Base  
HF-5G-LP-BS Shown  
with Optional TA-255P Casters

Model #	Price	Length	Width*	# of Wells	Approx. Weight	Approx. Cu. Ft.
HF-2G-NAT or LP-BS	\$3752	31-13/16"	30-5/8"	2	117 lbs.	28
HF-3G-NAT or LP-BS	4335	47-1/8"	30-5/8"	3	145 lbs.	41
HF-4G-NAT or LP-BS	5314	62-7/16"	30-5/8"	4	205 lbs.	55
HF-5G-NAT or LP-BS	6084	77-3/4"	30-5/8"	5	250 lbs.	67

\*Width Includes 8" Cutting Board

**SU-19** Prepare Hot Tables to be Locked Together **\$539 ea.**  
(One Charge For Each Table To Be Interlocked)

**NOTE:** External pressure regulator is required. 4" WC pressure in for Natural Gas and 10" WC pressure in for LP.

**NOTE:** Units are not designed to cook or heat frozen or refrigerated foods. Food placed in tables should already be hot, and the table will maintain the proper temperatures

## Sleek Shields™

### GLASS FOOD SHIELDS

Mounts To Top Of Hot/Cold Food Table

#### Self-Serve Style

- 18" Standard Height (Top of Table To Top)
- 1" Stainless Steel Tubing Posts (1 5/8" Posts Also Available)
- Includes Two 18" W x 15 3/8" H Glass Side Panels
- 1/4" Thick Heat-Tempered Glass Front & Sides
- Shipped KD



**Includes TA-47 Mounting Brackets**  
For In-Field Installation



**Chamber Lock™**  
Allows Front Glass To Lock In Place At 15° Intervals



NSG-15-4WELL Shown

15" Wide Stainless Steel Shelf			15" Wide w/ Glass Top			Fits # of Bowls	Approx. Wt.	Approx. Cubes
Model #	Price	O.A. Size L x W x H	Model #	Price	O.A. Size L x W x H			
NSG-15-2WELL	\$3291	33 9/16" x 19 3/4" x 18 1/2"	GSG-15-2WELL	\$3949	34 9/16" x 19 3/4" x 18"	Fits 2-Well Unit	109 lbs.	15
NSG-15-3WELL	3426	47 7/8" x 19 3/4" x 18 1/2"	GSG-15-3WELL	4097	49 7/8" x 19 3/4" x 18"	Fits 3-Well Unit	143 lbs.	22
NSG-15-4WELL*	4010	64 3/16" x 19 3/4" x 18 1/2"	GSG-15-4WELL*	4359	65 3/16" x 19 3/4" x 18"	Fits 4-Well Unit	189 lbs.	29
NSG-15-5WELL**	4380	78 1/2" x 19 3/4" x 18 1/2"		Not Available	Not Available	Fits 5-Well Unit	215 lbs.	38

GSG Series Food Shields are slightly longer than the table they rest on. They will extend about 7/8" on either end  
\*3/8" Thick Heat-Tempered Glass Required For Front Glass \*\*Requires a Single Center Post (Factory Print Included)

For Full Line Of Glass Top Food Shields & Food Table Accessories, See Page 135-137.

# HOT FOOD TABLES

## Gas Powered Wetbath Tables



- Stainless Steel Body & Top
- Galvanized Legs, Undershef & Adjustable Bullet Feet
- Enclosed Base Units Include Stainless Steel Body & Shelf
- Stainless Steel Liner
- Stainless Steel Dish Shelf
- 8" Wide Poly Cutting Board Shelf - Ships K.D.

- 1/2" Female NPT Connection To Regulator
- Pilot Indicator Openings
- Infinite Control Knobs
- **2 & 3 Comp:** 15,000 BTU's
- **4 & 5 Comp:** 25,000 BTU's

### Filler Faucet K-49 \$371



- Hot Water Supply Only
- Requires **-M** Manifold Drain Assembly & **SU-15** Filler Faucet Provision
- Faucet Location To Be Specified When Ordering

Available For Natural Gas (NAT) Or Bottled Gas (LP)

### Undershef

Model #	Price	Length	Width*	# of Wells	Approx. Weight	Approx. Cu. Ft.
WB-2G-NAT or LP	\$2703	31-13/16"	30-5/8"	2	96 lbs.	28
WB-3G-NAT or LP	2956	47-1/8"	30-5/8"	3	130 lbs.	41
WB-4G-NAT or LP	3415	62-7/16"	30-5/8"	4	157 lbs.	55
WB-5G-NAT or LP	4016	77-3/4"	30-5/8"	5	176 lbs.	67



See Below For Stainless Steel Legs & Undershef Upgrade

### Enclosed Base

Model #	Price	Length	Width*	# of Wells	Approx. Weight	Approx. Cu. Ft.
WB-2G-NAT or LP-BS	\$4314	31-13/16"	30-5/8"	2	145 lbs.	28
WB-3G-NAT or LP-BS	4633	47-1/8"	30-5/8"	3	175 lbs.	41
WB-4G-NAT or LP-BS	5178	62-7/16"	30-5/8"	4	225 lbs.	55
WB-5G-NAT or LP-BS	5792	77-3/4"	30-5/8"	5	296 lbs.	67



\*Width Includes 8" Cutting Board

NOTE: External pressure regulator is required. 4" WC pressure in for Natural Gas and 10" WC pressure in for LP.

NOTE: Units are not designed to cook or heat frozen or refrigerated foods. Food placed in tables should already be hot, and the table will maintain the proper temperatures

### Food Table Modifications & Accessories

For Our Full Line Of Hot Food Table Modifications, Accessories & Replacement Parts, See Page 131-134

Galvanized Undershef For Food Tables			
2 Wells	3 Wells	4 Wells	5 Wells
SU-30-UG2 \$254	SU-30-UG3 \$323	SU-30-UG4 \$415	SU-UG5 \$468



### 10" Wide Serving Shelf with Built-In Food Shield

Model	Price	Length	Approx. Wt.	Cu. Ft.
TSS-2	\$1025	31-13/16"	15 lbs.	3
TSS-3	1166	47-1/8"	17 lbs.	4
TSS-4	1272	62-7/16"	19 lbs.	5
TSS-5	1367	77-3/4"	21 lbs.	6

**SU-15** Prepare Hot Food Table for Filler Faucet (Faucet Not Included. Stationary Models Only) **\$726 ea.**

**SU-19** Prepare Hot Tables To Be Locked Together **539 ea.**  
(One Charge For Each Table To Be Interlocked)

**SU-25S** Add Casters to Food Units w/Undershef **394 Set of 4**  
(Includes 4 -5" Swivel Casters, 2 w/ Brakes)

**TA-255P** Add Casters to Enclosed Base Food Units (Includes 4 -5" Bolted Swivel Casters, 2 w/ Brakes) **636 Set of 4**

**SU-5G** Replacement Galvanized Legs with Bullet Foot For Hot/Ice Cooled Table with Undershef **69 ea.**  
(HF, SW, WB, STU or CPU Series)

**SP-A** Aluminum Spillage Pan **125 ea.**

**SP-S** Stainless Steel Spillage Pan **219 ea.**

**TCB-OMIT** Remove Poly Cutting Board & Shelf **-200 ea.**

**CB-OMIT** Remove Poly Cutting Board Only **-100 ea.**



### Acrylic Side Panel for Serving Shelf

Add side panels to meet additional NSF requirements (1 panel per side)

**TSP-1 \$259 One End**

**TSP-2 \$518 Two Ends**

Field Installation Available



# SOLID FOOD TABLES

## Solid Top Tables

- Stainless Steel Body & Top
- Galvanized Legs, Undershaft & Adjustable Bullet Feet
- Enclosed Base Units Include Stainless Steel Body & Shelf
- 8" Wide Poly Cutting Board Shelf - Ships K.D.



w/Undershaft  
STU-3 Shown

### Undershaft

Model #	Price	Length	Width*	Wt.	Cu. Ft.
STU-2	\$1352	31-13/16"	30-5/8"	90 lbs.	12
STU-3	1573	47-1/8"	30-5/8"	118 lbs.	17
STU-4	1866	62-7/16"	30-5/8"	150 lbs.	23
STU-5	2350	77-3/4"	30-5/8"	168 lbs.	41

\*Width Includes 8" Cutting Board

For Stainless Steel Legs & Undershaft Upgrade See Page 120



Enclosed Base  
STU-3-BS Shown

### Enclosed Base

Model #	Price	Length	Width*	Wt.	Cu. Ft.
STU-2-BS	\$4383	31-13/16"	30-5/8"	115 lbs.	26
STU-3-BS	4625	47-1/8"	30-5/8"	143 lbs.	36
STU-4-BS	5483	62-7/16"	30-5/8"	185 lbs.	46
STU-5-BS	6114	77-3/4"	30-5/8"	203 lbs.	56

\*Width Includes 8" Cutting Board



w/ Doors  
STU-5-DR Shown

### w/ Doors

Model #	Price	Length	Width*	Wt.	Cu. Ft.
STU-2-DR	\$4748	31-13/16"	30-5/8"	125 lbs.	26
STU-3-DR	6412	47-1/8"	30-5/8"	153 lbs.	36
STU-4-DR	5980	62-7/16"	30-5/8"	195 lbs.	46
STU-5-DR	6989	77-3/4"	30-5/8"	213 lbs.	56

\*Width Includes 8" Cutting Board

**SU-19** Prepare Hot Tables to be Locked Together **\$539 ea.**

(One Charge For Each Table To Be Interlocked)

**TCB-OMIT** Remove Poly Cutting Board & Shelf **-200 ea.**

**CB-OMIT** Remove Poly Cutting Board Only **-100 ea.**

## Food Table Overshelves

For Our Full Line Of Hot Food Table Modifications, Accessories & Replacement Parts, See Page 136-138



Single Overshelves



Double Overshelves

12" WIDE				18" WIDE				12" WIDE				18" WIDE					
Model	Price	Approx Wt.		Model	Price	Length	Approx Wt.	Cu. Ft.	Model	Price	Approx Wt.		Model	Price	Length	Approx Wt.	Cu. Ft.
STOS-2	\$823	18 lbs.		STOS-2-18	\$1047	31-13/16"	20 lbs.	3	TOS-2	\$1494	32 lbs.		TOS-2-18	\$1776	31-13/16"	35 lbs.	3
STOS-3	935	21 lbs.		STOS-3-18	1128	47-1/8"	23 lbs.	4	TOS-3	1745	38 lbs.		TOS-3-18	2050	47-1/8"	41 lbs.	4
STOS-4	1053	24 lbs.		STOS-4-18	1221	62-7/16"	26 lbs.	5	TOS-4	1993	44 lbs.		TOS-4-18	2343	62-7/16"	47 lbs.	5
STOS-5	1140	27 lbs.		STOS-5-18	1332	77-3/4"	30 lbs.	6	TOS-5	2242	49 lbs.		TOS-5-18	2629	77-3/4"	53 lbs.	6
STOS-6	1390	33 lbs.		STOS-6-18	1625	93-1/8"	35 lbs.	6	TOS-6	2735	56 lbs.		TOS-6-18	3207	93-1/8"	61 lbs.	6

# GOLD WELL DROP-INS

## Drop-In Cold Pan Units

### ICE-COOLED DROP-IN COLD PAN UNITS



- 304 Stainless Steel Top
- 9" Deep Ice Bin With Fiberglass Insulation

- Black Molding with Thermal Breaker
- 1" I.P.S. Drain

	Model #	Price	Length	Width	Cut-Out Size	Ice Capacity	Approx. Wt.	Cu. Ft.
SLIMLINE	DISLCP-2	\$2332	49 5/8"	18-5/8"	17 3/8" x 48-3/8"	93	168 lbs.	11
	DISLCP-3	2816	71 1/4"	18-5/8"	17 3/8" x 70"	141	178 lbs.	18
	DISLCP-4	3215	92 7/8"	18-5/8"	17 3/8" x 91 5/8"	186	215 lbs.	23
STANDARD	DICP-1	1619	18-13/16"	26 3/4"	25 1/2" x 18 5/8"	45	129 lbs.	6
	DICP-2	1919	34-1/8"	26 3/4"	25 1/2" x 32 1/8"	93	162 lbs.	10
	DICP-3	2201	49-7/16"	26 3/4"	25 1/2" x 45 5/8"	141	165 lbs.	14
	DICP-4	2737	64-3/4"	26 3/4"	25 1/2" x 59 1/8"	188	199 lbs.	18
	DICP-5	3159	80-1/8"	26 3/4"	25 1/2" x 72 5/8"	236	240 lbs.	23
	DICP-6	3479	95-3/8"	26 3/4"	25 1/2" x 86 1/8"	284	268 lbs.	27

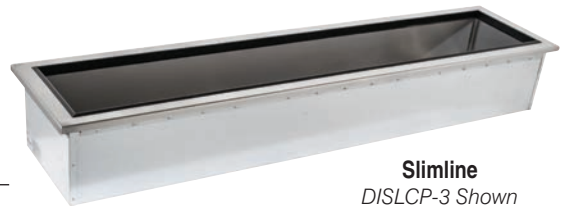

**Slimline**  
DISLCP-3 Shown



**Standard**  
DICP-2 Shown

### Optional Adapter Rails & Bars

DICP SERIES		DISLCP SERIES		Description
Model #	Fits Model:	Model #	Fits Model:	
SU-P-501	DICP-1			Two Left To Right Rails & Two Front-To-Back Supports. Includes Mounting Screws.
SU-P-502	DICP-2	SU-P-512	DISLCP-2	Two Left To Right Rails & Three Front-To-Back Supports. Includes Mounting Screws.
SU-P-503	DICP-3	SU-P-513	DISLCP-3	Two Left To Right Rails & Four Front-To-Back Supports. Includes Mounting Screws.
SU-P-504	DICP-4	SU-P-514	DISLCP-4	Two Left To Right Rails & Five Front-To-Back Supports. Includes Mounting Screws.
SU-P-505	DICP-5			Two Left To Right Rails & Six Front-To-Back Supports. Includes Mounting Screws.
SU-P-506	DICP-6			Two Left To Right Rails & Seven Front-To-Back Supports. Includes Mounting Screws.

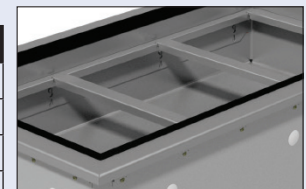

Left To Right Rails & Front To Back Supports Shown Above

**Horizontal Adapter Bars**  
For Small Pan Sizes

12" x 1"  
Model # SU-45A

Works With Required Rail Kits  
(See Grid Above)



### REFRIGERATED DROP-IN COLD PAN UNITS

- 304 Stainless Steel Top
- 9" Deep Ice Bin With Fiberglass Insulation
- Full Insulation Galvanized Outer Jacket
- Black Molding with Thermal Breaker
- High Cooling Capacity
- Sight Glass To Ensure Properly Charges System
- Low Running Current

- 1" I.P.S. Drain
- Precision Thermostat For Exact Temperature Control
- Includes Adapter Bars For 12" X 20" Food Pans (Pans not Included)
- Cord & Plug Included



**Slimline**  
DISLRCP-2 Shown

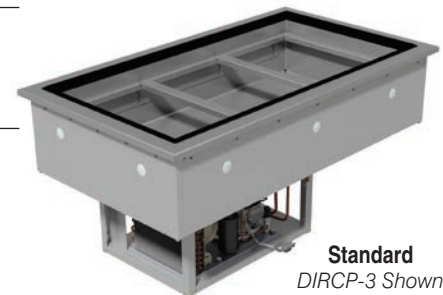

**Standard**  
DIRCP-3 Shown

	Model #	Price	Length	Width	Cut-Out Size	# of Wells	Refrigerant	Approx. Wt.	Cu. Ft.
SLIMLINE	DISLRCP-2	\$6220	49-5/8"	18-5/8"	17-1/8" x 48-3/8"	2	R404-A	205 lbs.	25
	DISLRCP-3	6986	71-1/4"	18-5/8"	15-3/8" x 70"	3	R404-A	257 lbs.	31
	DISLRCP-4	7763	92-7/8"	18-5/8"	17-3/8" x 91-5/8"	4	R404-A	325 lbs.	46
STANDARD	DIRCP-1	4716	20"	26-3/4"	25-1/2" x 18-5/8"	1	R404-A	163 lbs.	14
	DIRCP-2	5041	33-1/2"	26-3/4"	25-1/2" x 32-1/8"	2	R404-A	205 lbs.	22
	DIRCP-3	5535	47"	26-3/4"	25-1/2" x 45-5/8"	3	R404-A	257 lbs.	31
	DIRCP-4	6165	60-1/2"	26-3/4"	25-1/2" x 59-1/8"	4	R404-A	325 lbs.	39
	DIRCP-5	7224	74"	26-3/4"	25-1/2" x 72-5/8"	5	R404-A	365 lbs.	47
	DIRCP-6	7745	87-1/2"	26-3/4"	25-1/2" x 86-1/8"	6	R404-A	398 lbs.	55

**SU-71** 5 Year Extended Parts Warranty on Refrigeration Unit **\$484 Per Unit**  
(Available for Refrigerated Tables & Drop-Ins. See Back Inside Cover For Full Details)



**SU-P-234** - 6' Cord with  
NEMA 5-15P plug Included

**NOTE: Units are not designed to cool foods originally warm. Food should already be chilled to maintain the proper temperatures**



# COLD FOOD TABLES

## Standard Ice-Cooled Tables

- 304 Stainless Steel Body & Top
- Galvanized Legs, Undershelf & Adjustable Bullet Feet
- Enclosed Base Units Include Stainless Steel Body & Shelf
- Fiberglass Insulation
- 1" I.P.S. Drain
- 8" Wide Poly Cutting Board Shelf - Ships K.D.

### Undershelf

Model #	Price	Length	Width*	Wt.	Cu. Ft.
CPU-2	\$1530	31-13/16"	30-5/8"	90 lbs.	12
CPU-3	1980	47-1/8"	30-5/8"	118 lbs.	18
CPU-4	2398	62-7/16"	30-5/8"	150 lbs.	23
CPU-5	2820	77-3/4"	30-5/8"	168 lbs.	29

\*Width Includes 8" Cutting Board



w/ Undershelf  
CPU-3 Shown

### Stainless Steel Legs & Undershelf Upgrade \$692

2 Wells	3 Wells	4 Wells	5 Wells
SU-23A	SU-23B	SU-23C	SU-23D



**SU-5G** Replacement Galvanized Legs with Bullet Foot For Hot/Ice Cooled Table with Undershelf (HF, SW, WB, STU or CPU Series) **69 ea.**

**Optional Adapter Bars**

12" x 1"	20" x 3"
<b>Model # SU-45A</b>	<b>Model # SU-45B</b>
<b>\$55 ea.</b>	<b>\$61 ea.</b>



### Enclosed Base

Model #	Price	Length	Width*	Wt.	Cu. Ft.
CPU-2-BS	\$3801	31-13/16"	30-5/8"	115 lbs.	18
CPU-3-BS	4508	47-1/8"	30-5/8"	143 lbs.	34
CPU-4-BS	5332	62-7/16"	30-5/8"	227 lbs.	44
CPU-5-BS	5631	77-3/4"	30-5/8"	203 lbs.	54

\*Width Includes 8" Cutting Board

**Enclosed Base**  
CPU-5-BS Shown  
with Optional  
Caster Kit



### w/ Doors

Model #	Price	Length	Width*	Wt.	Cu. Ft.
CPU-2-DR	\$4006	31-13/16"	30-5/8"	125 lbs.	24
CPU-3-DR	4802	47-1/8"	30-5/8"	153 lbs.	34
CPU-4-DR	5755	62-7/16"	30-5/8"	195 lbs.	44
CPU-5-DR	6126	77-3/4"	30-5/8"	213 lbs.	54

\*Width Includes 8" Cutting Board

**W/ Doors**  
CPU-5-DR  
Shown

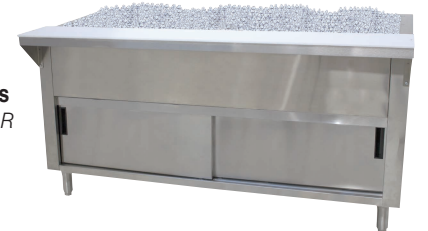

**NOTE: Units are not designed to cool foods originally warm. Food should already be chilled to maintain the proper temperatures**



### CONNECT IT!

Prepare Tables To Be Locked Together While Keeping Them Lined Up! (One Charge For Each Table To Be Interlocked)  
**SU-19 \$539 per table**

## Sleek Shields™

Protected By: Patent No. US 9,010,883 B2

### Self-Serve Style

- 18" Standard Height (Top of Table To Top)
- 1" Stainless Steel Tubing Posts (1 5/8" Posts Also Available)
- Includes Two 18" W x 16 3/8" H Glass Side Panels
- 1/4" Thick Heat-Tempered Glass Front & Sides
- Shipped KD

## GLASS FOOD SHIELDS

Mounts To Top Of Hot/Cold Food Table

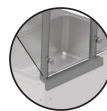

**Includes TA-47 Mounting Brackets**  
For In-Field Installation



**Chamber Lock™**  
Allows Front Glass To Lock In Place At 15° Intervals

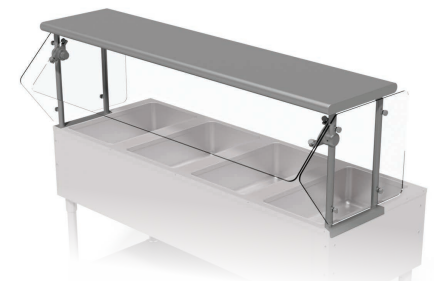

NSG-15-4WELL Shown

15" Wide Stainless Steel Shelf			15" Wide w/ Glass Top			Fits # of Bowls	Approx. Wt.	Approx. Cubes
Model #	Price	O.A. Size L x W x H	Model #	Price	O.A. Size L x W x H			
NSG-15-2WELL	\$3291	33 11/16" x 19 3/4" x 18 3/4"	GSG-15-2WELL	\$3949	33 11/16" x 19 3/4" x 18"	Fits 2-Well Unit	109 lbs.	15
NSG-15-3WELL	3426	49" x 19 3/4" x 18 3/4"	GSG-15-3WELL	4097	49" x 19 3/4" x 18"	Fits 3-Well Unit	143 lbs.	22
NSG-15-4WELL*	4010	64 5/16" x 19 3/4" x 18 3/4"	GSG-15-4WELL*	4359	64 5/16" x 19 3/4" x 18"	Fits 4-Well Unit	186 lbs.	29
NSG-15-5WELL**	4380	79 5/8" x 19 3/4" x 18 3/4"	Not Available	Not Available	Not Available	Fits 5-Well Unit	215 lbs.	38
NSG-15-6WELL**	4850	94 15/16" x 19 3/4" x 18 3/4"	Not Available	Not Available	Not Available	Fits 6-Well Unit	247 lbs.	47

GSG Series Food Shields are slightly longer than the table they rest on. They will extend about 7/8" on either end

\*3/8" Thick Heat-Tempered Glass Required For Front Glass

\*\*Requires a Single Center Post (Factory Print Included)

**For Full Line Of Glass Top Food Shields & Food Table Accessories, See Page 135-137.**

# COLD FOOD TABLES

## Mechanically Assisted Cold Pan Tables



### REFRIGERATED COLD PAN TABLES

- 304 Stainless Steel Body, Top and Legs
- Adjustable Bullet Feet
- Heavy Duty Cabinet Base
- 8" Wide Poly Cutting Board Shelf - Ships K.D.
- 1" I.P.S. Drain
- Precision Thermostat For Exact Temperature Control
- High Cooling Capacity
- Sight Glass To Ensure Properly Charges System
- Low Running Current



**Enclosed Base**  
MACP-3-BS Shown



**Sliding Doors**  
MACP-3-DR Shown



**SU-P-234** - 6' Cord with  
**NEMA 5-15P** plug Included

#### Enclosed Base

Model #	Price	Length	Width*	Refrigerant	Wt.	Cu. Ft.
MACP-2-BS	\$9372	31-3/16"	30-5/8"	R404-A	230 lbs.	39
MACP-3-BS	10582	47-1/8"	30-5/8"	R404-A	256 lbs.	56
MACP-4-BS	11436	62-7/16"	30-5/8"	R404-A	380 lbs.	73
MACP-5-BS	12478	77-3/4"	30-5/8"	R404-A	465 lbs.	90

\*Width Includes 8" Cutting Board

#### w/ Sliding Doors

Model #	Price	Length	Width*	Refrigerant	Wt.	Cu. Ft.
MACP-3-DR	\$10983	47-1/8"	30-5/8"	R404-A	385 lbs.	41
MACP-4-DR	12717	62-7/16"	30-5/8"	R404-A	420 lbs.	73
MACP-5-DR	13924	77-3/4"	30-5/8"	R404-A	505 lbs.	90

\*Width Includes 8" Cutting Board

**SU-71** 5 Year Extended Parts Warranty on Refrigeration Unit **\$484 Per Unit**  
(Available for Refrigerated Tables & Drop-Ins. See Back Inside Cover For Full Details)

#### Cold Pan Table Covers

- Stainless Steel
- Plastic Handles
- Piano Hinge(s)
- Fits CPU, DICP  
MACP & BMAPC  
Units

Model #	Price	Length	Wt.	Cu. Ft.
HC-2	\$377	28-9/16"	12 lbs.	3
HC-3	564	43-7/8"	16 lbs.	4
HC-4	617	59-3/16"	20 lbs.	5
HC-5	717	74-1/2"	24 lbs.	6

**NOTE: Units are not designed to cool foods originally warm. Food should already be chilled to maintain the proper temperatures**

**WARNING:** Refrigerated Equipment on this page may expose you to chemicals, including Ethanes, that are known to the State of California to cause cancer or birth defects or other reproductive harm. For more Info., visit [www.p65warnings.ca.gov](http://www.p65warnings.ca.gov).

## Food Table Shelving

For Our Full Line Of Hot Food Table Modifications, Accessories & Replacement Parts, See Page 136-138

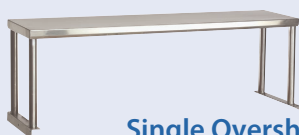

15" Height

#### Single Overshelves

12" WIDE						18" WIDE									
Model	Price	Approx Wt.	Model	Price	Length	Approx Wt.	Cu. Ft.	Model	Price	Length	Approx Wt.	Cu. Ft.			
STOS-2	\$823	18 lbs.	STOS-2-18	\$1047	31-13/16"	20 lbs.	3	TOS-2	\$1494	32 lbs.	TOS-2-18	\$1776	31-13/16"	35 lbs.	3
STOS-3	935	21 lbs.	STOS-3-18	1128	47-1/8"	23 lbs.	4	TOS-3	1745	38 lbs.	TOS-3-18	2050	47-1/8"	41 lbs.	4
STOS-4	1053	24 lbs.	STOS-4-18	1221	62-7/16"	26 lbs.	5	TOS-4	1993	44 lbs.	TOS-4-18	2343	62-7/16"	47 lbs.	5
STOS-5	1140	27 lbs.	STOS-5-18	1332	77-3/4"	30 lbs.	6	TOS-5	2242	49 lbs.	TOS-5-18	2629	77-3/4"	53 lbs.	6
STOS-6	1390	33 lbs.	STOS-6-18	1625	93-1/16"	35 lbs.	6	TOS-6	2242	56 lbs.	TOS-6-18	2629	93-1/16"	61 lbs.	6

12" Height



15" Height

#### Double Overshelves

## Food Table Accessories

- SU-255** Add Casters to Food Units w/Undershelf **\$394 Set of 4**  
(Includes 4 - 5" Bolted Swivel Casters, 2 w/ Brakes)
- SU-25** Add Casters to Food Units w/Undershelf **394 Set of 4**  
(For Units Built Before October 2015. Includes 4 - 5" Swivel Casters, 2 w/ Brakes.)
- TA-25** Replacement Casters For Undershelf Units **394 Set of 4**  
(For Units Built After October 2015. Includes 4 - 5" Swivel Casters, 2 w/ Brakes.)
- TA-255P** Add Casters to Enclosed Base Food Units **636 Set of 4**  
(Includes 4 - 5" Bolted Swivel Casters, 2 w/ Brakes)
- SU-19** Prepare Hot Tables to be Locked Together **\$539 ea.**  
(One Charge For Each Table To Be Interlocked)
- SU-45A** 12" x 1" Adapter Bar **55 ea.**
- SU-45B** 20" x 3" Adapter Bar **61 ea.**
- TCB-OMIT** Remove Poly Cutting Board & Shelf **-200 ea.**
- CB-OMIT** Remove Poly Cutting Board Only **-100 ea.**

**Sleek Shields™ Are Also Available For Hot & Cold Food Tables. See Pages 136 For Details.**

# HEAVY DUTY TABLES

## Heavy Duty Tables

### HEAVY DUTY ELECTRIC SEALED WELL TABLES

- Heavy Duty Construction 300 Stainless Steel Body, Top and Legs
- Adjustable Stainless Steel Bullet Feet
- 8" Wide Poly Cutting Board Shelf - Ships K.D.
- Sealed Wells w/ Manifold Drains
- Thermostatic Controls
- 6 Ft. Electric Cord w/ Plug Included
- Control Knobs & Indicator Lights
- Removable Front Panel To Access Elements (Upgrade to 3 Phase Wiring for 240 Volt Units- Model # SU-72 \$470)



**Enclosed Base**  
HDSW-3-240-BS Shown  
with Optional TA-255P Casters



#### Enclosed Base

Model #	Price	Length	Width*	# of Wells	Volts	Amps	Watts	Wt.	Cu. Ft.
HDSW-2-120-BS	\$8888	31-13/16"	35-3/4"	2	120	10.67	1280	225	31
HDSW-3-120-BS	10709	47-1/8"	35-3/4"	3	120	16	1920	340	45
HDSW-4-120-BS	12319	62-7/16"	35-3/4"	4	120	21.33	2560	430	60
HDSW-2-240-BS	8888	31-13/16"	35-3/4"	2	208/240	7.94/9.16	1650/2200	225	31
HDSW-3-240-BS	10709	47-1/8"	35-3/4"	3	208/240	11.91/13.74	2475/3300	340	45
HDSW-4-240-BS	12319	62-7/16"	35-3/4"	4	208/240	15.88/18.32	3300/4400	430	60
HDSW-5-240-BS	16077	77-3/4"	35-3/4"	5	208/240	19.85/22.90	4125/5500	520	74
HDSW-6-240-BS	18764	93-1/16"	35-3/4"	6	208/240	23.82/27.48	4850/6600	610	88

\*Width Includes 8" Cutting Board

**NOTE: Units are not designed to cook or heat frozen or refrigerated foods. Food placed in tables should already be hot, and the table will maintain the proper temperatures**

#### Autofill Upgrade

Automatically fills & maintains water level. For DISW, DISLSW, SW & HDSW Series. Requires added cost Manifold Drain Assembly (Except HDSW series). See page 122.

**SU-90 \$1980 Upgrade**



#### Filler Faucet

- Hot Water Supply Only 6" Spout
- Faucet Location To Be Specified When Ordering
- Requires -M Manifold Drain Assembly
- Add **SU-15 \$726** for Filler Faucet Provision



**K-49 \$371**

### HEAVY DUTY Refrigerated Cold Well Tables

- Heavy Duty Construction 300 Stainless Steel Body, Top & Legs
- Adjustable Stainless Steel Bullet Feet
- Heavy Duty Cabinet Base
- 1" I.P.S. Drain
- Poly Cutting Board Shelf - Ships K.D.
- High Cooling Capacity
- Includes Adapter Bars For Optional Spillage Pans
- Low Running Current
- Precision Thermostat For Exact Temperature Control
- Single Phase Wiring



**Enclosed Base**  
HDRCP-3-BS Shown  
with Optional TA-255P Casters

Model #	Price	Length	Width*	Refrigerant	Wt.	Cu. Ft.
HDRCP-2-BS	\$13794	31-13/16"	36-1/4"	R404-A	300 lbs.	39
HDRCP-3-BS	14468	47-1/8"	36-1/4"	R404-A	420 lbs.	56
HDRCP-4-BS	16077	62-7/16"	36-1/4"	R404-A	510 lbs.	73
HDRCP-5-BS	18756	77-3/4"	36-1/4"	R404-A	568 lbs.	90
HDRCP-6-BS	20631	93-1/16"	36-1/4"	R404-A	633 lbs.	90

\*Width Includes 8" Cutting Board

**SU-71** 5 Year Extended Parts Warranty on Refrigeration Unit **\$484 Per Unit**  
(Available for Refrigerated Tables & Drop-Ins. See Back Inside Cover For Full Details)



#### CONNECT IT!

Prepare Tables To Be Locked Together While Keeping Them Lined Up!  
(One Charge For Each Table To Be Interlocked)

**SU-19 \$539 per table**

**WARNING:** Refrigerated Equipment on this page may expose you to chemicals, including Ethanes, that are known to the State of California to cause cancer or birth defects or other reproductive harm. For more info., visit [www.p65warnings.ca.gov](http://www.p65warnings.ca.gov).

### HEAVY DUTY ICE-COOLED TABLES

- Stainless Steel Body, Top And Legs
- Adjustable Stainless Steel Bullet Feet
- High Cooling Capacity
- Heavy Duty Cabinet Base
- 8" Wide Poly Cutting Board Shelf - Ships K.D.



**Enclosed Base**  
HDCPU-3-BS Shown  
with Optional TA-255P Casters



#### Enclosed Base

Model #	Price	Length	Width*	Wt.	Cu. Ft.
HDCPU-2-BS	\$6754	31-13/16"	36-1/4"	117 lbs.	27
HDCPU-3-BS	7994	47-1/8"	36-1/4"	145 lbs.	39
HDCPU-4-BS	8644	62-7/16"	36-1/4"	205 lbs.	58
HDCPU-5-BS	10711	77-3/4"	36-1/4"	250 lbs.	69
HDCPU-6-BS	11727	93-1/16"	36-1/4"	295 lbs.	81

#### With Doors

Model #	Price	Length	Width*	Wt.	Cu. Ft.
HDCPU-2-DR	\$6975	31-13/16"	36-1/4"	127 lbs.	27
HDCPU-3-DR	8409	47-1/8"	36-1/4"	155 lbs.	39
HDCPU-4-DR	8901	62-7/16"	36-1/4"	215 lbs.	58
HDCPU-5-DR	11091	77-3/4"	36-1/4"	264 lbs.	69
HDCPU-6-DR	12202	93-1/16"	36-1/4"	309 lbs.	81

\*Width Includes 8" Cutting Board

See Pages 135-137 For Shelving & Accessories! For Shelving on 6 Well Units, Please Consult Our Smart Fabrication™ Dept.

# BUFFET TABLES

## Everyday Buffet Hot Food Tables

For Use with Optional Spillage Pans

- Stainless Steel Top And Body
- Matte Black Vinyl Clad
- 8" Deep Liners For Optional **SP-A** Or **SP-S** Spillage Pans
- 1/4" Thick, Double Sided Thermoplastic Polymer Sneeze Guard & Side Panels
- 4" Swivel Casters, Two With Brakes
- Fiberglass Insulation
- Pre-Drilled For Optional Solid Drop-Down Tray Shelf available for one or both sides

- Infinite Control Knobs
- Indicator Lights
- 6' Electrical Cord With Plug
- Single Phase Wiring (Upgrade to 3 Phase Wiring for 240 Volt Units- **Model # SU-72 \$470**)
- To Omit Sneeze Guard use **Model # BSG-OMIT** deduct \$350

### Open Base

Galvanized Liners	Price	Stainless Steel Liners	Price	Length	# of Wells	NEMA Plug	Volts	Amps	Watts	Wt.	Cu. Ft.
<b>B2-120-B</b>	<b>\$4111</b>	<b>B2-120-B-S</b>	<b>\$4608</b>	31-13/16"	2	5-20P	120	8.33	1000	135 lbs.	39
<b>B3-120-B</b>	<b>4366</b>	<b>B3-120-B-S</b>	<b>4831</b>	47-1/8"	3	5-20P	120	12.50	1500	246 lbs.	56
<b>B4-120-B</b>	<b>5107</b>	<b>B4-120-B-S</b>	<b>5581</b>	62-7/16"	4	L5-30P	120	16.67	2000	301 lbs.	73
<b>B2-240-B</b>	<b>4111</b>	<b>B2-240-B-S</b>	<b>4608</b>	31-13/16"	2	6-20P	208/240	7.21/8.33	1500/2000	135 lbs.	39
<b>B3-240-B</b>	<b>4366</b>	<b>B3-240-B-S</b>	<b>4831</b>	47-1/8"	3	6-20P	208/240	10.82/12.50	2250/3000	170 lbs.	57
<b>B4-240-B</b>	<b>5107</b>	<b>B4-240-B-S</b>	<b>5581</b>	62-7/16"	4	L6-30P	208/240	14.42/16.67	3000/4000	310 lbs.	73
<b>B5-240-B</b>	<b>6297</b>	<b>B5-240-B-S</b>	<b>6597</b>	77-3/4"	5	L6-30P	208/240	18.03/20.84	3750/5000	343 lbs.	90



**Open Base**  
B3-120-B-S Shown

### Enclosed Base

Galvanized Liners	Price	Stainless Steel Liners	Price	Length	# of Wells	NEMA Plug	Volts	Amps	Watts	Wt.	Cu. Ft.
<b>B2-120-B-SB</b>	<b>\$5132</b>	<b>B2-120-B-S-SB</b>	<b>\$5380</b>	31-13/16"	2	5-20P	120	8.33	1000	135 lbs.	39
<b>B3-120-B-SB</b>	<b>5681</b>	<b>B3-120-B-S-SB</b>	<b>6054</b>	47-1/8"	3	5-20P	120	12.50	1500	170 lbs.	56
<b>B4-120-B-SB</b>	<b>6229</b>	<b>B4-120-B-S-SB</b>	<b>6859</b>	62-7/16"	4	L5-30P	120	16.67	2000	310 lbs.	73
<b>B2-240-B-SB</b>	<b>5132</b>	<b>B2-240-B-S-SB</b>	<b>5380</b>	31-13/16"	2	6-20P	208/240	7.21/8.33	1500/2000	135 lbs.	39
<b>B3-240-B-SB</b>	<b>5681</b>	<b>B3-240-B-S-SB</b>	<b>6054</b>	47-1/8"	3	6-20P	208/240	10.82/12.50	2250/3000	170 lbs.	56
<b>B4-240-B-SB</b>	<b>6229</b>	<b>B4-240-B-S-SB</b>	<b>6859</b>	62-7/16"	4	L6-30P	208/240	14.42/16.67	3000/4000	210 lbs.	73
<b>B5-240-B-SB</b>	<b>7166</b>	<b>B5-240-B-S-SB</b>	<b>7723</b>	77-3/4"	5	L6-30P	208/240	18.03/20.84	3750/5000	235 lbs.	90



**Enclosed Base**  
B3-120-B-SB Shown

## BUFFET TABLE SEALED WELL WITH ENCLOSED BASE

- Stainless Steel Top And Body
- Stainless Steel Sealed Wells with Manifold Drains
- Matte Black Vinyl Clad
- 10 Gauge Aluminum Dome Shape Heat Element
- 20 Gauge Stainless Steel Deep Drawn Bowls With 1" Drain
- 1/4" Thick, Double Sided Thermoplastic Polymer Sneeze Guard And Side Panels
- 4" Swivel Casters, Two With Brakes
- Fiberglass Insulation

- Optional Solid Drop-Down Tray Shelf available for one or both sides
- Infinite Control Knobs
- Indicator Lights
- Single Phase Wiring
- Single Phase Wiring (Upgrade to 3 Phase Wiring for 240 Volt Units- **Model # SU-72 \$470**)
- 6' Electrical Cord With Plug
- To Omit Sneeze Guard use **Model # BSG-OMIT** deduct \$350

### Enclosed Base

Stainless Steel Liners	Price	Length	# of Wells	NEMA Plug	Volts	Amps	Watts	Wt.	Cu. Ft.
<b>BSW2-120-B-SB</b>	<b>\$6105</b>	31-13/16"	2	5-20P	120	10.67	1280	300 lbs.	30
<b>BSW3-120-B-SB</b>	<b>6516</b>	47-1/8"	3	5-20P	120	16	1920	325 lbs.	43
<b>BSW4-120-B-SB</b>	<b>7348</b>	62-7/16"	4	L5-30P	120	21.33	2560	356 lbs.	55
<b>BSW2-240-B-SB</b>	<b>6105</b>	31-13/16"	2	6-20P	208/240	7.94/9.16	1650/2200	300 lbs.	30
<b>BSW3-240-B-SB</b>	<b>6516</b>	47-1/8"	3	6-20P	208/240	11.91/13.74	2475/3300	325 lbs.	43
<b>BSW4-240-B-SB</b>	<b>7348</b>	62-7/16"	4	L6-30P	208/240	15.88/18.32	3300/4400	356 lbs.	55
<b>BSW5-240-B-SB</b>	<b>8574</b>	77-3/4"	5	L6-30P	208/240	19.85/22.90	4125/5500	370 lbs.	68



**Enclosed Base**  
BSW3-120-B-SB Shown

**NOTE: Units are not designed to cook or heat frozen or refrigerated foods. Food placed in tables should already be hot, and the table will maintain the proper temperatures**

See Pages 135-137 For Shelving & Accessories!

### END SHELF FOR HOT/COLD TABLES

(Excludes HDSW, HDRCP & HDCPU Units)

- 10" Wide x 22 1/2" Length
- Stainless Steel

**Stationary** **Drop-Down**  
**TES-1** **TES-1D**  
**\$690** **\$815**





# BUFFET TABLES

## Everyday Buffet Ice-Cooled Tables

For Use with Optional Spillage Pans

- Stainless Steel Top And Body
- Matte Black Vinyl Clad
- 8" Deep Liners With Adapter Bars For Optional **SP-A** Or **SP-S** Spillage Pans
- 1/4" Thick, Double Sided Thermoplastic Polymer Sneeze Guard And Side Panels
- 4" Swivel Casters, Two With Brakes
- Fiberglass Insulation
- Pre-Drilled For Optional Solid Drop-Down Tray Shelf available for one or both sides
- To Omit Sneeze Guard use **Model # BSG-OMIT** deduct \$350

### Open Base

Model	Price	Length	# of Wells	Wt.	Cu. Ft.
<b>B2-CPU-B</b>	<b>\$3854</b>	31-13/16"	2	225 lbs.	53
<b>B3-CPU-B</b>	<b>4216</b>	47-1/8"	3	250 lbs.	76
<b>B4-CPU-B</b>	<b>4579</b>	62-7/16"	4	310 lbs.	97
<b>B5-CPU-B</b>	<b>5245</b>	77-3/4"	5	350 lbs.	119



**Open Base**  
B3-CPU-B Shown

### Enclosed Base

Model	Price	Length	# of Wells	Wt.	Cu. Ft.
<b>B2-CPU-B-SB</b>	<b>\$4352</b>	31-13/16"	2	235 lbs.	53
<b>B3-CPU-B-SB</b>	<b>4512</b>	47-1/8"	3	260 lbs.	76
<b>B4-CPU-B-SB</b>	<b>4934</b>	62-7/16"	4	320 lbs.	97
<b>B5-CPU-B-SB</b>	<b>5706</b>	77-3/4"	5	360 lbs.	119



**Enclosed Base**  
B3-CPU-B-SB Shown

**NOTE: Units are not designed to cool foods originally warm. Food should already be chilled to maintain the proper temperatures**

## Everyday Buffet Tables with Solid Top

- Stainless Steel Top And Body
- Solid Stainless Steel Top
- Matte Black Vinyl Clad
- 1/4" Thick, Double Sided Thermoplastic Polymer Sneeze Guard on top and side panels and Side Panels
- 4" Swivel Casters, Two With Brakes
- Optional Solid Drop-Down Tray Shelf available for one or both sides
- To Omit Sneeze Guard use **Model # BSG-OMIT** deduct \$350

### Open Base

Model	Price	Length	Wt.	Cu. Ft.
<b>B2-STU-B</b>	<b>\$3985</b>	31-13/16"	260 lbs.	53
<b>B3-STU-B</b>	<b>4261</b>	47-1/8"	300 lbs.	76
<b>B4-STU-B</b>	<b>4787</b>	62-7/16"	330 lbs.	97
<b>B5-STU-B</b>	<b>5474</b>	77-3/4"	370 lbs.	119



**Open Base**  
B3-STU-B Shown

### ENCLOSED BASE

Model	Price	Length	Wt.	Cu. Ft.
<b>B2-STU-B-SB</b>	<b>\$4236</b>	31.8125"	270 lbs.	53
<b>B3-STU-B-SB</b>	<b>4785</b>	47.125"	310 lbs.	76
<b>B4-STU-B-SB</b>	<b>5336</b>	62.4375"	340 lbs.	97
<b>B5-STU-B-SB</b>	<b>5635</b>	77.75"	380 lbs.	119



**Enclosed Base**  
B3-STU-B-SB Shown

**See Pages 134-138 For Shelving & Accessories!**

# BUFFET TABLES

## Mechanically Assisted Everyday Buffet Tables

For Use with Optional Spillage Pans



### COLD PAN TABLES WITH ENCLOSED BASE

- Stainless Steel Top, Liner And Body
- Self contained condensing unit provided with a hermetically sealed compressor with a digital, programmable thermostat
- Full Insulation With 22 Gauge Galvanized Outer Jacket
- Removable access door to compressor
- Fiberglass Insulation
- High Cooling Capacity
- Sight Glass To Ensure Properly Charges System
- Low Running Current
- Precision Thermostat For Exact Temperature Control
- 1" I.P.S. Drain

- 1/4" Thick, Double Sided Thermoplastic Polymer Sneeze Guard And Side Panels
- 4" Swivel Casters, Two With Brakes
- Includes Food Pan Adapters For optional 12" X 20" Pans
- Matte Black Vinyl Clad
- Pre-Drilled For Optional Solid Drop-Down Tray Shelf available for one or both sides
- Single Phase Wiring
- 6' Electrical Cord With Plug
- To Omit Sneeze Guard use **Model # BSG-OMIT** deduct \$350



**Enclosed Base**  
BMACP3-B-SB Shown

Model	Price	Length	# of Wells	NEMA Plug	Refrigerant	Wt.	Cu. Ft.
BMACP2-B-SB	\$9788	31-13/16"	2	5-20P	R404-A	250 lbs.	30
BMACP3-B-SB	10460	47-1/8"	3	5-20P	R404-A	300 lbs.	43
BMACP4-B-SB	10999	62-7/16"	4	5-20P	R404-A	345 lbs.	55
BMACP5-B-SB	11713	77-3/4"	5	5-20P	R404-A	395 lbs.	68

**NOTE: Units are not designed to cook or heat frozen or refrigerated foods. Food placed in tables should already be hot, and the table will maintain the proper temperatures**

**SU-71** 5 Year Extended Parts Warranty on Refrigeration Unit  
(Available for Refrigerated Tables & Drop-Ins. See Back Inside Cover For Full Details)

**\$484 Per Unit**



#### CONNECT IT!

Prepare Tables To Be Locked Together  
While Keeping Them Lined Up!  
(One Charge For Each Table To Be Interlocked)  
**SU-19 \$539** per table

**WARNING:** Refrigerated Equipment on this page may expose you to chemicals, including Ethanes, that are known to the State of California to cause cancer or birth defects or other reproductive harm. For more info, visit [www.p65warnings.ca.gov](http://www.p65warnings.ca.gov).

### PORTABLE CASH REGISTER STANDS WITH DRAWER & KEY LOCK

- 20 Gauge, 304 Stainless Steel Frame
- Locking Drawer
- 4" Swivel Casters With Two Brakes
- Open Storage Area
- Access Hole For Power Cord
- Matte Black Vinyl Clad

(Cash Register not included)



Model	Price	Length	Width	Height	Wt.	Cu. Ft.
BCRS-B	\$2406	22 1/2"	22 1/2"	34 3/8"	140 lbs.	19

### WITH LOCKING DOOR

- Stainless Steel Interior, Frame And Bottom
- Adjustable Hinges & Locking Door w/ Key
- Full Perimeter Bumpers
- Mid-Shelf
- Black Mica Finish On Door, Top & Sides
- Open Bottom Shelf For Glass Rack Storage
- 4" Swivel Casters With Two Brakes



Model	Price	Length	Width	Height	Wt.	Cu. Ft.
AMD-2B	\$2179	24.5"	23.5"	40.5"	160 lbs.	27

### EVERYDAY BUFFET SILVERWARE STAND

- 20 Gauge, 304 Stainless Steel Frame
- Includes 12 Plastic Silverware Cups
- 4" Swivel Casters With Two Brakes
- Matte Black Vinyl Clad

(Trays & silverware shown not included)



Model	Price	Length	Width	Height	Wt.	Cu. Ft.
BSWS-B	\$2932	31.875"	22.4"	40"	160 lbs.	28

### Food Table Modifications & Accessories

For Our Full Line Of Hot Food Table Modifications, Accessories & Replacement Parts, See Page 136-138

<b>TCB-OMIT</b>	Remove Poly Cutting Board	-\$200 ea.	<b>SU-6</b>	Hot/Cold Food Table Handle	\$169 ea.
<b>CB-OMIT</b>	Remove Poly Cutting Board Only	-100 ea.	<b>SU-19</b>	Prepare Hot Tables To Be Locked Together (One Charge For Each Table To Be Interlocked)	539 ea.
<b>SU-45A</b>	12" x 1" Adapter Bar	55 ea.	<b>SU-72</b>	Upgrade 240 volt units to 3-Phase Wiring	470 ea.
<b>SU-45B</b>	20" x 3" Adapter Bar	61 ea.			
<b>SP-A</b>	Aluminum Spillage Pan	125 ea.			
<b>SP-S</b>	Stainless Steel Spillage Pan	219 ea.			





# ACCESSORIES

## Hot/Cold Food Table Shelving

### TRAY SHELVES

#### 10" Wide Stainless Steel Tray Shelves



STATIONARY		DROP-DOWN		Length	Approx Wt.	Cu. Ft.
Model	Price	Model	Price			
TTS-2	\$722	TTS-2D	\$847	31-13/16"	15 lbs.	3
TTS-3	852	TTS-3D	985	47-1/8"	17 lbs.	4
TTS-4	872	TTS-4D	1049	62-7/16"	19 lbs.	5
TTS-5	1047	TTS-5D	1171	77-3/4"	22 lbs.	6
TTS-6	1276	TTS-6D	1428	93-1/16"	25 lbs.	6

#### 12" Wide Stainless Steel Tray Rails



STATIONARY		DROP-DOWN		Length	Approx Wt.	Cu. Ft.
Model	Price	Model	Price			
TTR-2	\$655	TTR-2D	\$767	31-13/16"	14 lbs.	3
TTR-3	805	TTR-3D	923	47-1/8"	16 lbs.	4
TTR-4	904	TTR-4D	990	62-7/16"	18 lbs.	5
TTR-5	1050	TTR-5D	1140	77-3/4"	21 lbs.	6
TTR-6	1281	TTR-6D	1390	93-1/16"	23 lbs.	6

#### 8" WIDE SHELF

With Removable  
3/8" Thick Poly Cutting Board



- All Stainless Steel Construction
- Cutting Board Attaches To Top Shelf Using Acorn Nuts

Model	Price	Length	Approx Wt.	Cu. Ft.
TCB-2	\$311	31-13/16"	16 lbs.	3
TCB-3	423	47-1/8"	19 lbs.	4
TCB-4	530	62-7/16"	23 lbs.	5
TCB-5	617	77-3/4"	26 lbs.	6

**TCB-OMIT** Remove Poly Cutting Board & Shelf **-\$200 ea.**  
**CB-OMIT** Remove Poly Cutting Board Only **-100 ea.**

#### Replacement 3/8" Poly Cutting Boards

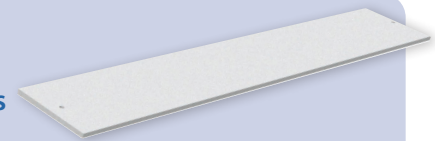

Model	Price	Length	Approx Wt.
SU-P-342	\$165	31-13/16"	9 lbs.
SU-P-343	200	47-1/8"	11 lbs.
SU-P-344	226	62-7/16"	13 lbs.
SU-P-345	240	77-3/4"	15 lbs.
SU-P-346	275	93-1/16"	18 lbs.

#### 7" WIDE DISH SHELF

Connects To TCB Series Shelf

Includes 2 Side Panels & Lower Shelf



Poly Cutting Board & Top Shelf Not Included

Model	Price	Length	Approx Wt.	Cu. Ft.
TDS-2	\$573	31-13/16"	20 lbs.	3
TDS-3	684	47-1/8"	27 lbs.	4
TDS-4	904	62-3/8"	31 lbs.	5
TDS-5	1042	77-3/4"	38 lbs.	6

#### END SHELF FOR HOT/COLD TABLES

(Excludes HDRCP, HDSW & HDCPU Units)

- 10" Wide x 22 1/2" Length
- Stationary or Drop-Down
- All Stainless Steel Construction



STATIONARY		DROP-DOWN		Approx Wt.	Cu. Ft.
Model	Price	Model	Price		
TES-1	\$690	TES-1D	\$815	15 lbs.	3

#### TABLE MOUNTED OVERSHELVES

- **TOS Series:** Upper Shelf Secures To Lower Shelf With Expander Hardward (Included)
- Shipped KD

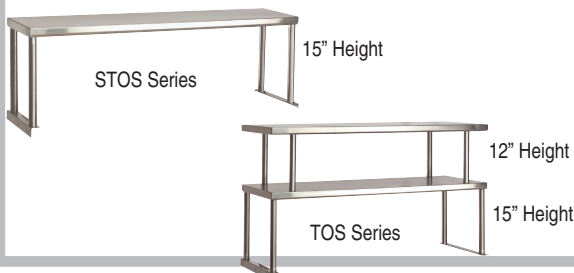

12" Wide			18" Wide				
Model	Price	Approx Wt.	Model	Price	Approx Wt.	Length	Cu. Ft.
<b>Single Tier</b>							
STOS-2	\$823	18 lbs.	STOS-2-18	\$1047	20 lbs.	31-13/16"	3
STOS-3	935	21 lbs.	STOS-3-18	1128	23 lbs.	47-1/8"	4
STOS-4	1053	24 lbs.	STOS-4-18	1221	26 lbs.	62-7/16"	5
STOS-5	1140	27 lbs.	STOS-5-18	1332	30 lbs.	77-3/4"	6
STOS-6	1390	33 lbs.	STOS-6-18	1625	35 lbs.	93-1/16"	6
<b>Double Tier</b>							
TOS-2	1494	32 lbs.	TOS-2-18	1776	35 lbs.	31-13/16"	3
TOS-3	1745	38 lbs.	TOS-3-18	2050	56 lbs.	47-1/8"	4
TOS-4	1993	44 lbs.	TOS-4-18	2343	47 lbs.	62-7/16"	5
TOS-5	2242	49 lbs.	TOS-5-18	2629	53 lbs.	77-3/4"	6
TOS-6	2735	56 lbs.	TOS-6-18	3207	61 lbs.	93-1/16"	6

# ACCESSORIES

## Hot/Cold Food Table Food Shields



Meets Latest NSF Standards

### Sleek Shields™

Protected By: Patent No. US 9,010,883 B2



FEATURING ADVANCE TABCO'S REVOLUTIONARY CHAMBER LOCK™ ROTATION SYSTEM

Front Glass Locks Into Place At 15° Intervals

For Double Sided Sleek Shields™  
On Everyday Buffets Please Consult Factory

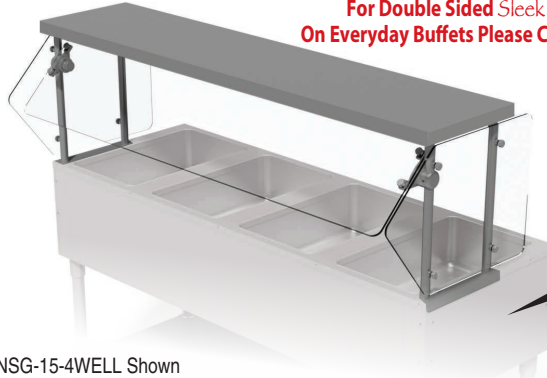

NSG-15-4WELL Shown

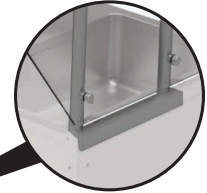

Includes TA-47  
Mounting Brackets  
For In-Field Installation

### GLASS FOOD SHIELDS

Mounts To Top Of Hot/Cold Food Tables On Pg. 123-130  
(Excluding Drop-In Wells)

- 18 3/4" Standard Height (Top of Table To Top)
- 15" Wide Glass Top or Stainless Steel Shelf  
NSG/NSGC Models: Shelves Have Square Edges On All Four Sides.  
GSG Models: Glass Top Features 3/8" Heat-Tempered Glass Top
- 1" Stainless Steel Tubing Posts
- Includes Two 18" Wide x 16 3/8" High Glass Side Panels
- 1/4" Thick Heat-Tempered Glass Front & Sides\*
- Ships KD

#### Self-Serve - Single Side

15" Wide Stainless Steel Shelf			15" Wide w/ Glass Top			Fits # of Bowls	Approx. Wt.	Approx. Cubes
Model #	Price	O.A. Size L x W x H	Model #	Price	O.A. Size L x W x H			
NSG-15-2WELL	\$3291	33 11/16" x 19 3/4" x 18 3/4"	GSG-15-2WELL	\$3949	34 11/16" x 19 3/4" x 18"	Fits 2-Well Unit	109 lbs.	15
NSG-15-3WELL	3426	49" x 19 3/4" x 18 3/4"	GSG-15-3WELL	4097	49" x 19 3/4" x 18"	Fits 3-Well Unit	143 lbs.	22
NSG-15-4WELL*	4010	64 5/16" x 19 3/4" x 18 3/4"	GSG-15-4WELL*	4359	64 5/16" x 19 3/4" x 18"	Fits 4-Well Unit	186 lbs.	29
NSG-15-5WELL**	4380	79 5/8" x 19 3/4" x 18 3/4"	Not Available	Not Available	Not Available	Fits 5-Well Unit	215 lbs.	38
NSG-15-6WELL**	4380	94 15/16" x 19 3/4" x 18 3/4"	Not Available	Not Available	Not Available	Fits 6-Well Unit	247 lbs.	47

\*3/8" Thick Heat-Tempered Glass Required For Front Glass \*\*Requires a Single Center Post (Factory Print Included)

#### Cafeteria Style - Single Side

15" Wide Stainless Steel Shelf			Fits # of Bowls	Approx. Wt.	Approx. Cubes
Model #	Price	O.A. Size L x W x H			
NSGC-15-2WELL	\$3948	33 11/16" x 18" x 18 3/4"	Fits 2-Well Unit	135 lbs.	15
NSGC-15-3WELL	4065	49" x 18" x 18 3/4"	Fits 3-Well Unit	176 lbs.	22
NSGC-15-4WELL*	4453	64 5/16" x 18" x 18 3/4"	Fits 4-Well Unit	232 lbs.	29
NSGC-15-5WELL**	4738	78 5/8" x 18" x 18 3/4"	Fits 5-Well Unit	265 lbs.	38
NSGC-15-6WELL**	5300	94 15/16" x 18" x 18 3/4"	Fits 6-Well Unit	300 lbs.	47



NSGC-15-4WELL Shown

For Sleek Shield™ Modifications, Accessories  
and Heat Lamps, See Page 71

\*3/8" Thick Heat-Tempered Glass Required For Front Glass \*\*Requires a Single Center Post (Factory Print Included)

Due to mounting requirements, food shields extend 15/16" beyond the end of the hot or cold table on each end. Units set side by side must allow for this additional space.

#### Self-Serve - Double Sided

- 18 3/4" Standard Height (Top of Table To Top)
- 22 3/4" Wide Stainless Steel Shelf with Square Edges On All Four Sides.
- 1" Stainless Steel Tubing Posts
- Includes Two 16 3/8" High Glass Side Panels
- 1/4" Thick Heat-Tempered Glass Front & Sides
- Ships Set Up

25" Wide Stainless Steel Shelf			Fits # of Bowls	Approx. Wt.	Approx. Cubes
Model #	Price	O.A. Size L x W x H			
NSGD-26-2WELL	\$5604	33 1/16" x 32 1/4" x 18 3/4"	Fits 2-Well Unit	285 lbs.	20
NSGD-26-3WELL	5754	49" x 32 1/4" x 18 3/4"	Fits 3-Well Unit	340 lbs.	27
NSGD-26-4WELL*	6416	64 5/16" x 32 1/4" x 18 3/4"	Fits 4-Well Unit	425 lbs.	36
NSGD-26-5WELL**	6546	79 5/8" x 32 1/4" x 18 3/4"	Fits 5-Well Unit	515 lbs.	44



NSGD-26-4WELL Shown

\*3/8" Thick Heat-Tempered Glass Required For Front Glass \*\*Requires a Single Center Post (Factory Print Included)

Due to mounting requirements, food shields extend 15/16" beyond the end of the hot or cold table on each end. Units set side by side must allow for this additional space.

# ACCESSORIES

## Hot & Cold Table Accessories

### CAFETERIA SHELVES W/ BUILT-IN ACRYLIC FOOD SHIELDS

Features Removable Stainless Steel Shelf

#### Single Sided Cafeteria Style

- 15" High
- 1" Clearance From Table Top

Model	Price	Length	Approx Wt.	Cu. Ft.
TSS-2	\$1025	31-13/16"	17 lbs.	2
TSS-3	1166	47-1/8"	20 lbs.	3
TSS-4	1272	62-7/16"	23 lbs.	4
TSS-5	1367	77-3/4"	33 lbs.	4



#### Double Sided Self-Serve Style

- 19-3/4" High
- 10" Clearance From Table Top

Model	Price	Length	Approx Wt.	Cu. Ft.
TBS-2	\$1628	31-13/16"	28 lbs.	2
TBS-3	1679	47-1/8"	33 lbs.	3
TBS-4	1833	62-7/16"	38 lbs.	4
TBS-5	2099	77-3/4"	45 lbs.	4

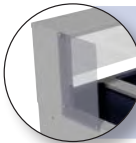

#### Acrylic Side Panel for TSS Series Shelves

Add Side Panels To Meet Additional NSF Requirements (1 Panel Per End) **TSP-1 \$259 One End**  
**TSP-2 \$518 Two Ends**

Field Installation Available

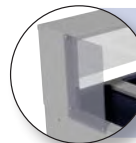

#### Acrylic Side Panel for TBS Series Shelves

Add Side Panels To Meet Additional NSF Requirements (2 Panels Per End) **TBP-1 \$311 One End**  
**TBP-2 \$623 Two Ends**

Field Installation Available

## LED Display Lighting

### For Everyday Buffets & Hot/Cold Table Shelving

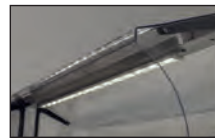

LED-B Series  
For Everyday Buffets



LED-H Series  
For Overshelves or Food Shields

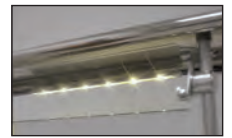

LED-G Series  
For GSG Series Food Shields

- Aluminum Rail with Shatter-Proof Optics
- Natural Aluminum Finish (Black or White Available On Request)
- Includes Class 2 Low Voltage Power Supply 120V-277V
- High Impact Resistant Mounting Clips

**NOTE:** Require 6" clearance on both sides to fit above LED Lighting. **PRINT REQUIRED FOR PROPER LED LOCATION. FACTORY INSTALLED ONLY**

Fits # of Wells	For use with Everyday Buffets		For use with STOS, TOS, TBS, TSS, NSG or NSGC Overshelves or Food Shields		For use with GSG Food Shields		LED Length
	Model #	Price	Model #	Price	Model #	Price	
2	LED-B-2	\$1415	LED-H-2	\$1415	LED-G-24	\$644	24"
3	LED-B-3	1659	LED-H-3	1659	LED-G-36	712	36"
4	LED-B-4	1906	LED-H-4	1906	LED-G-48	776	48"
5	LED-B-5	2182	LED-H-5	2181	Consult Factory		60"
6	Not Available		LED-H-6	2468	Consult Factory		72"

#### Individual Well Covers For Hot Food Tables

- Stainless Steel
- Removable
- Fits All Advance Tabco Hot Well Units

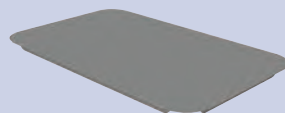

**HFC-1 \$342 Per Well**

#### Flip-Up Cover For Hot Food Tables

- Stainless Steel
- Removable
- Fits Advance Tabco Hot Well Units



Model #	Price	Fits # of Comp.	Wt.	Cu.
RC-1	\$711	1	23	5
RC-2	805	2	60	10
RC-3	928	3	74	15
RC-4*	1293	4	120	20
RC-5**	1441	5	134	25

\* Supplied with Two RC-2 Covers

\*\* Supplied with One RC-2 & One RC-3 Cover

#### Hinge Style Cover For Cold Food Tables

- Stainless Steel
- Plastic Handles & Piano Style Hinge(s)
- Fits CPU, DICP & MACP & BMAPC Units

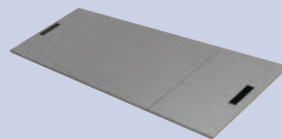

Model #	Price	Fits # of Comp.	Wt.	Cu.
HC-2	\$377	2	12	3
HC-3	564	3	16	4
HC-4	617	4	20	5
HC-5	717	5	24	6

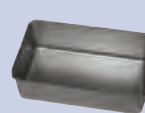

SP-A



TA-255P



SU-25S

#### Stainless Steel Legs & Undershelf Upgrade \$692

2 Well Table	3 Well Table	4 Well Table	5 Well Table
SU-23A	SU-23B	SU-23C	SU-23D

SU-6	Hot/Cold Food Table Handle	\$169 ea.
SU-25S	Add Casters to Food Units w/Undershelf (Includes 4 -5" Swivel Casters, 2 w/ Brakes)	394 Set of 4
SU-25	Add Casters to Food Units w/Undershelf (For Units Built Before October 2015. Includes 4 -5" Swivel Casters, 2 w/ Brakes.)	394 Set of 4
SU-19	Connect Cafeteria Items (One Charge For Each Table To Be Interlocked)	539 per table
TA-25	Replacement Casters For Undershelf Units (For Units Built after October 2015. Includes 4 -5" Swivel Casters, 2 w/ Brakes.)	394 Set of 4
TA-255P	Add Casters to Enclosed Base Food Units (Includes 4 -5" Bolted Swivel Casters, 2 w/ Brakes)	636 Set of 4
SU-32G	Upgrade to a Stainless Steel Lining (For Gas Units. Excludes Wetbath Units)	121 per well
SP-A	Aluminum Spillage Pan	125 ea.
SP-S	Stainless Steel Spillage Pan	219 ea.
TCB-OMIT	Remove Poly Cutting Board & Shelf	-200 ea.
CB-OMIT	Remove Poly Cutting Board	-100 ea.

# REPLACEMENT PARTS

## Replacement Parts For Hot Food Tables

 All Items on This Page Ship via UPS

### FOR GAS HOT FOOD TABLES



#### Gas Valve

Hi/Med/Lo

SU-P-101 \$76



#### Valve Adapter

SU-P-104 \$45



#### Gas Pilot Valve

SU-P-108 \$56



#### Gas Regulator

SU-P-109 \$104



#### Jet Burners

SU-P-105 \$117

NAT 5/16 #61

SU-P-106 \$117

LP 5/16 #74



#### Gas Pilot

For Wet Bath Units

SU-P-107 \$182

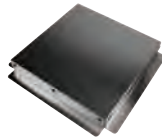

#### Gas Deflector

SU-P-411 \$32

Standard HFxG Units

SU-P-412 \$47

Stainless For SU-32G Wells



#### Pilot Assembly

HF-xG

SU-P-102 \$86



#### Gas Infinite Control Knob

SU-P-202 \$43



#### 1 1/2" Drain

Stainless Steel

For Wetbath Tables

SU-P-103 \$61



**new**

#### Strainer Screen

For Sealed Well Tables

SU-P-403 \$19

### FOR ELECTRIC HOT FOOD TABLES

#### ELECTRIC HEATING ELEMENTS

##### For Exposed Element (Dry) Models



SU-P-207 \$117

500W 120V

SU-P-204 \$117

1000W 240V

##### For Concealed Element Sealed Well (Wet) Models

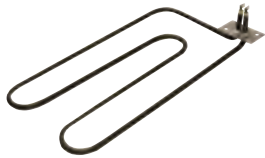

SU-P-209 \$134

640W 120V

SU-P-206 \$134

1100W 240V

SU-P-210 \$134

1100W 120V - For Drop-In Units Only

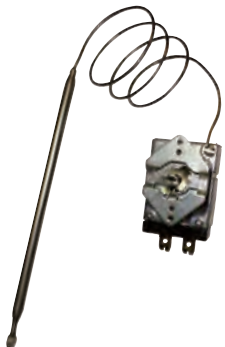

#### Thermostatic Control

#### Replacement Thermostatic Control

SU-P-220A \$213 Per Well

120v/240v, 24" lead For Free-Standing Sealed Well Hot Food Units

SU-P-220B \$213 Per Well

120v/240v, 24" lead For Drop-In Sealed Well Hot Food Units



#### Electric Infinite Control Knob

SU-P-201 \$43



#### Thermostatic Knob

(For Units with Thermostatic Control)

SU-P-219 \$46



#### Infinite Control

SU-P-205 \$103

120V

SU-P-215 \$103

240V



#### Indicator Lights

SU-P-216 \$74

120V

SU-P-217 \$74

240V



#### High Limit Switch Assembly

SU-P-208 \$158

250F

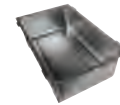

#### Replacement Sealed Well Sub-Assembly

SU-P-401 \$726

Without Element or High Limit Switch



SU-P-402 \$42

Sealed Well or Element Pan Only

#### NEMA Plugs

6' Cord Set



SU-P-230 \$98

NEMA 5-20P



SU-P-231 \$273

NEMA L5-30P



SU-P-232 \$98

NEMA 6-20P



SU-P-233 \$273

NEMA L6-30P



SU-P-234 \$152

NEMA 5-15

# ALUMINUM RACKS

## Aluminum Pan Racks



**FRONT LOAD**

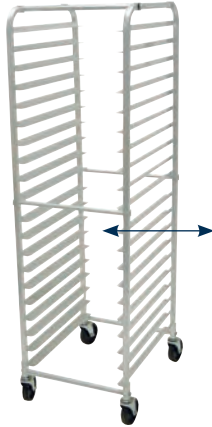

**SIDE LOAD**

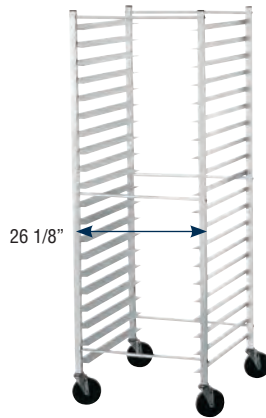

### K.D. PAN RACKS

- 6 Cylindrical Support Bars
- 1" Square Tubing
- 5" Poly Stem Bolted Casters
- 1 1/2" Ribbed Angles
- Shipped K.D.
- Easy To Assemble

Model #	Price	Description	Pan Capacity	Shelf Spacing	Overall Size	Approx. Wt.
<a href="#">PR10-3K</a>	<b>\$579</b>	Front Load	10 Full or 20 Half Size	3"	20 1/4" x 26" x 38 1/4"	14 lbs.
<a href="#">PR12-5K</a>	<b>609</b>	Front Load	12 Full or 24 Half Size	5"	20 1/4" x 26" x 69 1/4"	24 lbs.
<a href="#">PR18-3K</a>	<b>727</b>	Front Load	18 Full or 36 Half Size	3"	20 1/4" x 26" x 63 1/4"	31 lbs.
<a href="#">PR20-3K</a>	<b>687</b>	Front Load	20 Full or 40 Half Size	3"	20 1/4" x 26" x 69 1/4"	33 lbs.
<a href="#">PR30-2K</a>	<b>737</b>	Front Load	30 Full Size	2"	20 1/4" x 26" x 69 1/4"	39 lbs.
<a href="#">PR18-3KS</a>	<b>683</b>	Side Load	18 Full Size	3"	28 1/4" x 18" x 63 1/4"	31 lbs.
<a href="#">PR20-3KS</a>	<b>717</b>	Side Load	20 Full Size	3"	28 1/4" x 18" x 69 1/4"	27 lbs.

SEE PAGE 144  
FOR  
PROPER  
REPLACEMENT  
CASTERS



### ALL WELDED - CURVED TOP - STANDARD

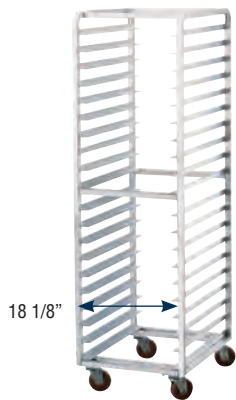

**SIDE LOAD**



**FRONT LOAD**

- Heavy Duty Welded Construction
- 1" Square Tubing
- Curved Top
- 5" Poly Stem Bolted Casters
- 6 Cross Supports
- 1 1/2" Heavy Duty Ribbed Angles

Model #	Price	Description	Pan Capacity	Shelf Spacing	Overall Size	Approx. Wt.
<a href="#">PR10-3W</a>	<b>\$671</b>	Front Load	10 Full or 20 Half Size	3"	20 1/4" x 26" x 38 1/2"	25 lbs.
<a href="#">PR10-6W</a>	<b>792</b>	Front Load	10 Full or 20 Half Size	6"	20 1/4" x 26" x 69 1/4"	27 lbs.
<a href="#">PR12-5W</a>	<b>807</b>	Front Load	12 Full or 24 Half Size	5"	20 1/4" x 26" x 69 1/4"	28 lbs.
<a href="#">PR15-4W</a>	<b>817</b>	Front Load	15 Full or 30 Half Size	4"	20 1/4" x 26" x 69 1/4"	31 lbs.
<a href="#">PR18-3W</a>	<b>830</b>	Front Load	18 Full or 36 Half Size	3"	20 1/4" x 26" x 63 1/4"	34 lbs.
<a href="#">PR20-3W</a>	<b>840</b>	Front Load	20 Full or 40 Half Size	3"	20 1/4" x 26" x 69 1/4"	35 lbs.
<a href="#">PR30-2W</a>	<b>985</b>	Front Load	30 Full or 60 Half Size	2"	20 1/4" x 26" x 69 1/4"	43 lbs.
<a href="#">PR10-6WS</a>	<b>899</b>	Side Load	10 Full Size	6"	28 1/4" x 18" x 69 1/4"	26 lbs.
<a href="#">PR12-5WS</a>	<b>910</b>	Side Load	12 Full Size	5"	28 1/4" x 18" x 69 1/4"	27 lbs.
<a href="#">PR15-4WS</a>	<b>1007</b>	Side Load	15 Full Size	4"	28 1/4" x 18" x 69 1/4"	30 lbs.
<a href="#">PR18-3WS</a>	<b>1031</b>	Side Load	18 Full Size	3"	28 1/4" x 18" x 63 1/4"	27 lbs.
<a href="#">PR20-3WS</a>	<b>1041</b>	Side Load	20 Full Size	3"	28 1/4" x 18" x 69 1/4"	34 lbs.

# ALUMINUM RACKS

## Specialty Racks

### ENCLOSED PAN CABINETS

- 14 Ga. Aluminum, Heavy Duty Welded Construction
- Enclosed Extrusions
- 5" Poly Plate Casters, 2 With Brakes
- Flip Style Door Latch Handle
- Side Door Lock to Prevent Opened Door From Swinging
- 37 Pan Capacity
- Optional Bumpers Available
- Optional Pull Handle For Improved Mobility.
- Does Not Interfere With Other Side By Side Units.



Model #	Price	Description	Pan Capacity	Shelf Spacing	Overall Size	Approx. Wt.
EPC-40	\$2310	Front Load	37 Full or 74 Half Size	1 1/2"	20 1/2" x 27 1/2" x 66 1/4"	110 lbs.

### Optional Accessories

Model #	Description	Price
RA-21	Optional Pull Handle .....	\$333
RA-22	Full Perimeter Bumpers .....	233
RA-23	Corner Bumpers .....	186

### FULL & HALF SIZE CAN RACKS

Aluminum Top   Poly Top   Stainless Steel Top



Half Can Racks



Full Can Rack



Full Can Rack With Casters

### SPEC-LINE



- Heavy Duty Welded Construction
- Metal Bullet Feet on CR10-162 only
- 4" Plate Casters with two Brakes. Standard on all Can Racks EXCEPT CR10-162 (See CR10-162M).

Model #	Price	Description	Can Capacity		Overall Size	Approx. Wt.
			#10	#5		
CR10-162	\$1514	Full Can Rack	162	216	24 3/4" x 35 1/8" x 71"	65 lbs.
CR10-162M	1948	Full Can Rack (with Casters)	162	216	24 3/4" x 35 1/8" x 71"	76 lbs.
CR10-72	1526	Aluminum Top	72	96	24 3/4" x 35 1/8" x 40 1/8"	59 lbs.
CR10-54	1255	Aluminum Top	54	72	24 3/4" x 35 1/8" x 32 5/8"	54 lbs.
CRPL10-72	1683	Poly Top	72	96	24 3/4" x 35 1/8" x 40 1/8"	79 lbs.
CRPL10-54	1462	Poly Top	54	72	24 3/4" x 35 1/8" x 32 5/8"	74 lbs.
CRSS10-72	1605	Stainless Steel Top	72	96	24 3/4" x 35 1/8" x 40 1/8"	63 lbs.
CRSS10-54	1584	Stainless Steel Top	54	72	24 3/4" x 35 1/8" x 32 5/8"	55 lbs.

# ALUMINUM RACKS

## Aluminum Pan Racks

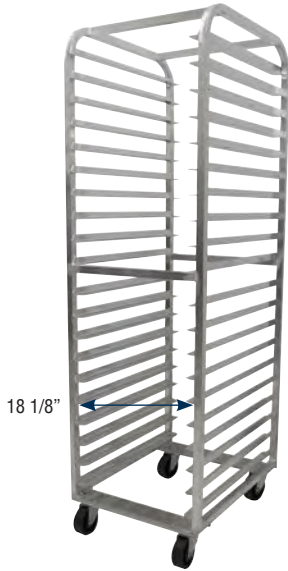

Front Load

### SPEC-LINE OVEN RACKS

Featuring High Temp Oven Plate Casters  
and All Welded Curved Top



- Heavy Duty Welded Construction
- 1" Square Tubing
- Curved Top
- 6 Cross Supports
- 4" Oven Plate Casters
- 1 1/2" Ribbed Angles

Model #	Price	Description	Pan Capacity	Shelf Spacing	Overall Size	Approx. Wt.
<b>CFL10</b>	<b>\$812</b>	Front Load	10 Full or 20 Half Size	6"	20 1/4" x 26" x 68 5/8"	37 lbs.
<b>CFL20</b>	<b>1033</b>	Front Load	20 Full or 40 Half Size	3"	20 1/4" x 26" x 68 5/8"	45 lbs.
<b>CFL30</b>	<b>1078</b>	Front Load	30 Full or 60 Half Size	2"	20 1/4" x 26" x 68 5/8"	53 lbs.

### Optional Accessories



Model #	Description	Price
<b>RA-10</b>	Pan Stop .....	<b>\$126</b>
<b>RA-20</b>	Track Pin.....	<b>106</b>
<b>ORL-B</b>	Oven Lift .....	<b>159</b>

(For Front Load Pan Racks)

### REACH-IN RACKS

- All Welded Construction
- 1" Square Tubing
- Holds up to 16 Full or 32 Half Size Pans
- 3" Shelf Spacing
- 1" Front and Rear Cross Bracing
- Shipped KD

Model #	Price	Pan Capacity	Shelf Spacing	Approx. Wt.
<b>RR-16</b>	<b>\$605</b>	16 Full or 32 Half Size	3"	23 lbs.



### BUS BOX RACK

- Heavy Duty Welded Construction
- Curved Top
- 5" Stem Bolted Casters
- Overall Size: 20 3/8" x 19" x 40 7/8"



Model #	Price	Bus Box Capacity	Approx. Wt.
<b>BC3</b>	<b>\$547</b>	3	18 lbs.

Consult Factory For All Welded Reach-In Racks

### KEG RACKS

- 76" High, Aluminum Alloy Construction
- Shelves Are 1-3/4" Square Tubing
- 60 Lbs. Per Sq. Ft. Load Capacity Per Shelf
- Center Support Included On 93" Keg Shelves



Model #	Price	Size	# of Kegs (Per Unit)	Approx. Wt.
<b>KR-42</b>	<b>\$1242</b>	20" x 42"	4	50 lbs.
<b>KR-60</b>	<b>1323</b>	20" x 60"	6	68 lbs.
<b>KR-72</b>	<b>1398</b>	20" x 72"	8	80 lbs.
<b>KR-80</b>	<b>1454</b>	20" x 80"	8	88 lbs.
<b>KR-93</b>	<b>1799</b>	20" x 93"	10	100 lbs.



### Keg Rack Rear Strap

Prevents Kegs From Sliding Off Rear Of Keg Rack Shelf

Model #	Price	Approx. Wt.
<b>KR-1-42</b>	<b>\$146</b>	6 lbs.
<b>KR-1-60</b>	<b>161</b>	7 lbs.
<b>KR-1-72</b>	<b>163</b>	8 lbs.
<b>KR-1-80</b>	<b>180</b>	9 lbs.
<b>KR-1-93</b>	<b>197</b>	10 lbs.

# SPECIALTY RACKS

## Specialty Racks

### PIZZA PAN & DOUGH RACKS

#### Pizza Pan Rack



- All Welded Construction
- Solid Aluminum Top
- 12 Pan Capacity
- Holds Both Round And Square Pizza Pans
- 2" Shelf Spacing
- 5" Poly Stem Bolted Casters
- 4" Wide Slides

19 5/8"

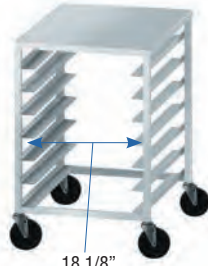

18 1/8"

#### PDB7

- All Welded Construction
- Solid Aluminum Top
- 7 Box Capacity
- 3 3/4" Shelf Spacing
- 5" Poly Stem Bolted Casters
- 2" Wide Slides

#### Pizza Dough Box Racks

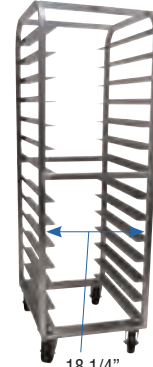

18 1/4"

#### PDB14

- All Welded Construction
- No Top
- 14 Box Capacity
- 3 3/4" Shelf Spacing
- 4" Plate Casters
- 2" Wide Slides

Model #	Price	Description	Overall Size	Approx. Wt.
<b>PZ12</b>	<b>\$1065</b>	Pizza Pan Rack	22" x 20" x 33 3/4"	52 lbs.
<b>PDB7</b>	<b>1133</b>	Pizza Dough Box Rack	26" x 20 1/4" x 33 3/4"	33 lbs.
<b>PDB14</b>	<b>1876</b>	Pizza Dough Box Rack (No Top)	26" x 20 1/4" x 61 1/2"	63 lbs.

### HALF SIZE RACKS



PR10-3WT Shown

- All Welded Construction
- 5" Poly Stem Bolted Casters
- 1-1/2" Ribbed Angles

#### PR7-4KT SERIES

- Removable Aluminum Top

PR7-4KT Shown



Model #	Price	Top	Description	Pan Capacity	Shelf Spacing	Overall Size	Approx. Wt.
<b>PR7-4KT</b>	<b>\$734</b>	Aluminum Top	Front Load	7 Full/14 Half Size	3 3/4"	20 5/8" x 26 7/8 x 36"	28 lbs.
<b>PR10-3WT</b>	<b>883</b>	Aluminum Top	Front Load	10 Full/20 Half Size	3"	20 1/4" x 26" x 38 1/2"	30 lbs.
<b>PR10-3PT</b>	<b>1103</b>	Poly Top	Front Load	10 Full/20 Half Size	3"	20 1/4" x 26" x 39"	45 lbs.
<b>PR10-3ST</b>	<b>1331</b>	Stainless Steel Top	Front Load	10 Full/20 Half Size	3"	20 1/4" x 26" x 39"	35 lbs.

\*Top shelf spacing on the PR7-4KT is 2-1/8"

### SPECIAL PURPOSE RACKS

#### Nesting Pan Rack

##### SPACESAVING DESIGN

18 1/4"

- Nested Design To Facilitate Maximum Storage In Minimum Space
- Heavy Duty Welded Construction With "Diagonal" Cross Supports
- 1 1/4" Square Tubing
- 1" X 1-1/2" Ribbed Angles
- Heavy Duty Stem Casters
- 500 Lb. Capacity

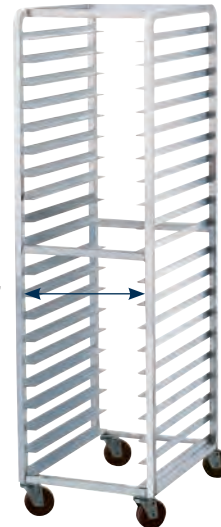

14 1/2"

#### Steam Table Pan Rack

- Heavy Duty Welded Construction
- 1" Square Tubing
- Curved Top
- 6 Cross Supports
- 5" Poly Stem Bolted Casters



Model #	Price	Pan Capacity	Shelf Spacing	Overall Size	Approx. Wt.
<b>NR-12</b>	<b>\$1022</b>	12 Full or 24 Half Size	5"	21" x 26" x 69 1/4"	28 lbs.
<b>NR-20</b>	<b>\$1250</b>	20 Full or 40 Half Size	3"	21" x 26" x 69 1/4"	29 lbs.

Model #	Price	Pan Capacity	Shelf Spacing	Overall Size	Approx. Wt.
<b>STR20-3W</b>	<b>\$1133</b>	20 Full or 40 Half Size	3"	16 3/4" x 21 1/4" x 69 1/4"	34 lbs.



# ALUMINUM RACKS

## Aluminum Racks

### PLATTER RACK

- Heavy Duty Welded Construction
- 1" Square Tubing
- Curved Top
- 5" Poly Stem Bolted Casters
- 1 1/2" Ribbed Angles

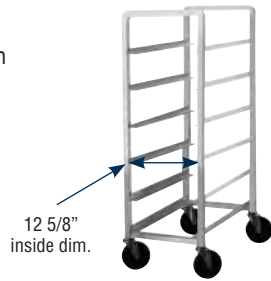

Model #	Price	Platter Capacity	Platter Size	Overall Size L x W x H	Approx. Wt.
PL6-12	\$866	6	12 1/2"	14 7/8" x 30" x 38 1/2"	21 lbs.

### LUG CARTS

- Heavy Duty Welded Construction
- 1" Square Tubing
- Curved Top
- 5" Stem Bolted Casters



Model #	Price	Lug Capacity	Overall Size L x W x H	Approx. Wt.
LR1	\$592	1	15 3/4" x 23 1/2" x 18 3/4"	15 lbs.
LR2	611	2	19" x 26" x 31 3/4"	18 lbs.
LR4	620	4	19" x 26" x 52 3/4"	21 lbs.
LR6	659	6	19" x 26" x 69 3/4"	23 lbs.

### UNIVERSAL RACKS

- Heavy Duty Welded Construction
- 1-1/4" Square Tubing
- 6 Cross Supports
- Heavy Duty 5" Stem Bolted Casters
- Stepped Angles
- Overall Size: 26" x 26" x 69 1/4"
- Front Tray Load

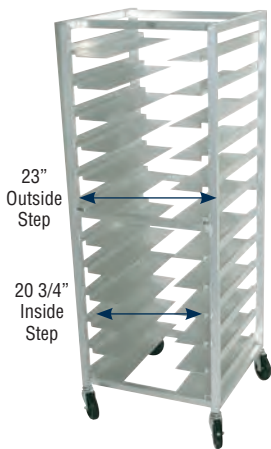

Model #	Price	Pan Capacity	Shelf Spacing	Approx. Wt.
UR10	\$1462	10 Full or 20 Half Size	6"	86 lbs.
UR12	1584	12 Full or 24 Half Size	5"	100 lbs.

### TRAY RACKS

Holds Baking Pans, Steam Table Pans & Service Trays

- Heavy Duty Welded Construction
- 1-1/4" Square Tubing
- Heavy Duty 5" Poly Stem Bolted Casters
- 4" Wide Angles
- Overall Size: 26" x 28" x 69 1/4"
- Front Tray Load

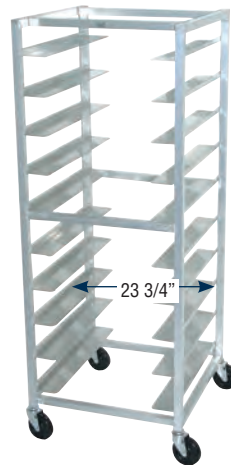

Model #	Price	Pan Capacity	Shelf Spacing	Approx. Wt.
OT10-6	\$1099	10 Full or 20 Half Size	6"	68 lbs.
OT20-3	1537	20 Full or 40 Half Size	3"	102 lbs.

### DONUT RACK

- Heavy Duty Welded Construction
- 1" Square Tubing
- Curved Top
- 6 Cross Supports
- 5" Poly Stem Bolted Casters
- Holds 23" x 23" and 24" x 24" Donut Screens
- Overall Size: 26 3/8" x 24" x 69 1/4"
- Front Tray Load

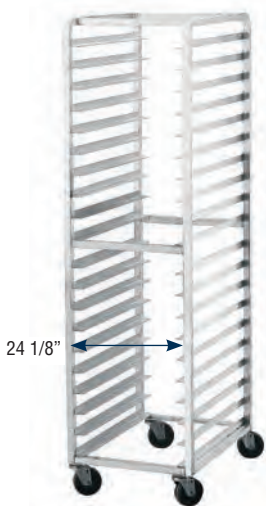

Model #	Price	Pan Capacity	Shelf Spacing	Approx. Wt.
DR20-3	\$852	20 Full or 40 Half Size	3"	39 lbs.

### WIRE PAN RACKS

- Heavy Duty Welded Frame Construction
- Curved Top
- 36 Full Size Pan Capacity
- 1 1/2" Shelf Spacing
- 6 Cross Supports
- 5" Stem Bolted Casters
- Nickel Chrome Plated Steel Wire Racks

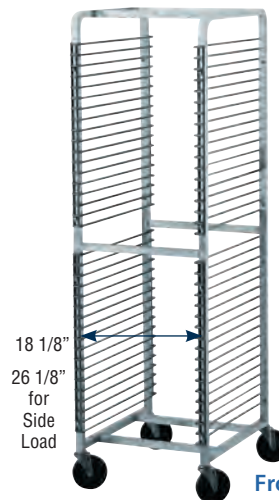

Front Load Shown



Model #	Price	Tray Load	Pan Capacity	Overall Size	Approx. Wt.
WR-36	\$1041	Front	36 Full or 72 Half Size	20 1/4" x 25" x 70 1/4"	72 lbs.
WR-36S	1107	Side	36 Full Size	28 1/4" x 19 1/8" x 70 1/4"	64 lbs.

# BUN PANS

## Bun Pans & Accessories



Look For Our Advertisized  
Specials on Sheet  
Pan Pricing

## ALUMINUM BUN PANS

 = All Bun Pans Ship via UPS

Model #	Price	Size	Style	Gauge	Approx. Wt.
<b>18-A-26</b>	<b>\$38 ea.</b>	18" x 26"	Heavy Duty	16	48 lbs.
<b>18-8A-26</b>	<b>33 ea.</b>	18" x 26"	Standard	18	40 lbs.
<b>18-8P-26</b>	<b>44 ea.</b>	18" x 26"	Perforated	18	33 lbs.
<b>18-8A-13</b>	<b>28 ea.</b>	18" x 13"	Half Size	18	24 lbs.

**Packed One Dozen per Carton.**  
**No splitting of CARTONS permitted.**

## PAN RACK ACCESSORIES

All Pan Rack Accessories Ship via UPS



12" Tall  
Vertical  
Bumper

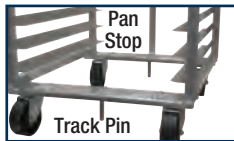

Pan  
Stop

Track Pin



Oven Lift for Front Load  
Pan Rack



Stem Bolted  
Caster



Hi-temp  
Oven  
Plate  
Caster



Plate  
Caster



Bun Pan  
Dolly  
Caster



PRC-1



PRC-2

### Bun Pan Rack Covers with 3 Zippers

**PRC-1** Enclosed Heavy Duty Plastic Cover.....**\$297 ea.**  
with Clear Front

**PRC-2** Economy See-Thru Plastic Cover..... **219 ea.**

**For Full Line of Aluminum Pan Racks,  
See Page 139-143**

Model #	Description	Weight Capacity	Approx. Weight	Price
<b>RA-10</b>	Pan Stop	-	3 lbs.	<b>\$126</b>
<b>RA-20</b>	Track Pin	-	3 lbs.	<b>106</b>
<b>RA-24</b>	12" Vertical Bumpers (Set of 4)	-		<b>145</b>
<b>RA-25</b>	5" Stem Bolted Caster	125 lbs.	4 lbs.	<b>53 ea.</b>
<b>RA-26</b>	5" Stem Bolted Caster w/ Brake	125 lbs.	4 lbs.	<b>63 ea.</b>
<b>RA-25SV</b>	5" Stem Bolted Caster for PR1803K, PR20-3K   & PR12-5K ONLY	125 lbs.	4 lbs.	<b>53 ea.</b>
<b>RA-26SV</b>	5" Stem Bolted Caster w/Brake for PR1803K, PR20-3K & PR12-5K ONLY	125 lbs.	4 lbs.	<b>63 ea.</b>
<b>RA-30</b>	4" Plate Caster w/ Built-in Zerk Grease Fitting	400 lbs.	4 lbs.	<b>180 ea.</b>
<b>RA-35</b>	4" Plate Caster w/ Brake	400 lbs.	4 lbs.	<b>189 ea.</b>
<b>RA-40</b>	4" Hi-temp Oven Plate Casters w/ Built-in Zerk Grease Fitting	300 lbs.	4 lbs.	<b>129 ea.</b>
<b>RA-45</b>	4" Hi-Temp Oven Plate Caster w/ Brake	300 lbs.	4 lbs.	<b>140 ea.</b>
<b>RA-50</b>	3" Bun Pan Dolly Caster	250 lbs.		<b>58 ea.</b>
<b>RA-60</b>	5" Heavy Duty Stem Caster for Universal & Oval Racks Only.	300 lbs.	4 lbs.	<b>84 ea.</b>
<b>RA-65</b>	5" Heavy Duty Stem Caster with Brake for Universal & Oval Racks Only.	300 lbs.	4 lbs.	<b>93 ea.</b>
<b>ORL-B</b>	18" Oven Lift For Front Load Pan Racks	-	1 lbs.	<b>159 ea.</b>

# RACKS & CARTS

Racks & Carts

## PAN TRUCK

- Heavy Duty Welded Construction
- 1" Square Tubing
- Curved Top
- Heavy Duty 3" Plate Casters
- Holds 60 Full Size Pans
- 600 lb. Weight Capacity



Model #	Price	Size	Approx. Wt.
PD-1	\$480	20" x 26 1/2" x 32"	20 lbs.

## UTILITY CARTS

- 2 Chrome Plated Numbered Posts
- 3 Adjustable Stainless Steel Shelves with Tapered Split Sleeves
- 4 Swivel Casters (2 w/Brakes) & Donut Bumpers
- 150 lb. Load Capacity
- Shipped Knocked Down



Model #	Price	Size	Shelf Size	Approx. Wt.
UC-3-1827	\$1357	31 3/4" x 18" x 38 1/4"	18" x 27"	25 lbs.
UC-3-2433	\$1771	37 3/4" x 24" x 38 1/4"	24" x 33"	40 lbs.

## GLASS RACK & PAN RACK DOLLIES

### Bun Pan Dolly



- Heavy Duty Welded Construction
- 3" Plate Casters
- Holds 60 Full Size Pans
- 600 lb. Weight Capacity



### Glass Rack Dolly

- Heavy Duty Welded Construction
- 3" Plate Casters
- 600 lb. Weight Capacity



Model #	Price	Description	Size	Approx. Wt.
 BPD-1	\$516	Bun Pan Dolly	26 3/4" x 18 3/4" x 5"	15 lbs.
 GRD-1	449	Glass Rack Dolly	20 1/2" x 20 1/2" x 5 1/4"	14 lbs.

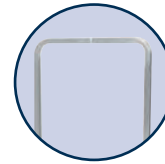

**Optional**  
Glass Rack Dolly Handle  
(Assembly Required)  
**RA-14 \$435**

## ALUMINUM DUNNAGE RACKS

### Stationary Dunnage Racks

8" & 12" Height Available



12" Height		8" Height		Size	# of Legs	Distribution Weight Capacity	Approx. Wt.
Model #	Price	Model #	Price				
DUN-2036	\$273	DUN-2036-8	\$273	20" x 36"	4	1500 lbs.	10 lbs.
DUN-2048	316	DUN-2048-8	316	20" x 48"	4	1800 lbs.	12 lbs.
DUN-2060	359	DUN-2060-8	359	20" x 60"	6	2000 lbs.	16 lbs.
DUN-2436	309	DUN-2436-8	309	24" x 36"	4	1500 lbs.	11 lbs.
DUN-2448	359	DUN-2448-8	359	24" x 48"	4	1800 lbs.	13 lbs.
DUN-2460	401	DUN-2460-8	401	24" x 60"	6	2000 lbs.	17 lbs.

### Mobile Dunnage Racks

- Four 6" Plate Casters (2 Swivel, 2 Stationary)
- Includes Pull Handle For Easier Mobility
- 2000 Lb. Rolling Capacity



**Now Includes Pull Handle**

### 36" Height with Handle

Model #	Price	Size	Distribution Weight Capacity	Approx. Wt.
DUN-2036C	\$729	20" x 36"	1500 lbs.	35 lbs.
DUN-2048C	804	20" x 48"	1800 lbs.	40 lbs.
DUN-2060C	936	20" x 60"	2000 lbs.	45 lbs.

# SHELVING

## Chrome & Green Epoxy Wire Shelving

All Items on This Page Ships via UPS

WIRE SHELVES **NSF**

Each Shelf Holds Up To 800 Lbs. Distributed Weight

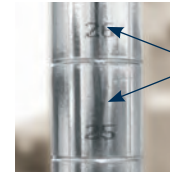
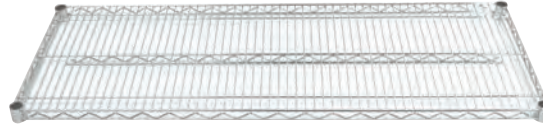

Posts are Numbered for easy assembly

	Shelf Size	CHROME	GREEN EPOXY	Price (Each)	Price (Set of 4)	Approx. Boxed Wt.	Approx. Boxed Cu. Ft.
<b>14" WIDE</b>	14" x 24"	<a href="#">EC-1424</a>	<a href="#">EG-1424</a>	\$61	\$244	35 lbs.	1.5
	14" x 30"	<a href="#">EC-1430</a>	<a href="#">EG-1430</a>	64	256	41 lbs.	2
	14" x 36"	<a href="#">EC-1436</a>	<a href="#">EG-1436</a>	68	272	47 lbs.	2.5
	14" x 42"	<a href="#">EC-1442</a>	<a href="#">EG-1442</a>	75	300	52 lbs.	3
	14" x 48"	<a href="#">EC-1448</a>	<a href="#">EG-1448</a>	83	332	58 lbs.	3.5
	14" x 60"	<a href="#">EC-1460</a>	<a href="#">EG-1460</a>	91	364	38 lbs.	2
	14" x 72"	<a href="#">EC-1472</a>	<a href="#">EG-1472</a>	123	492	45 lbs.	2.5
<b>18" WIDE</b>	18" x 24"	<a href="#">EC-1824</a>	<a href="#">EG-1824</a>	67	268	39 lbs.	2
	18" x 30"	<a href="#">EC-1830</a>	<a href="#">EG-1830</a>	69	276	45 lbs.	2.5
	18" x 36"	<a href="#">EC-1836</a>	<a href="#">EG-1836</a>	75	300	51 lbs.	3
	18" x 42"	<a href="#">EC-1842</a>	<a href="#">EG-1842</a>	88	352	56 lbs.	3.5
	18" x 48"	<a href="#">EC-1848</a>	<a href="#">EG-1848</a>	91	364	64 lbs.	4
	18" x 54"	<a href="#">EC-1854</a>	<a href="#">EG-1854</a>	116	464	35 lbs.	2
	18" x 60"	<a href="#">EC-1860</a>	<a href="#">EG-1860</a>	120	480	41 lbs.	2.5
<b>21" WIDE</b>	21" x 24"	<a href="#">EC-2124</a>	<a href="#">EG-2124</a>	71	284	42 lbs.	2.5
	21" x 30"	<a href="#">EC-2130</a>	<a href="#">EG-2130</a>	83	332	49 lbs.	3
	21" x 36"	<a href="#">EC-2136</a>	<a href="#">EG-2136</a>	89	356	56 lbs.	3.5
	21" x 42"	<a href="#">EC-2142</a>	<a href="#">EG-2142</a>	105	420	62 lbs.	4
	21" x 48"	<a href="#">EC-2148</a>	<a href="#">EG-2148</a>	111	444	70 lbs.	4.5
	21" x 54"	<a href="#">EC-2154</a>	<a href="#">EG-2154</a>	121	484	39 lbs.	2.5
	21" x 60"	<a href="#">EC-2160</a>	<a href="#">EG-2160</a>	135	540	45 lbs.	3
<b>24" WIDE</b>	24" x 24"	<a href="#">EC-2424</a>	<a href="#">EG-2424</a>	82	328	44 lbs.	3
	24" x 30"	<a href="#">EC-2430</a>	<a href="#">EG-2430</a>	91	364	51 lbs.	3.5
	24" x 36"	<a href="#">EC-2436</a>	<a href="#">EG-2436</a>	102	408	58 lbs.	4
	24" x 42"	<a href="#">EC-2442</a>	<a href="#">EG-2442</a>	111	444	64 lbs.	5
	24" x 48"	<a href="#">EC-2448</a>	<a href="#">EG-2448</a>	120	480	72 lbs.	5.5
	24" x 54"	<a href="#">EC-2454</a>	<a href="#">EG-2454</a>	140	560	41 lbs.	3
	24" x 60"	<a href="#">EC-2460</a>	<a href="#">EG-2460</a>	147	588	47 lbs.	3.5
	24" x 72"	<a href="#">EC-2472</a>	<a href="#">EG-2472</a>	168	672	55 lbs.	4

24" To 48" Length Shelves Are Packed 4 To A Box And 54", 60" And 72" Shelves Are Packed 2 To A Box. 4 Pair Plastic Split Sleeves Are Included With Each Shelf.

### POSTS FOR WIRE SHELVING

Posts Are Numbered

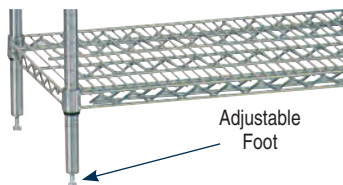

Post Height	Posts With Adjustable Foot				Posts For Casters <i>(Casters Priced Separately)</i>				Approx. Boxed Wt.	Approx. Boxed Cu. Ft.
	CHROME	GREEN EPOXY	Each	Set of 4	CHROME	GREEN EPOXY	Each	Set of 4		
14"	<a href="#">ECP-14</a>	<a href="#">EGP-14</a>	\$28	\$112	<a href="#">ECPC-14</a>	<a href="#">EGPC-14</a>	\$29	\$116	4 lbs.	.07
34"	<a href="#">ECP-34</a>	<a href="#">EGP-34</a>	36	144	<a href="#">ECPC-34</a>	<a href="#">EGPC-34</a>	36	144	8 lbs.	.18
54"	<a href="#">ECP-54</a>	<a href="#">EGP-54</a>	40	160	<a href="#">ECPC-54</a>	<a href="#">EGPC-54</a>	41	164	12 lbs.	.28
64"	<a href="#">ECP-64</a>	<a href="#">EGP-64</a>	44	176	<a href="#">ECPC-64</a>	<a href="#">EGPC-64</a>	47	188	15 lbs.	.33
74"	<a href="#">ECP-74</a>	<a href="#">EGP-74</a>	51	204	<a href="#">ECPC-74</a>	<a href="#">EGPC-74</a>	51	204	17 lbs.	.39
86"	<a href="#">ECP-86</a>	<a href="#">EGP-86</a>	61	244	<a href="#">ECPC-86</a>	<a href="#">EGPC-86</a>	61	244	20 lbs.	.45

### 5" CASTERS

Sets Feature 4 - 5" Swivel Casters (2 w/ Brakes & 4 Donut Bumpers)

Casters For Wire Shelving Only, See [Page 66](#) For Casters For Tables.

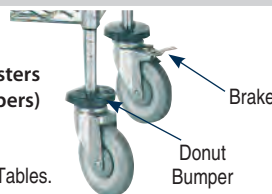

1000 lb. Max. Load Capacity For Shelving Casters

[EC-25](#) Rubber Casters.....\$269 /set of 4

[EC-26](#) Poly Casters..... 330 /set of 4

# SHELVING

## Shelving Combos

### CHROME & GREEN EPOXY WIRE SHELVING COMBOS

Includes 4 Wire Shelves And 4 - 74" Posts



Chrome



Green Epoxy

Chrome		Green Epoxy		Shelf Size	Post Height	Approx. Wt.
Model #	Price	Model #	Price			
ECC-1436	\$476	EGG-1436	\$476	14" x 36"	74"	64 lbs.
ECC-1442	504	EGG-1442	504	14" x 42"	74"	69 lbs.
ECC-1448	536	EGG-1448	536	14" x 48"	74"	75 lbs.
ECC-1460	568	EGG-1460	568	14" x 60"	74"	93 lbs.
ECC-1472	696	EGG-1472	696	14" x 72"	74"	107 lbs.
ECC-1836	504	EGG-1836	504	18" x 36"	74"	68 lbs.
ECC-1842	556	EGG-1842	556	18" x 42"	74"	73 lbs.
ECC-1848	568	EGG-1848	568	18" x 48"	74"	81 lbs.
ECC-1854	668	EGG-1854	668	18" x 54"	74"	88 lbs.
ECC-1860	684	EGG-1860	684	18" x 60"	74"	99 lbs.
ECC-1872	764	EGG-1872	764	18" x 72"	74"	115 lbs.
ECC-2436	612	EGG-2436	612	24" x 36"	74"	75 lbs.
ECC-2442	648	EGG-2442	648	24" x 42"	74"	81 lbs.
ECC-2448	684	EGG-2448	684	24" x 48"	74"	89 lbs.
ECC-2454	764	EGG-2454	764	24" x 54"	74"	97 lbs.
ECC-2460	792	EGG-2460	792	24" x 60"	74"	111 lbs.
ECC-2472	876	EGG-2472	876	24" x 72"	74"	127 lbs.

### MOBILE CARTS

Includes 4 Chrome Wire Shelves And 4 - 64" Posts

- 4 Swivel Casters (2 with Brakes & 4 Donut Bumpers)
- Finished Height of 70"
- Weight Capacity Not To Exceed 1000 lbs. Total Weight



w/ Rubber Casters		w/ Poly Casters		Shelf Size	Approx. Wt.
Model #	Price	Model #	Price		
MC-1836R	\$745	MC-1836P	\$806	18" x 36"	43 lbs.
MC-1848R	809	MC-1848P	870	18" x 48"	55 lbs.
MC-1860R	925	MC-1860P	986	18" x 60"	86 lbs.
MC-2436R	853	MC-2436P	914	24" x 36"	62 lbs.
MC-2448R	925	MC-2448P	986	24" x 48"	76 lbs.
MC-2460R	1033	MC-2460P	1094	24" x 60"	98 lbs.

FOR ADDITIONAL SHELVING, SEE PAGE 142

### WIRE UTILITY CARTS

- 3 Chrome Wire Shelves
- Tubular Numbered Handles
- 12 Plastic Split Sleeves
- 32" Finished Height
- 4 - Swivel Casters (2 w/ Brakes & Donut Bumpers)



Rubber Casters		Poly Casters		Size	Approx. Wt.	Approx. Cu. Ft.
Model #	Price	Model #	Price			
WUC-1836R	\$696	WUC-1836P	\$757	18" x 36"	53 lbs.	3
WUC-1842R	735	WUC-1842P	796	18" x 42"	55 lbs.	4
WUC-2436R	777	WUC-2436P	838	24" x 36"	58 lbs.	4
WUC-2442R	804	WUC-2442P	865	24" x 42"	61 lbs.	5

800 lb. Capacity      1000 lb. Capacity

### UTILITY CART HANDLES

34" Tubular Numbered Posts (Fits EC-25 And EC-26 Casters)

Model #	Price	Width
UCH-18	\$87 ea.	18"
UCH-24	101 ea.	24"



### SOLID STAINLESS STEEL SHELVES

Use With Chrome Posts Only (Posts Not Included)

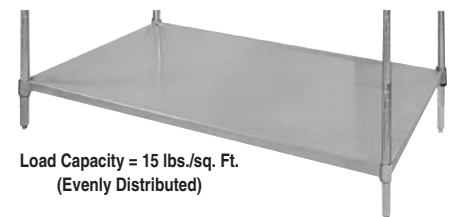

Load Capacity = 15 lbs./sq. Ft. (Evenly Distributed)

Model #	Price	Width
SH-1824	\$299 ea.	18" x 24"
SH-1836	375 ea.	18" x 36"
SH-1842	402 ea.	18" x 42"
SH-1848	448 ea.	18" x 48"
SH-1860	542 ea.	18" x 60"

# WIRE SHELVING

## Specialty Wire Shelving & Accessories

### WALL SHELF MOUNTING BRACKETS

Single Mount Includes 2 Brackets  
& 4 Collar Filler Caps

Double Mount Includes 1 Bracket

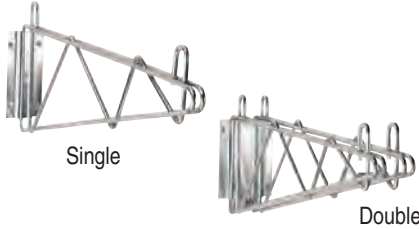

Chrome	Green Epoxy	Price	Size	Approx. Wt.
<b>SINGLE BRACKET</b>				
SB-14	GB-14	\$102	14"	2 lbs.
SB-18	GB-18	127	18"	3 lbs.
<b>DOUBLE BRACKET (For Adjoining Shelves)</b>				
DB-14	GDB-14	117	14"	3 lbs.
DB-18	GDB-18	152	18"	4 lbs.

### WALL MOUNTED SHELVING SYSTEM

Mounting Hardware Included • Shelves Sold Separately

#### End Mount Kit

- 4 Single Shelf Brackets
- 2 - 34" Posts
- Collar Filler Caps

**AB2-14 \$229**      **AB2-18 \$306**  
14" Wide              18" Wide

#### Mid-Mount Kit

- 2 Double Shelf Brackets
- 1 - 34" Posts
- For Adjoining Shelves

**ABM2-14 \$158**      **ABM2-18 \$188**  
14" Wide              18" Wide

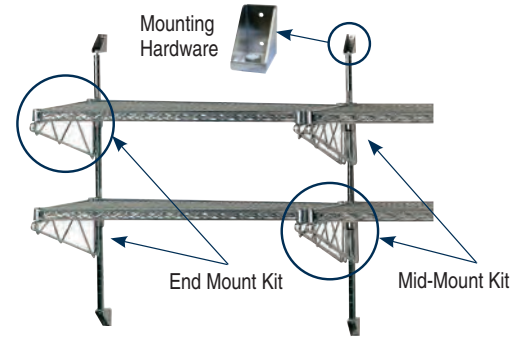

For Additional Tiers, Order Larger Posts On Page 140 With EC-50 Mounting Hardware For Each Post And Use The Following Brackets.

### WALL MOUNTED SHELVING SYSTEM EXPANSION KITS

- Includes Adjustable Bracket(s)

#### 2 Single End Mount Brackets

**AAB-14 \$63**  
14" Wide

**AAB-18 \$71**  
18" Wide

#### 1 Double Mid-Mount Bracket

**AABM-14 \$81**  
14" Wide

**AABM-18 \$92**  
18" Wide

#### Mounting Hardware

- Includes 2 End Mounts & 1 Mid-Mount Per Post

**EC-50 \$51**

## REPLACEMENT PARTS & ACCESSORIES



EC-10



EC-16



EC-20



EC-30



EC-15



EC-11



EC-5



EC-40

- EC-5** Post Clamp .....\$18 ea.
- EC-10** Replacement Leveling Foot .....12 ea.
- EC-11** Foot Plate ..... 17 ea.
- EC-15** Chrome Collar Filler Caps .....15 /pack  
(For Add-Shelving and Wall Mounted Shelves - 4 per pack)
- EC-16** Plastic Post Cap (4 pair per pack) ..... 13 /pack
- EC-20** Tapered Split Sleeves (4 per pack) ..... 15 /pack
- EC-30** S Hooks for add-shelving (2 pair per pack) ..... 24 /pack
- EC-40** Black Label Holder (3" x 1") ..... 24 ea.

### CASTERS FOR WIRE SHELVING

5" Swivel Stem Casters (2 w/ Brakes & 4 - Donut Bumpers)

Load Capacity Is 500 Lbs. Per Set.



#### Rubber

**EC-25 \$269**  
Set of 4



#### Poly

**EC-26 \$330**  
Set of 4

THESE CASTERS ARE FOR WIRE SHELVING UNITS ONLY.

See Page 62 For S/S Worktable Casters.

## ADVANCE TABCO WARRANTY

### General Terms for all Advance Tabco items (including those listed below):

- Warranty applies in the 48 contiguous United States only
  - ALL WARRANTY WORK MUST BE AUTHORIZED BY THE FACTORY BEFORE ANY WORK IS PERFORMED. Work performed without prior authorization shall be covered under this warranty only at the sole discretion of Advance Tabco
  - At no time will expenses to be paid under warranty exceed the original cost of the item
  - Routine maintenance and wear items are not covered by warranty.
  - Repair parts are sent by ground transportation. Any expedited freight charges will be at the expense of the end user
  - Warranty applies only under conditions of normal use and does not apply to defects which result from negligence, misuse, freight damage, improper installation or accidents.
  - Warranty does not include any coverage for loss of business, damages, freight or other miscellaneous expenses incurred due to the defect or in servicing the unit.
  - This warranty is made in lieu of all other warranties express or implied and no additional warranties express or implied, including one of merchantability or fitness for a particular purpose are given.
- If defects are the result of **freight or handling damage** your first recourse MUST be to notify the delivering freight carrier of the damage. If possible any damage should be noted on the delivery receipt at the time of delivery. Defects due to freight damage should be referred to the freight carrier for correction and compensation (this applies regardless of who was responsible for paying the freight charges or selecting the carrier).
- **Hot Food and Refrigerated Tables and Drop-Ins** are warranted for 12 months from the date of shipment from the factory or 6 months from the date first placed into service (whichever comes first) and include the following terms:
- Applies only to parts directly related to the electric, gas or refrigeration components of covered items (see below for all other parts)
  - Covers parts and labor during the warranty period (refrigeration components include labor coverage for 12 months from date of shipment or 3 months from date placed into service, with parts covered as described above). Labor performed after hours, as overtime, on weekends or on holidays is not covered by this warranty (end user may authorize and pay such expenses directly to service agency if desired)
  - Includes travel up to 100 miles round trip or 2 hours of travel time (additional travel will be at the end users expense)
- **Refrigeration Compressors for Tables and Drop-ins** are eligible for additional optional warranty coverage (if purchased):
- Must be purchased at the time the covered unit is ordered from the factory
  - Valid for 60 months from the date of shipment from the factory
  - Covers parts only (no labor, no freight). Applies only to the compressor unit
  - Excludes the cost of refrigerant
- **Refrigerated underbar equipment (Glass Frosters, Bottle Coolers, Back Bar Refrigeration)** is warranted for 24 months from the date of shipment from the factory and includes the following terms:
- Covers parts and labor during the warranty period. Labor performed after hours, as overtime, on weekends or on holidays is not covered by this warranty (end user may authorize and pay such expenses directly to service agency if desired)
  - Includes travel up to 100 miles round trip or 2 hours of travel time (additional travel will be at the end users expense)
  - Compressors only are warranted for a total of 60 months parts only (36 months parts after the initial 24 month parts and labor coverage)
- **Ware Washing Machines** are warranted for 12 months from the date of shipment from the factory and include the following terms:
- Covers parts and labor during the warranty period. Labor performed after hours, as overtime, on weekends or on holidays is not covered by this warranty
  - Includes travel up to 100 miles round trip or 2 hours of travel time (additional travel will be at the end users expense)
  - Any repairs or service conducted other than by an authorized service agent will void this warranty
- **All Advance Tabco items not mentioned above (including parts not otherwise covered for hot food and refrigerated units)** are warranted free of defects in workmanship and materials for 90 days from the date of shipment from the factory. Warranty includes parts only (no labor). At Advance Tabco's discretion we may repair or replace the defective item.

## TERMS & CONDITIONS

All previous prices and discounts are hereby withdrawn

- All prices are F.O.B. factory.
- All prices, specifications and discounts subject to change without notice. Prices listed herein do not include Federal Excise, Municipal or other use Tax.
- Orders that are shipped to an active construction site or residential address are subject to additional charges by the carrier. These charges may be applied after shipment.
- Not responsible for any damage while in hands of carrier. Inspect immediately for hidden damage. (For any damage and loss while in transit, promptly file claim against carrier.)
- Merchandise shipped open account to those firms furnishing satisfactory credit references. Terms are 1% Discount - 10 days; Net - 30 days.
- Quotations, unless otherwise stated, are for 60 day acceptance.
- Returns: A 30% handling charge will be applied to all authorized returns. **Minimum charge \$50.00. Equipment older than 6 months is not eligible for returns.**
- A 50% handling charge will be applied to all unauthorized returns.
- Orders for special items are not subject to cancellation without our written consent.
- Our consent must be obtained before defective merchandise is returned. Incoming freight or express charges may be collected and exchanged items will be shipped prepaid.
- On return shipments that we sanction, where orders have been correctly filled out and not defective, the incoming freight or express charges must be prepaid. Credit will then be issued, less a reasonable handling charge and less whatever expense is necessary to put goods in salable condition.
- We are not responsible for any delays in delivery which are beyond our control such as fires, strikes, delays in transportation or any contingencies of similar character.
- All orders subject to acceptance at our office.
- Possession of price list does not constitute an offer to sell.
- Minimum charge on all orders is \$50.00 NET.

## GENERAL SHIPPING INFORMATION

1. We reserve the right to ship via carriers that in our opinion are the most efficient. We will follow customers routing if possible.
2. Unless specified, all orders shipped freight collect.
3. All "Drop Shipments" will be shipped "Prepaid & Charge".
4. Shipper is not responsible for any unauthorized accessorial charges. All charges will be billed back to customer.

## PREPAID FREIGHT CHARGES

- Minimum UPS charge = \$20.00.
- Estimated freight charges added to an invoice will include a nominal administrative charge per freight bill.

## ESTIMATED SHIPPING WEIGHTS ARE TO SERVE AS A GUIDE ONLY!

- Weights are averaged for all models within a given classification. Actual shipping weights may vary from those shown. Correct weight will be shown on your Bill of Lading.



Leading National Fabricator

# THANK YOU

For recognizing us Best-In-Class 17 Years In-A-Row!

Work Tables - Sinks - Custom Stainless Steel Fabrication



Follow Us



[www.advancetabco.com](http://www.advancetabco.com) | [customer@advancetabco.com](mailto:customer@advancetabco.com) | Ph: 800-645-3166 | Fx: 631-242-6900  
Corporate Headquarters: 325 Wireless Boulevard | Hauppauge | NY | 11788

National Manufacturing: Georgia<sup>2</sup> | Tennessee | Texas<sup>2</sup> | Mississippi<sup>2</sup> | New York | Kentucky | South Carolina