



GAR[®]
PRODUCTS

Great conversations start here.™

2019



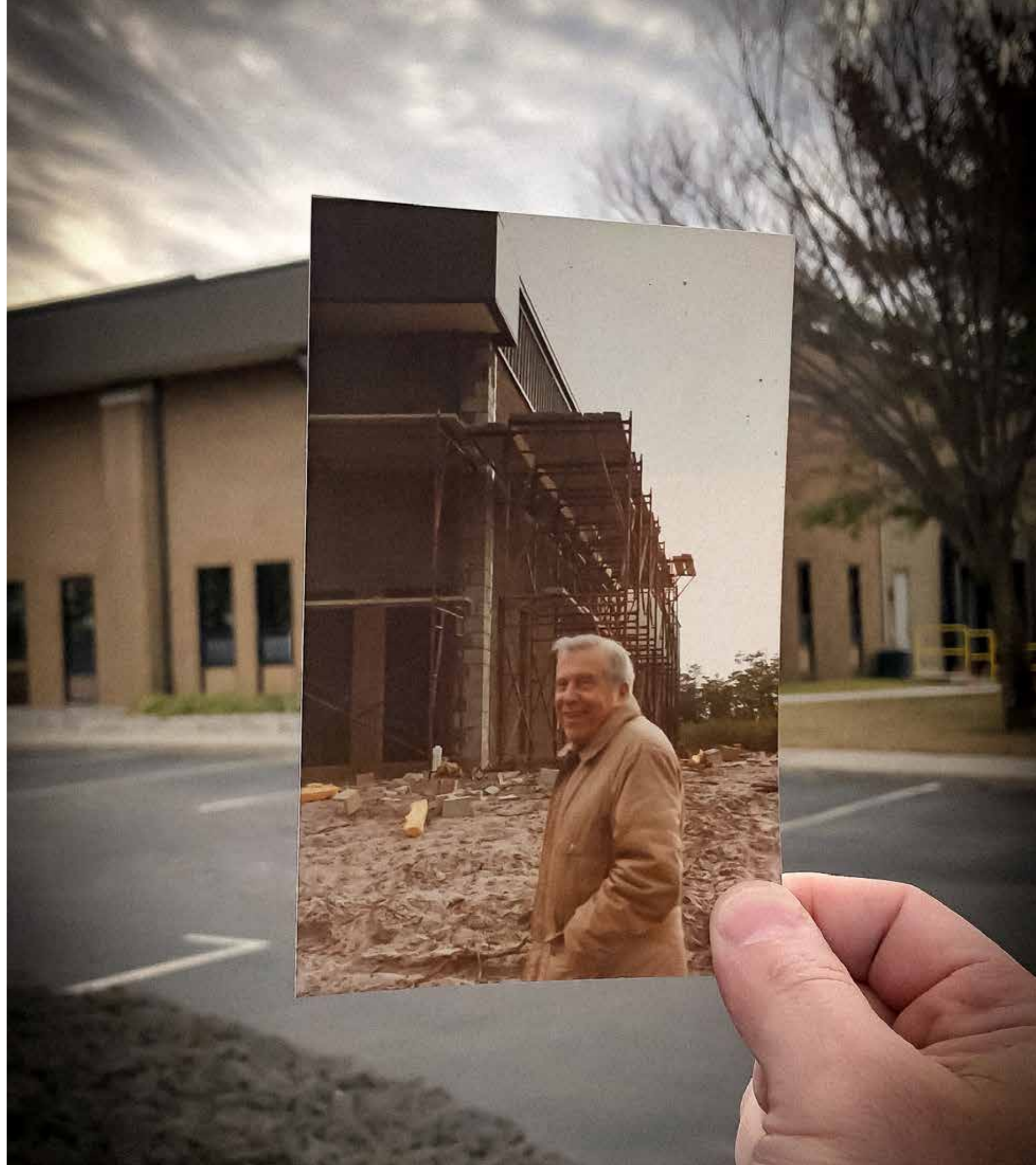

TIME HAS A WONDEFUL WAY OF SHOWING US WHAT REALLY MATTERS.

HONESTY. INTEGRITY. LOYALTY. QUALITY

From a small store front building on Central Avenue in Newark, New Jersey, the Garfunkle legacy was born. With little money, a tremendous amount of knowledge and the determination, Eleanor (known as Ellie) and Morris (fondly known to all as GAR), started their amazing journey.

Chair product by chair product, barstool element by barstool element; they were determined to seek out a living. Their product was built better. They were immensely loyal to the few clients they had always looking to secure their trust with honesty and integrity.

Let's fast forward to 2019. Here we are in Lakewood, NJ in a 102,000 sq. foot state of the art facility on the backs of their children, under the astute eye of their son and his wife, the legacy continues. We have never strayed from our core values of honesty, integrity, loyalty, and quality.

Start your journey into our continued legacy and always remember:

"GREAT CONVERSATIONS START HERE"

36

VERA SIDE CHAIR PSPB

Reintroducing a classic dining chair from a bygone era. The Vera is more than a look, it's a pleasure to sit on. The matching armchair and barstool offer stylish grace and comfort.



CONTENTS

INDOOR

16

INDOOR SEATING

From Classic GAR styles to our latest designs, there's the perfect selection to fit every aesthetic.



52

LOUNGE SEATING

Bold soft seating designs to compliment any interior.



38

FOUNDATION COLLECTION

Elegant yet versatile, the Foundation Collection offers a universal frame with countless possibilities.



58

INDOOR TEXTILES

A generous array of textures and colors to suit your project needs.



08	OUR COMMITMENT
10	WARRANTY
16	INDOOR SEATING
38	FOUNDATION COLLECTION
52	LOUNGE
58	INDOOR TEXTILES
74	TABLES x BASES
82	TABLE TOPS
90	DETAILS
94	FINISHES



106

BOLONIA ARMCHAIR BY ISIMAR x GAR

Our brand collaboration with iSiMAR brings smart European designs and the ease of Mediterranean life to our backyard.

CONTENTS

4 SEASONS

100

ISIMAR x GAR

Our brand alignment with iSiMAR brings smart European design and the ease of Mediterranean lifestyles to our outdoor installations

106

MEDITERRANEAN COLLECTION

Bold, eye-catching modern designs that are just as inviting indoors as they are outdoors.

116

SOUTH SEAS COLLECTION

A mixed-media of genuine teak, rope and steel

142

SPECIAL ORDER

Corresponding lounge and additional collections available in 28 vibrant colors.

- 100 ISIMAR x GAR
- 106 MEDITERRANEAN COLLECTION
- 116 SOUTH SEAS COLLECTION
- 128 TABLES x BASES
- 142 SPECIAL ORDER
- 170 OUTDOOR TEXTILES
- 176 CARE x MAINTENANCE

COMMITMENT

OUR PROMISE TO YOU

CORE VALUES

A lot has changed over the years, but the one thing that never will is our enduring commitment to delivering quality and value in each product that we manufacture.

QUALITY

According to the dictionary, "In business, engineering, and manufacturing, quality has a pragmatic interpretation as the non-inferiority or superiority of something. It is also defined as being suitable for its intended purpose while satisfying customers expectations." What a perfect description of our product line. We build in a reliable, maintainable and sustainable fashion.

AUTHENTICITY

With 63 years experience, GAR has learned to manufacture seating with a statement. Furniture with a flair for now without forgetting the past. Our statement for today.

HONESTY

Honesty permeates our relationships, processes, and products. As GAR always said, "Build with structural conviction and never compromise the truth"

INTEGRITY

Strong moral and uncompromising ethical principles and values. The word evolved from the latin adjective "Integer", meaning whole or complete. The value, beliefs, and principles of GAR best describe us as a leading manufacturer of commercial seating.

INNOVATION

New ideas, refreshed versions, daring to dream. We have created better solutions to deliver state of the art products. The ability to have a positive impact on the future of our marketplace. Our engineering mantra is "For every action, there is a reaction." Mr. GAR drilled that into our heads. We must build for the unknown. Unfortunately, our product may not be used for its intended purpose. We must over manufacture. We must over design. We must over engineer. Our innovations are dictated by our marketplace to meet the growing customer demand. It is definitely a catalyst for growth. Entrepreneurs continuously look for better ways to satisfy their customer with the first and foremost, improved quality, durability, service and price. GAR prides itself on advanced technologies and innovative organizational strategies.

Always remember,

"GREAT CONVERSATIONS START HERE"



WARRANTY PRODUCTS

INDOOR SEATING

GAR Products® warrants all standard indoor wood seating for a period of ten (10) years to be free from structural defects in frame material and craftsmanship under normal use and service, except for our Lounge series. Our Lounge series will be warranted for one (1) year. Any finish will be warranted for a period of one (1) year to be free from defects under normal use and service, except for genuine teak, faux teak and Thai teak. These finishes and/or slats require periodic maintenance therefore are not covered by our warranty. Any woven or rope material will be warranted for a period of one (1) year to be free from defects under normal use and service. This warranty does not include discontinued or closeout items. If there are exceptions to this warranty it will be noted on your order.

INDOOR TABLE BASES

GAR Products® warrants all standard indoor table bases for a period of ten (10) years to be free from structural defects in frame material and craftsmanship under normal use and service. Any finish will be warranted for a period of one (1) year to be free from defects under normal use and service. This warranty does not include discontinued or closeout items. If there are exceptions to this warranty it will be noted on your order.

INDOOR TABLETOPS

GAR Products® warrants all standard indoor tabletops for a period of one (1) year to be free from structural defects in material and craftsmanship under normal use and service. Any finish will be warranted for a period of one (1) year to be free from defects under normal use and service, except for genuine teak, faux teak and Thai teak. These finishes and/or slats require periodic maintenance therefore are not covered by our warranty. This warranty does not include discontinued or closeout items. If there are exceptions to this warranty it will be noted on your order.

4 SEASONS INDOOR/ OUTDOOR SEATING

GAR Products® warrants all 4 Seasons indoor/ outdoor seating for a period of three (3) years to be free from structural defects in frame material and craftsmanship under normal use and service. Any finish will be warranted for a period of one (1) year to be free from defects under normal use and service, except for genuine teak, faux teak and Thai teak. These finishes and/or slats require periodic maintenance therefore are not covered by our warranty. Any woven or rope material will be warranted for a period of one (1) year to be free from defects under normal use and service. Glides are not covered under any warranty. This warranty does not include discontinued or closeout items. If there are exceptions to this warranty it will be noted on your order.

4 SEASONS OUTDOOR TABLETOPS

GAR Products® warrants all outdoor tabletops for a period of one (1) year to be free from structural defects in material and craftsmanship under normal use and service. Any finish will be warranted for a period of one (1) year to be free from defects under normal use and service, except for genuine teak, faux teak and Thai teak. These finishes and/or slats require periodic maintenance therefore are not covered by our warranty. This warranty does not include discontinued or closeout items. If there are exceptions to this warranty it will be noted on your order.

CUSTOM PRODUCT

Custom order and/or designed product not otherwise identified explicitly in the product guide, is warranted for a period of one (1) year to be free from structural defects in frame material and craftsmanship under normal use and service. Any finish will be warranted for a period of one (1) year to be free from defects under normal use and service, except for genuine teak, faux teak and Thai teak. These finishes and/or slats require periodic maintenance therefore are not covered by our warranty. Any woven or rope material will be warranted for a period of one (1) year to be free from defects under normal use and service. Glides are not covered under any warranty. If there are exceptions to this warranty it will be noted on your order.

UPHOLSTERY

All indoor and outdoor upholstery materials are covered solely by the corresponding upholstery manufacturer's warranty. This warranty does not include discontinued or closeout items. If there are exceptions to this warranty it will be noted on your order.

ANY CLOSEOUT OR DISCONTINUED PRODUCT

GAR Products® warrants most closeout or discontinued item for a period of one (1) year to be free from structural defects in frame material and craftsmanship under normal use and service. Any finish will be warranted for a period of one (1) year to be free from defects under normal use and service, except for genuine teak, faux teak and Thai teak. These finishes and/or slats require periodic maintenance therefore are not covered by our warranty. Any woven or rope material will be warranted for a period of one (1) year to be free from defects under normal use and service. Glides are not covered under any warranty. If there are exceptions to this warranty it will be noted on your order.



THE SLEEK
CHAMFERED
DETAIL OF
THE JARL
SIDE CHAIR
STYLE.



HENRIK ARMCHAIR



HÄGEN ARMCHAIR





INDOOR SEATING

HANDSOME DESIGNS, REFINED DETAILS, AND THE MOST GENEROUS WARRANTY AROUND.

INDOOR

118 SERIES

FEATURES

LACQUER FINISHES: Black, Natural, Mahogany or Walnut

AVAILABLE WITH: Veneer Seat, Padded Seat, Padded Nail Seat, Padded Back, Padded Nail Back

OPTIONAL ADD-ONS: Underseat Counter Weight



118 VS SIDE



118 PS SIDE



118 PSPNB SIDE

LACQUER



PADDED NAIL SEAT



PADDED NAIL BACK

118 SIDE CHAIR

16¹/₄"W | 21³/₄"D | 34³/₄"H | 18³/₄"SH | 16¹/₄"SD

INDOOR

205 SERIES

FEATURES

LACQUER FINISHES: Black, Cherry, Honey Oak, Mahogany, Natural or Walnut

UV FINISHES: 15 Standard Finishes

AVAILABLE WITH: Saddle Seat, Veneer Seat, Padded Seat, Wrapped Sides, Padded Back, Padded Nail Back, Padded Outside Back



205 SS SIDE



205 PS SIDE



205 PSPOB BAR

UV

LACQUER



WRAPPED SIDES



PADDED NAIL BACK



PADDED BACK

205 SIDE CHAIR

17¹/₂"W | 20¹/₄"D | 34"H | 18"SH | 16¹/₄"SD

205 BARSTOOL

18¹/₄"W | 20¹/₄"D | 43³/₄"H | 30¹/₂"SH | 16¹/₄"SD

206 SERIES

INDOOR

FEATURES

LACQUER FINISHES: Black, Cherry, Mahogany or Walnut

UV FINISHES: 15 Standard Finishes

AVAILABLE WITH: Padded Seat, Padded Seat Wrapped Sides, Padded Back



206 PS BAR



206 PS SIDE

206 SIDE CHAIR

18³/₄"W | 18³/₄"D | 33¹/₄"H | 18"SH | 16¹/₄"SD

206 BARSTOOL

18³/₄"W | 19¹/₄"D | 43¹/₂"H | 30¹/₂"SH | 16¹/₄"SD



PADDED SEAT WRAPPED SIDES



PADDED BACK

LACQUER
UV

210 SERIES

INDOOR

FEATURES

UV FINISHES: 15 Standard Finishes

AVAILABLE WITH: Padded Seat Overupholstered Back, Padded Seat Wrapped Sides Overupholstered Back, Padded Seat Two Piece Back, Padded Seat Wrapped Sides Two Piece Back

Note: Garhyde and Symphony Vintage vinyls cannot be used for upholstery



210 PSWSOUB SIDE



210 PSOUB BAR



210 PSOUB SIDE

210 SIDE CHAIR

17¹/₂"W | 21"D | 34¹/₂"H | 18"SH | 15³/₄"SD

210 BARSTOOL

18¹/₄"W | 20³/₄"D | 43¹/₂"H | 30¹/₂"SH | 15³/₄"SD



OVERUPHOLSTERED BACK



TWO PIECE BACK

UV

INDOOR

215 SERIES

FEATURES

LACQUER FINISHES: Black, Cherry, Honey Oak, Mahogany or Walnut

UV FINISHES: 15 Standard Finishes

AVAILABLE WITH: Padded Seat Padded Back, Padded Seat Wrapped Sides Padded Back



215 PSPB SIDE

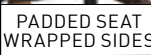

215 PSPB BAR

UV LACQUER		215 SIDE CHAIR	16 ³ / ₄ "W 19 ³ / ₄ "D 33 ¹ / ₂ "H 18"SH 16 ¹ / ₄ "SD
		215 BARSTOOL	19 ¹ / ₄ "W 19 ¹ / ₂ "D 42 ¹ / ₂ "H 30 ¹ / ₂ "SH 16 ³ / ₄ "SD

PADDED SEAT
WRAPPED SIDES

INDOOR

225 SERIES

FEATURES

LACQUER FINISHES: Black, Cherry, Honey Oak, Mahogany, Natural or Walnut

UV FINISHES: 15 Standard Finishes

AVAILABLE WITH: Saddle Seat, Veneer Seat, Padded Seat, Wrapped Sides, Padded Back, Padded Nail Back, Padded Inside Back



225 SS SIDE



225 PS SIDE

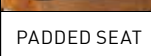

225 PSPB BAR

UV LACQUER		225 SIDE CHAIR	17 ¹ / ₂ "W 21"D 34 ¹ / ₂ "H 18"SH 16"SD
		225 BARSTOOL	18 ¹ / ₄ "W 20 ³ / ₄ "D 43 ¹ / ₂ "H 30 ¹ / ₂ "SH 16"SD

PADDED SEAT

PADDED
OUTSIDE BACK

SADDLE SEAT

23 SERIES

INDOOR

FEATURES

LACQUER FINISHES: Black, Mahogany, Natural or Walnut

UV FINISHES: 15 Standard Finishes

AVAILABLE WITH: Veneer Seat, Padded Seat, Padded Fan Back, Padded Nail Seat









23 VS ARM



23 PS BAR

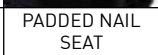
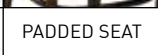
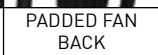

23 PSPFB SIDE

23 SIDE CHAIR	17"W 19 ¹ / ₄ "D 33 ¹ / ₄ "H 18 ³ / ₄ "SH 16 ¹ / ₄ "SD				LACQUER UV
23 ARMCHAIR	24 ¹ / ₄ "W 19 ¹ / ₂ "D 30 ¹ / ₂ "H 18 ³ / ₄ "SH 17 ¹ / ₂ "SD 27"AH				
23 BARSTOOL	21 ¹ / ₄ "W 20 ¹ / ₂ "D 41"H 30 ¹ / ₄ "SH 16 ¹ / ₄ "SD 38 ³ / ₄ "AH				

PADDED NAIL
SEAT

PADDED SEAT

PADDED FAN
BACK

302 SERIES

INDOOR

FEATURES

LACQUER FINISHES: Black, Mahogany or Walnut

UV FINISHES: 15 Standard Finishes

AVAILABLE WITH: Veneer Seat, Padded Seat, Padded Nail Seat







302 VS BAR



302 PNS BAR

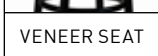
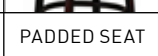

302 PS BAR

302 BARSTOOL	18"W 18"D 30"H 30"SH 16 ¹ / ₄ "SD				LACQUER UV
					

VENEER SEAT

PADDED SEAT

PADDED NAIL
SEAT

INDOOR

314 SERIES

FEATURES

UV FINISHES: 15 Standard Finishes
 AVAILABLE WITH: Padded Seat, Padded Nail Seat
Note: Garhyde and Symphony Vintage vinyls cannot be used for upholstery



314 PS BAR



314 PNS BAR

UV			314 BARSTOOL	22"W 22 ¹ / ₂ "D 30"H 30"SH 17 ³ / ₄ "SD
	PADDED SEAT	PADDED NAIL SEAT		

604 SERIES

INDOOR

FEATURES

LACQUER FINISHES: Black, Cherry, Mahogany, Natural or Walnut
 UV FINISHES: 15 Standard Finishes
 AVAILABLE WITH: Saddle Seat, Padded Seat, Wrapped Sides



604 PSWS BAR



604 PS BAR



604 SS BAR

LACQUER	UV				604 BARSTOOL	16 ³ / ₄ "W 16 ³ / ₄ "D 30 ³ / ₄ "H 30 ³ / ₄ "SH 15 ¹ / ₂ "SD
		PADDED SEAT WRAPPED SIDES	PADDED SEAT	SADDLE SEAT		

INDOOR

379 SERIES

FEATURES

UV FINISHES: 15 Standard Finishes
 AVAILABLE WITH: Saddle Seat, Padded Seat, Pullover Seat, Pullover Seat Padded Nail Back



379 SS SIDE



379 POS ARM



379 POSPNB BAR

UV				379 SIDE CHAIR	19 ¹ / ₄ "W 20 ¹ / ₂ "D 35"H 18 ¹ / ₂ "SH 16 ¹ / ₂ "SD
	SADDLE SEAT	PULLOVER SEAT	OUTSIDE NAIL BACK	379 ARMCHAIR	22 ¹ / ₄ "W 21"D 35"H 18 ¹ / ₂ "SH 16 ¹ / ₂ "SD 27 ³ / ₄ "AH
				379 BARSTOOL	18"W 19"D 44"H 30 ³ / ₄ "SH 16 ¹ / ₄ "SD

FEATURES

LACQUER FINISHES: Black, Mahogany, Natural or Walnut
 UV FINISHES: 15 Standard Finishes
 AVAILABLE WITH: Veneer Seat, Padded Seat, Padded Nail Seat



788 PS SIDE



788 PNS BAR



788 VS SIDE

LACQUER	UV				788 SIDE CHAIR	17 ³ / ₄ "W 18 ³ / ₄ "D 31"H 18 ³ / ₄ "SH 16 ¹ / ₄ "SD
		PADDED NAIL SEAT	PADDED SEAT	VENEER SEAT	788 BARSTOOL	17 ³ / ₄ "W 18 ¹ / ₂ "D 42 ¹ / ₄ "H 30 ¹ / ₄ "SH 16 ¹ / ₄ "SD

INDOOR

CC100 SERIES



FEATURES

UV FINISHES: 15 Standard Finishes

AVAILABLE WITH: Saddle Seat, Padded Seat, Wrapped Sides, Padded Back



CC100 SS



CC100 SS ARM



CC100 PSWS BAR

UV				CC100 SIDE CHAIR	21"W 21"D 33 ³ / ₄ "H 18 ¹ / ₂ "SH 17 ³ / ₄ "SD	
	PADDED BACK	PADDED SEAT	WRAPPED SIDES	CC100 ARMCHAIR	24 ¹ / ₂ "W 22 ¹ / ₂ "D 33 ³ / ₄ "H 18 ¹ / ₂ "SH 17 ³ / ₄ "SD 26"AH	
				CC100 BARSTOOL	19 ³ / ₄ "W 21"D 43 ¹ / ₂ "H 30 ¹ / ₂ "SH 17 ³ / ₄ "SD	

CC106 SERIES

INDOOR



FEATURES

UV FINISHES: 15 Standard Finishes

AVAILABLE WITH: Padded Seat Padded Back, Padded Seat Padded Nail Back, Wrapped Sides



CC106 PSWSPB ARM



CC106 PSPB BAR



CC106 PSPB SIDE

CC106 SIDE CHAIR	21 ¹ / ₂ "W 22 ¹ / ₂ "D 36 ¹ / ₂ "H 18 ¹ / ₂ "SH 17 ³ / ₄ "SD					UV
CC106 ARMCHAIR	24 ¹ / ₂ "W 22 ¹ / ₂ "D 37"H 18 ¹ / ₂ "SH 17 ³ / ₄ "SD 26"AH		PADDED BACK	WRAPPED SIDES	PADDED NAIL BACK	
CC106 BARSTOOL	18 ³ / ₄ "W 21"D 45 ¹ / ₂ "H 30 ¹ / ₂ "SH 17 ³ / ₄ "SD					

INDOOR

CC105 SERIES



FEATURES

UV FINISHES: 15 Standard Finishes

AVAILABLE WITH: Saddle Seat, Padded Seat, Wrapped Sides



CC105 SS SIDE



CC105 PS ARM



CC105 PSWS BAR

UV				CC105 SIDE CHAIR	21 ¹ / ₂ "W 22 ¹ / ₂ "D 36 ¹ / ₂ "H 18 ¹ / ₂ "SH 17 ³ / ₄ "SD	
	SADDLE SEAT	PADDED SEAT	WRAPPED SIDES	CC105 ARMCHAIR	24 ¹ / ₂ "W 22 ¹ / ₂ "D 37"H 18 ¹ / ₂ "SH 17 ³ / ₄ "SD 26"AH	
				CC105 BARSTOOL	18 ³ / ₄ "W 21"D 45 ¹ / ₂ "H 30 ¹ / ₂ "SH 17 ³ / ₄ "SD	

CC107 SERIES

INDOOR



FEATURES

UV FINISHES: 15 Standard Finishes

AVAILABLE WITH: Padded Seat Overupholstered Back, Wrapped Sides, Two Piece Back

Note: Garhyde and Symphony Vintage vinyls cannot be used for upholstery



CC107 PSWSOUB ARM



CC107 PSWSOUB BAR



CC107 PSOUB SIDE

CC107 SIDE CHAIR	21 ¹ / ₂ "W 23"D 36 ³ / ₄ "H 18 ¹ / ₂ "SH 17 ³ / ₄ "SD				UV
CC107 ARMCHAIR	24 ¹ / ₂ "W 23"D 37"H 18 ¹ / ₂ "SH 17 ³ / ₄ "SD 26"AH		PADDED SEAT	WRAPPED SIDES	
CC107 BARSTOOL	18 ³ / ₄ "W 21 ¹ / ₂ "D 45 ¹ / ₄ "H 30 ¹ / ₂ "SH 17 ¹ / ₂ "SD				

INDOOR

CC110 SERIES



FEATURES

UV FINISHES: 15 Standard Finishes

AVAILABLE WITH: Saddle Seat, Padded Seat, Wrapped Sides



CC110 SS SIDE



CC110 PS ARM



CC110 PS BAR

UV				CC110 SIDE CHAIR	22"W 22 1/2"D 36 3/4"H 18 1/2"SH 17 3/4"SD	
				CC110 ARMCHAIR	24 1/2"W 22 1/2"D 37"H 18 1/2"SH 17 3/4"SD 26"AH	
				CC110 BARSTOOL	18 3/4"W 21"D 45 1/2"H 30 1/2"SH 17 3/4"SD	

CC115 SERIES

INDOOR



FEATURES

UV FINISHES: 15 Standard Finishes

AVAILABLE WITH: Padded Seat, Padded Back, Padded Nail Back, Wrapped Sides



CC115 PSWSPB ARM



CC115 PSWSPB BAR



CC115 PSPB SIDE

CC115 SIDE CHAIR	20 1/4"W 22"D 35 1/4"H 18 1/2"SH 17 3/4"SD					UV
CC115 ARMCHAIR	24 1/2"W 22"D 35 1/4"H 18 1/2"SH 17 3/4"SD 26"AH					
CC115 BARSTOOL	18 1/2"W 21 3/4"D 45 3/4"H 30 1/2"SH 17 3/4"SD					

INDOOR

CC111 SERIES



FEATURES

UV FINISHES: 15 Standard Finishes

AVAILABLE WITH: Padded Seat, Padded Slat Back, Padded Wrapped Sides



CC111 PSPSB SIDE



CC111 PSPSB ARM



CC111 PSPSB BAR

UV			CC111 SIDE CHAIR	22"W 22 1/2"D 36 3/4"H 18 1/2"SH 17 3/4"SD	
			CC111 ARMCHAIR	24 1/2"W 22 1/2"D 37"H 18 1/2"SH 17 3/4"SD 26"AH	
			CC111 BARSTOOL	18 3/4"W 21"D 45 1/2"H 30 1/2"SH 17 3/4"SD	

CC119 SERIES

INDOOR



FEATURES

UV FINISHES: 15 Standard Finishes

AVAILABLE WITH: Padded Seat Wrapped Sides Padded Hole Back

Note: Garhyde and Symphony Vintage vinyls cannot be used for upholstery



CC119 PSWSPHB ARM



CC119 PSWSPHB BAR



CC119 PSWSPHB SIDE

CC119 SIDE CHAIR	20 1/4"W 22 1/4"D 35 1/2"H 18 1/2"SH 17 3/4"SD				UV
CC 119 ARMCHAIR	24 1/2"W 22 1/4"D 35 1/2"H 18 1/2"SH 17 3/4"SD 26"AH				
CC119 BARSTOOL	18 1/2"W 22"D 46"H 30 1/2"SH 17 3/4"SD				

INDOOR

CC135 SERIES



FEATURES

UV FINISHES: 15 Standard Finishes

AVAILABLE WITH: Saddle Seat, Padded Seat, Wrapped Sides



CC135 SS SIDE



CC135 PS ARM



CC135 PSWS BAR

UV				CC135 SIDE CHAIR	21 ¹ / ₂ "W 21 ¹ / ₂ "D 35 ¹ / ₂ "H 18 ¹ / ₂ "SH 17 ³ / ₄ "SD	
	SADDLE SEAT	PADDED SEAT	WRAPPED SIDES	CC135 ARMCHAIR	24 ¹ / ₂ "W 22"D 35 ¹ / ₂ "H 18 ¹ / ₂ "SH 17 ³ / ₄ "SD 26"AH	
				CC135 BARSTOOL	20"W 21"D 45"H 30 ¹ / ₂ "SH 17 ³ / ₄ "SD	

CC176 SERIES

INDOOR

FEATURES

UV FINISHES: 15 Standard Finishes

AVAILABLE WITH: Padded Seat, Padded Seat Wrapped Sides, Padded Back



CC176 PS ARM



CC176 PS BAR



CC176 PS SIDE

CC176 SIDE CHAIR	19"W 20 ³ / ₄ "D 34 ¹ / ₂ "H 18 ¹ / ₂ "SH 17 ³ / ₄ "SD				UV
CC176 ARMCHAIR	24 ¹ / ₂ "W 20 ³ / ₄ "D 34 ¹ / ₂ "H 18 ¹ / ₂ "SH 17 ³ / ₄ "SD 26"AH		PADDED SEAT	PADDED BACK	
CC176 BARSTOOL	19 ¹ / ₂ "W 21 ¹ / ₄ "D 43 ¹ / ₂ "H 30 ¹ / ₂ "SH 17 ³ / ₄ "SD		WRAPPED SIDES		

INDOOR

CC170 SERIES

FEATURES

UV FINISHES: 15 Standard Finishes

AVAILABLE WITH: Padded Seat, Padded Seat Wrapped Sides, Padded Back



CC170 PS SIDE



CC170 PS ARM



CC170 PS BAR

UV			CC170 SIDE CHAIR	21 ¹ / ₄ "W 22"D 34"H 18 ¹ / ₂ "SH 17 ³ / ₄ "SD	
	PADDED SEAT	PADDED BACK	CC170 ARMCHAIR	24 ¹ / ₂ "W 22"D 34"H 18 ¹ / ₂ "SH 17 ³ / ₄ "SD 26"AH	
	WRAPPED SIDES		CC170 BARSTOOL	20"W 22 ¹ / ₄ "D 44"H 30 ¹ / ₂ "SH 17 ³ / ₄ "SD	

GS 90 SERIES

INDOOR

FEATURES



UV FINISHES: 15 Standard Finishes

AVAILABLE WITH: Padded Seat



GS 90 PS BAR



GS 90 PS SIDE

GS 90 SIDE CHAIR	19 ¹ / ₄ "W 20 ¹ / ₄ "D 33 ¹ / ₄ "H 18 ¹ / ₂ "SH 17 ¹ / ₂ "SD			UV
GS 90 BARSTOOL	18"W 20 ¹ / ₄ "D 42"H 30"SH 16"SD		PADDED SEAT	

INDOOR

GS 95 SERIES

FEATURES



UV FINISHES: 15 Standard Finishes
 AVAILABLE WITH: Padded Seat



GS 95 PS SIDE

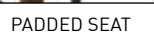

GS 95 PS BAR

UV		GS 95 SIDE CHAIR	19 ¹ / ₄ "W 20 ¹ / ₄ "D 34 ¹ / ₄ "H 18 ¹ / ₂ "SH 17 ¹ / ₂ "SD	
		GS 95 BARSTOOL	18"W 20 ¹ / ₄ "D 43"H 30"SH 16"SD	
	PADDED SEAT			

INDOOR

HÄGEN SERIES

NEW

FEATURES

UV FINISHES: 15 Standard Finishes
 AVAILABLE WITH: Veneer Seat, Padded Seat, Padded Inset Seat, Padded Seat Padded Back, Padded Inset Seat Padded Back







HÄGEN PS SIDE



HÄGEN PISPB ARM

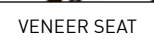

HÄGEN PS BAR

UV				HÄGEN SIDE CHAIR	20"W 19 ¹ / ₂ "D 34 ¹ / ₂ "H 18 ¹ / ₂ "SH 16"SD
				HÄGEN ARMCHAIR	24 ¹ / ₂ "W 22"D 34 ¹ / ₂ "H 18"SH 18"SD 26 ³ / ₄ "AH
	VENEER SEAT	PADDED SEAT	PADDED INSET SEAT	HÄGEN BARSTOOL	21"W 20 ¹ / ₂ "D 42"H 31"SH 16"SD

NEW

HENRIK SERIES

INDOOR

FEATURES

UV FINISHES: 15 Standard Finishes
 AVAILABLE WITH: Box Seat Overupholstered Hole Back



HENRIK BSOUHB ARM



HENRIK BSOUHB BAR



HENRIK BSOUHB SIDE

HENRIK SIDE CHAIR	21 ³ / ₄ "W 24"D 34 ¹ / ₂ "H 18"SH 17"SD		UV
HENRIK ARMCHAIR	25"W 26"D 32"H 18"SH 17"SD 26"AH		
HENRIK BARSTOOL	22 ³ / ₄ "W 23 ¹ / ₄ "D 43 ¹ / ₂ "H 30"SH 16 ¹ / ₂ "SD		
		BOX SEAT	

NEW

JARL SERIES

INDOOR

FEATURES



UV FINISHES: 15 Standard Finishes
 AVAILABLE WITH: Veneer Seat, Padded Seat



JARL PS BAR



JARL PS SIDE

JARL SIDE CHAIR	20 ¹ / ₄ "W 21 ³ / ₄ "D 33 ¹ / ₂ "H 17 ³ / ₄ "SH 16"SD		
JARL BARSTOOL	20 ³ / ₄ "W 20"D 42 ¹ / ₄ "H 28 ¹ / ₂ "SH 16"SD	VENEER SEAT	PADDED SEAT

INDOOR

MATTEO SERIES

NEW

FEATURES

UV FINISHES: 15 Standard Finishes

AVAILABLE WITH: Box Seat Overupholstered Back, Box Seat Overupholstered Hole Back



MATTEO BS0UB SIDE



MATTEO BS0UHB ARM



MATTEO BS0UB BAR

UV		MATTEO SIDE CHAIR	19 ¹ / ₂ "W 20 ³ / ₄ "D 33 ¹ / ₄ "H 18"SH
		MATTEO ARMCHAIR	22 ¹ / ₄ "W 25"D 33 ¹ / ₄ "H 18"SH 26 ¹ / ₄ "AH
		MATTEO BARSTOOL	21"W 22"D 42"H 30"SH

INDOOR

No. 43 SERIES

NEW

FEATURES

LACQUER FINISHES: Black or Walnut

AVAILABLE WITH: Padded Seat, Padded Seat Padded Hole Back, Padded Seat Button Tufted Hole Back, Padded Seat Overupholstered Hole Back



No. 43 PSBTHB SIDE



No. 43 PS BAR

LACQUER		No. 43 SIDE CHAIR	18"W 20 ¹ / ₂ "D 32 ¹ / ₄ "H 18"SH 15 ¹ / ₂ "SD
		No. 43 BARSTOOL	19 ¹ / ₂ "W 20"D 42 ¹ / ₄ "H 30"SH 15 ¹ / ₂ "SD

NEW

No. 4303 SERIES

INDOOR

FEATURES

LACQUER FINISHES: Black, Natural or Walnut

AVAILABLE WITH: Veneer Seat, Padded Seat, Padded Nail Seat



NO. 4303 PS BACKLESS BAR



No. 4303 VS BACKLESS BAR

No. 4303 BACKLESS BAR	14 ¹ / ₂ "W 14 ¹ / ₂ "D 31 ¹ / ₂ "H 14 ¹ / ₂ "SD				LACQUER
		VENEER SEAT	PADDED SEAT	PADDED NAIL SEAT	

NEW

No. 6010 SERIES

INDOOR

FEATURES

LACQUER FINISHES: Black or Walnut

AVAILABLE WITH: Veneer Seat, Padded Seat, Padded Nail Seat



No. 6010 VS ARM



No. 6010 VS SIDE

No. 6010 SIDE CHAIR	17 ³ / ₄ "W 20 ¹ / ₂ "D 31 ³ / ₄ "H 18 ¹ / ₂ "SH 15 ¹ / ₂ "SD				LACQUER
No. 6010 ARMCHAIR	19 ¹ / ₂ "W 20 ¹ / ₂ "D 31 ³ / ₄ "H 18 ¹ / ₂ "SH 15 ¹ / ₂ "SD	PADDED NAIL SEAT	PADDED SEAT	VENEER SEAT	

INDOOR

No. 8140 SERIES

NEW

FEATURES

LACQUER FINISHES: Black, Natural or Walnut
 Note: Black finish not available on side chair.
 AVAILABLE WITH: Veneer Seat, Padded Seat, Padded Nail Seat, Handcane Back



No. 8140 VS SIDE



No. 8140 VS ARM



No. 8140 VS BAR

LACQUER				No. 8140 SIDE CHAIR	17 ¹ / ₂ "W 20 ³ / ₄ "D 31 ³ / ₄ "H 18"SH 15 ¹ / ₂ "SD
				No. 8140 ARMCHAIR	20"W 20 ³ / ₄ "D 31 ³ / ₄ "H 18"SH 15 ¹ / ₂ "SD
				No. 8140 BARSTOOL	17 ¹ / ₄ "W 19 ³ / ₄ "D 42 ³ / ₄ "H 30"SH 15 ¹ / ₂ "SD

QUINCY SERIES

INDOOR

FEATURES



UV FINISHES: 15 Standard Finishes
 AVAILABLE WITH: Padded Seat Padded Back, Wrapped Sides



QUINCY PSWSPB ARM



QUINCY PSPB BAR



QUINCY PSPB SIDE

QUINCY SIDE CHAIR	20 ¹ / ₄ "W 22"D 35 ¹ / ₄ "H 18 ¹ / ₂ "SH 17 ³ / ₄ "SD				UV
QUINCY ARMCHAIR	24 ¹ / ₂ "W 22"D 35 ¹ / ₄ "H 18 ¹ / ₂ "SH 17 ³ / ₄ "SD 26 ¹ / ₄ "AH				
QUINCY BARSTOOL	18 ¹ / ₂ "W 21 ³ / ₄ "D 45 ³ / ₄ "H 30 ¹ / ₂ "SH 17 ¹ / ₄ "SD				

INDOOR

No. 8291 SERIES

NEW

FEATURES

LACQUER FINISHES: Black or Walnut
 AVAILABLE WITH: Veneer Seat, Padded Seat, Padded Nail Seat



No. 8291 VS SIDE



No. 8291 VS BAR

LACQUER				No. 8291 SIDE CHAIR	17 ¹ / ₂ "W 20 ³ / ₄ "D 31 ³ / ₄ "H 18"SH 15 ³ / ₄ "SD
				No. 8291 BARSTOOL	18"W 20"D 42 ¹ / ₂ "H 29 ³ / ₄ "SH 15 ¹ / ₂ "SD

NEW

SØREN SERIES

INDOOR

FEATURES

UV FINISHES: 15 Standard Finishes
 AVAILABLE WITH: Veneer Seat, Padded Inset Seat, Padded Inset Seat Padded Back



SØREN PISPB ARM



SØREN PIS BAR



SØREN VS SIDE

SØREN SIDE CHAIR	18 ³ / ₄ "W 21 ¹ / ₂ "D 30 ³ / ₄ "H 18"SH 16"SD				UV
SØREN ARMCHAIR	22 ¹ / ₄ "W 22 ¹ / ₂ "D 30 ¹ / ₂ "H 18"SH 16"SD 26 ¹ / ₄ "AH				
SØREN BARSTOOL	22 ¹ / ₄ "W 22"D 43 ³ / ₄ "H 30 ³ / ₄ "SH 16"SD				

INDOOR

STEN SERIES

NEW

FEATURES

UV FINISHES: 15 Standard Finishes

AVAILABLE WITH: Overupholstered Seat Overupholstered Back

Note: Garhyde and Symphony Vintage vinyls cannot be used for upholstery



STEN OUSOUB SIDE



STEN OUSOUB BAR

UV OVERUPHOLSTERED	STEN SIDE CHAIR	17 ¹ / ₂ "W 22 ¹ / ₂ "D 34 ³ / ₄ "H 18 ³ / ₄ "SH 16"SD
	STEN BARSTOOL	20 ¹ / ₄ "W 20 ³ / ₄ "D 45 ³ / ₄ "H 30"SH 16"SD

INDOOR

VERA SERIES

NEW

FEATURES

UV FINISHES: 15 Standard Finishes

AVAILABLE WITH: Padded Seat Padded Back



VERA PSPB SIDE



VERA PSPB ARM



VERA PSPB BAR

UV PADDED SEAT PADDED BACK	VERA SIDE CHAIR	17 ¹ / ₄ "W 19"D 38 ¹ / ₂ "H 18"SH 16"SD
	VERA ARMCHAIR	22 ¹ / ₂ "W 19 ³ / ₄ "D 38 ¹ / ₂ "H 18"SH 16"SD 26"AH
	VERA BARSTOOL	22 ¹ / ₂ "W 23"D 38"H 30"SH 15"SD





THE FOUNDATION COLLECTION

A DYNAMIC DESIGN COLLECTION WHERE THE
CHAIR BECOMES THE BLANK CANVAS TO CREATE
YOUR MASTERPIECE.



01 UNIVERSAL FRAME

Starting with a classically styled frame, select from 12 different back styles, choose from countless combinations of upholstery, seats and armrests options to create your unique model.

02 SELECT A SEAT

Padded Seat? Inset Seat? Or a classic Pullover style? The choice is yours.



PADDED SEAT (PSPB)



PADDED SEAT WRAPPED SIDES (PSWSPB)



PADDED INSET SEAT (PISPB)



BOX SEAT (BSPB)



PULLOVER SEAT (POSPB / POSOUB)



PULLOVER SEAT W/ WELT (POSWPB)



"V" PULLOVER SEAT (VPOS)



"T" PULLOVER SEAT (TPOS)

03 ADD AN ARM

Your design interpretation to produce armchair functionality at its highest level. Paint your installation to fit your client's needs with the perfect look



OVERUPHOLSTERED ARM (OUA)



STANDARD ARM (SA)



OUTSIDE PADDED ARM (OPA)



INSET PADDED ARM (IPA)



WRAPPED ARM (WA)

04 RELAX. WE GOT THIS.

Sit back and let our expert craftsmen fabricate your unique seat for chairs or barstools.



FOUNDATION **ALLEN SERIES**

FEATURES

UV FINISHES: 15 Standard Finishes
STANDARD WITH: Padded Seat Padded Back



ALLEN POSPB SIDE



ALLEN PSPBIPA ARM



ALLEN PSPB BAR

UV	ALLEN SIDE CHAIR	18 ¹ / ₂ "W 24 ¹ / ₄ "D 38"H 18 ¹ / ₄ "SH 17 ³ / ₄ "SD
	ALLEN ARMCHAIR	24"W 25"D 38"H 18 ¹ / ₄ "SH 18 ³ / ₄ "SD 26"AH
	ALLEN BARSTOOL	17"W 23 ¹ / ₄ "D 47"H 30 ¹ / ₂ "SH 17 ¹ / ₂ "SD

FOUNDATION **BEDFORD SERIES**

FEATURES

UV FINISHES: 15 Standard Finishes
STANDARD WITH: Pullover Seat Overupholstered Back



BEDFORD POSOUB SIDE



BEDFORD POSOUBOUA ARM



BEDFORD POSOUB BAR

UV	BEDFORD SIDE CHAIR	18 ¹ / ₂ "W 24 ¹ / ₄ "D 38"H 18 ¹ / ₄ "SH 17 ³ / ₄ "SD
	BEDFORD ARMCHAIR	24"W 25"D 38"H 18 ¹ / ₄ "SH 18 ¹ / ₂ "SD 26"AH
	BEDFORD BARSTOOL	17"W 23 ¹ / ₄ "D 47"H 30 ¹ / ₂ "SH 17"SD

BEDFORD LITE SERIES FOUNDATION

FEATURES

UV FINISHES: 15 Standard Finishes
STANDARD WITH: Pullover Seat Overupholstered Back



BEDFORD LITE POSOUB BAR



BEDFORD LITE POSOUB SIDE

BEDFORD LITE SIDE CHAIR	17"W 23 ¹ / ₂ "D 36 ¹ / ₄ "H 18 ¹ / ₂ "SH 17 ¹ / ₂ "SD	UV
BEDFORD LITE BARSTOOL	16"W 23 ¹ / ₂ "D 44"H 29 ¹ / ₂ "SH 16"SD	

BERGEN SERIES FOUNDATION

FEATURES

UV FINISHES: 15 Standard Finishes
STANDARD WITH: Padded Seat Padded Inside and Outside Back



BERGEN PSPBSA ARM



BERGEN PSPB BAR



BERGEN PSPB SIDE

BERGEN SIDE CHAIR	18 ¹ / ₂ "W 24 ¹ / ₄ "D 38"H 18 ¹ / ₄ "SH 18 ¹ / ₂ "SD	UV
BERGEN ARMCHAIR	24"W 25"D 38"H 18 ¹ / ₄ "SH 19"SD 26"AH	
BERGEN BARSTOOL	17"W 23 ¹ / ₄ "D 47"H 30 ¹ / ₂ "SH 17 ¹ / ₂ "SD	

CARLISLE SERIES

FEATURES

UV FINISHES: 15 Standard Finishes
STANDARD WITH: Padded Seat Padded Back



CARLISLE POSPB SIDE



CARLISLE POSPB ARM



CARLISLE POSPB BAR

UV	CARLISLE SIDE CHAIR	18 1/2"W 24 1/4"D 38"H 18 1/4"SH 18 1/2"SD
	CARLISLE ARMCHAIR	24"W 25"D 38"H 18 1/4"SH 19"SD 26"AH
	CARLISLE BARSTOOL	17"W 23 1/4"D 47"H 30 1/2"SH 17 1/2"SD

DRAKE SERIES

FEATURES

UV FINISHES: 15 Standard Finishes
STANDARD WITH: Padded Seat Woven Back



DRAKE PSWB BAR



DRAKE PSWB ARM



DRAKE PSWB SIDE

UV	DRAKE SIDE CHAIR	18 1/2"W 24 1/4"D 38"H 18 1/4"SH 17 3/4"SD
	DRAKE ARMCHAIR	24 1/2"W 25"D 38"H 18 1/4"SH 18 1/2"SD 26"AH
	DRAKE BARSTOOL	17"W 23 1/4"D 47"H 30 1/2"SH 17"SD

CARLISLE LITE SERIES

FEATURES

UV FINISHES: 15 Standard Finishes
STANDARD WITH: Pullover Seat Overupholstered Back



CARLISLE LITE POSPB SIDE



CARLISLE LITE POSPB BAR

UV	CARLISLE LITE SIDE CHAIR	17"W 23 1/2"D 35 3/4"H 18 1/2"SH 18"SD
	CARLISLE LITE BARSTOOL	16"W 23 1/2"D 44"H 29 1/2"SH 17"SD





Bedford Side
Alpha Phi House, University of Mississippi

ELLIS SERIES FOUNDATION

FEATURES

UV FINISHES: 15 Standard Finishes

STANDARD WITH: Padded Seat Padded Back



ELLIS POSPBSA ARM



ELLIS PSPB BAR



ELLIS PISPB SIDE

ELLIS SIDE CHAIR	18 ¹ / ₂ "W 24 ¹ / ₄ "D 38"H 18 ¹ / ₄ "SH 17 ³ / ₄ "SD	UV
ELLIS ARMCHAIR	24"W 25"D 38"H 18 ¹ / ₄ "SH 18 ³ / ₄ "SD 26"AH	
ELLIS BARSTOOL	17"W 23 ¹ / ₄ "D 47"H 30 ¹ / ₂ "SH 17 ¹ / ₂ "SD	

ELLIS LITE SERIES FOUNDATION

FEATURES

UV FINISHES: 15 Standard Finishes

STANDARD WITH: Padded Seat Padded Back



ELLIS LITE PSPB BAR



ELLIS LITE PSPB SIDE

ELLIS LITE SIDE CHAIR	17"W 23 ¹ / ₂ "D 35 ³ / ₄ "H 18 ¹ / ₂ "SH 18"SD	UV
ELLIS LITE BARSTOOL	16"W 23 ¹ / ₂ "D 44"H 29 ¹ / ₂ "SH 17"SD	

ESSEX SERIES

FEATURES

UV FINISHES: 15 Standard Finishes
 STANDARD WITH: Pullover Seat Button Tufted Back



ESSEX POSBTB SIDE



ESSEX POSBTB ARM



ESSEX POSBTB BAR

UV	ESSEX SIDE CHAIR	18 ¹ / ₂ "W 24 ¹ / ₄ "D 38"H 18 ¹ / ₄ "SH 17 ³ / ₄ "SD
	ESSEX ARMCHAIR	24"W 25"D 38"H 18 ¹ / ₄ "SH 18 ¹ / ₂ "SD 26"AH
	ESSEX BARSTOOL	17"W 23 ¹ / ₄ "D 47"H 30 ¹ / ₂ "SH 17"SD

FULTON SERIES

FEATURES

UV FINISHES: 15 Standard Finishes
 STANDARD WITH: Padded Seat Padded Back



FULTON PSPB SIDE



FULTON PSPBWA ARM



FULTON PSPB BAR

UV	FULTON SIDE CHAIR	18 ¹ / ₂ "W 24 ¹ / ₄ "D 38"H 18 ¹ / ₄ "SH 17 ³ / ₄ "SD
	FULTON ARMCHAIR	24"W 25"D 38"H 18 ¹ / ₄ "SH 18 ³ / ₄ "SD 26"AH
	FULTON BARSTOOL	17"W 23 ¹ / ₄ "D 47"H 30 ¹ / ₂ "SH 17 ¹ / ₂ "SD

HENRY SERIES

FEATURES

UV FINISHES: 15 Standard Finishes
 STANDARD WITH: Pullover Seat Overupholstered Back



HENRY POSOUBOUA ARM



HENRY POSOUB BAR



HENRY VOPSOUB SIDE

UV	HENRY SIDE CHAIR	18 ¹ / ₂ "W 24 ¹ / ₄ "D 38"H 18 ¹ / ₄ "SH 17 ³ / ₄ "SD
	HENRY ARMCHAIR	24"W 25"D 38"H 18 ¹ / ₄ "SH 18 ¹ / ₂ "SD 26"AH
	HENRY BARSTOOL	17"W 23 ¹ / ₄ "D 47"H 30 ¹ / ₂ "SH 17"SD

JACKSON SERIES

FEATURES

UV FINISHES: 15 Standard Finishes
 STANDARD WITH: Padded Seat Padded Back



JACKSON PSPB ARM



JACKSON PSPB BAR



JACKSON PSWSPB SIDE

UV	JACKSON SIDE CHAIR	18 ¹ / ₂ "W 24 ¹ / ₄ "D 38"H 18 ¹ / ₄ "SH 17 ¹ / ₂ "SD
	JACKSON ARMCHAIR	24"W 25"D 38"H 18 ¹ / ₄ "SH 18 ¹ / ₂ "SD 26"AH
	JACKSON BARSTOOL	17"W 23 ¹ / ₄ "D 47"H 30 ¹ / ₂ "SH 17"SD

FOUNDATION **JACKSON LITE SERIES**

FEATURES

UV FINISHES: 15 Standard Finishes
STANDARD WITH: Padded Seat Padded Back



JACKSON LITE PSPB SIDE



JACKSON LITE PSPB BAR

UV	JACKSON SIDE CHAIR	17"W 23 1/2"D 35 3/4"H 18 1/2"SH 17 1/2"SD
	JACKSON BARSTOOL	16"W 23 1/2"D 44"H 29 1/2"SH 16 1/2"SD

MERCER LITE SERIES FOUNDATION

FEATURES

UV FINISHES: 15 Standard Finishes
STANDARD WITH: Padded Seat Padded Bac



MERCER LITE PSPB BAR



MERCER LITE PSPB SIDE

MERCER LITE SIDE CHAIR	17"W 23 1/2"D 35 3/4"H 18 1/2"SH 18"SD	UV
MERCER LITE BARSTOOL	16"W 23 1/2"D 44"H 29 1/2"SH 17"SD	

FOUNDATION **MERCER SERIES**

FEATURES

UV FINISHES: 15 Standard Finishes
STANDARD WITH: Padded Seat Padded Back



MERCER PISPB SIDE



MERCER PSPBSA ARM



MERCER PSPB BAR

UV	MERCER SIDE CHAIR	18 1/2"W 24 1/4"D 38"H 18 1/4"SH 17 3/4"SD
	MERCER ARMCHAIR	24"W 25"D 38"H 18 1/4"SH 18 3/4"SD 26"AH
	MERCER BARSTOOL	17"W 23 1/4"D 47"H 30 1/2"SH 17 1/2"SD

WYATT SERIES FOUNDATION

FEATURES

UV FINISHES: 15 Standard Finishes
STANDARD WITH: Pullover Seat Overupholstered Back



WYATT PSWSCB ARM



WYATT PSWSCB BAR



WYATT PSWSCB SIDE

WYATT SIDE CHAIR	18 1/2"W 24 1/4"D 38"H 18 1/4"SH 17 3/4"SD	UV
WYATT ARMCHAIR	24"W 25"D 38"H 18 1/4"SH 18 1/2"SD 26"AH	
WYATT BARSTOOL	17"W 23 1/4"D 47"H 30 1/2"SH 17"SD	



LOUNGE SEATING

LOUNGE

CARNEGIE BORNE SETTEE

FEATURES

LACQUER FINISHES: Black, Cherry, Honey Oak, Mahogany,
 Natural or Walnut
 STANDARD WITH: Channeled Back and Seat with Pleated Tufting
 Edge Detail
 OPTIONAL WITH: (4) Bolsters, (4) 16" x 16" and (4) 12" x 12" Pillows



CARNEGIE BORNE SETTEE | 36"H | 18"SH | 56 1/4"D

LACQUER

LOUNGE

COOPER TUB CHAIR

FEATURES

LACQUER FINISHES: Black, Cherry, Honey Oak, Mahogany,
 Natural or Wanut
 STANDARD WITH: Strap Webbing with Sewn Loose Cushion
 OPTIONAL WITH: (2) 12" x 12" Pillows



COOPER TUB CHAIR | 34"W | 32"D | 31"H | 17"SH | 23"SD | 31"AH

LACQUER

LEXINGTON LOUNGE CHAIR

LOUNGE

FEATURES

LACQUER FINISHES: Black, Cherry, Honey Oak, Mahogany, Natural or Walnut
 STANDARD WITH: Webbed Saet with Sewn Pullover Cover and Wood Trim Back
 Detail
 OPTIONAL WITH: Box Tufting or 29" x 7" Bolster Pillow



LEXINGTON LOUNGE CHAIR

30"W | 30 1/4"D | 32 1/2"H | 18"SH | 20 1/2"SD

LACQUER

MORGAN CLUB LOUNGE

LOUNGE

FEATURES

LACQUER FINISHES: Black, Cherry, Honey Oak, Mahogany, Natural or Walnut
 STANDARD WITH: Webbed Seat with Sewn Pullover Cover and Wood Trim Back
 Detail
 OPTIONAL WITH: 22" x 7" Bolster Pillow



MORGAN CLUB CHAIR

31"W | 34"D | 31 1/2"H | 18"SH | 23"SD | 23 1/4"AH

LACQUER

LOUNGE

THOMPSON WING CHAIR

FEATURES

LACQUER FINISHES: Black, Cherry, Honey Oak, Mahogany, Natural or Walnut

STANDARD WITH: Tight Seat Over Deck

OPTIONAL WITH: 22" x 10" Pillow



THOMPSON WING CHAIR | 31¹/₄"W | 34"D | 46³/₄"H | 17"SH | 23"SD | 26¹/₂"AH

LACQUER

LOUNGE

THOMPSON ARM AND SIDE CHAIR

FEATURES

LACQUER FINISHES: Black, Cherry, Honey Oak, Mahogany, Natural or Walnut

STANDARD WITH: Webbed Seat with Sewn Loose Seat Cushion



THOMPSON SIDE CHAIR | 22"W | 23¹/₂"D | 37³/₄"H | 18"SH | 16¹/₂"SD

THOMPSON ARMCHAIR | 24"W | 26"D | 38"H | 18"SH | 17³/₄"SD | 26¹/₂"AH

LACQUER





INDOOR TEXTILES

WITH AN ABUNDANCE OF COLOR AND
TEXTURES GALORE, WE HAVE A FABRIC TO
DRESS YOUR NEXT PROJECT.

AISLING WOOL

INDOOR



*WOOL
BLENDS AS
PLEASING
TO SIT ON
AS THEY
ARE TO SAY.*

APPLICATIONS

Hospitality, Contract, Residential Upholstery

GENERAL SPECIFICATIONS

WIDTH	54"
ROLL SIZE	55 - 60 Yards
WEIGHT	10 Ounces per Linear Yard
CONTENT	70% Wool / 20% Polyester / 5% Acrylic / 5% Nylon

PERFORMANCE SPECIFICATIONS

Abrasion Resistance	75,000+ DR per ASTM D4966- 12 Martindale
Seam Slippage	86.9 Warp / 56.0 Fill per ASTM 4034-92
Colorfastness to Crocking	5.0 Dry / 5.0 Wet per AATCC 8-2016
Colorfastness to Light	40 Hours - Class 5 per AATCC 16.3-2014, Option 3

FLAMMABILITY REQUIREMENTS*

California Technical Bulletin No. 117-2013
 UFAC Class 1
 NFPA 260

CLEANING INSTRUCTIONS

Cleaning Code: S/WS
 Spot clean using water-free solvent or dry
 cleaning product.
 Cleaning by a professional service is recommended.

DROMORE





*THIS SUBTLE
LINEN-LIKE
TEXTURE IS A
REAL WORK
OF ART.*

APPLICATIONS

Hospitality, Contract, Residential Upholstery

GENERAL SPECIFICATIONS

WIDTH	54"
ROLL SIZE	Approx. 50 Yards
WEIGHT	19 / 20 Ounces per Linear Yard
CONTENT	92% Polyester / 8% Linen
FINISH	Resilience TX

PERFORMANCE SPECIFICATIONS

Abrasion Resistance	100,000+ DR per ASTM D4157 Wyzenbeek (#10 Cotton duck)
Seam Slippage	144.2 Warp / 128.2 Fill per ASTM 4034
Colorfastness to Crocking	4.5 Dry / 5.0 Wet per AATCC 8
Colorfastness to Light	40 Hours - Class 4 per AATCC 16

FLAMMABILITY REQUIREMENTS*
California Technical Bulletin No. 117-2013
UFAC Class 1
NFPA 260

CLEANING INSTRUCTIONS
Cleaning Code: S
Spot clean using water-free solvent or dry
cleaning product.
Cleaning by a professional service is recommended.

PROP 65 WARNING: This product may contain a chemical known to the State of California to cause cancer and birth defects or other reproductive harm.

*This term and any corresponding data refer to typical performance in the specific test indicated and should not be construed to imply the behavior of this or any other material under actual fire conditions.





*PART
MODERN.
PART
CLASSIC.
ALWAYS
TIMELESS.*



STOIC



FETCHING



SUBLIME



ELIXIR



OPULENT

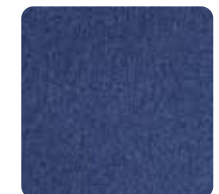

NIRVANA

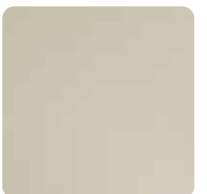

PERSUASION

APPLICATIONS

Hospitality, Contract, Residential Upholstery

GENERAL SPECIFICATIONS

WIDTH	54"
ROLL SIZE	Approx. 50 - 60 Yards
WEIGHT	15 / 16 Ounces per Linear Yard
CONTENT	100% Polyester
FINISH	Resilience TX

PERFORMANCE SPECIFICATIONS

Abrasion Resistance	100,000+ DR per ASTM D4157 Wyzenbeek (#10 Cotton duck)
Seam Slippage	96.7 Warp / 120.0 Fill per ASTM 4034
Colorfastness to Crocking	4.5 Dry / 5 Wet per AATCC 8
Colorfastness to Light	40 Hours - Class 4.5 per AATCC 16

FLAMMABILITY REQUIREMENTS*

California Technical Bulletin No. 117-2013
 UFAC Class 1
 NFPA 260

CLEANING INSTRUCTIONS

Cleaning Code: S
 Spot clean using water-free solvent or dry
 cleaning product.
 Cleaning by a professional service is recommended.

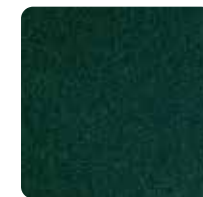

BUCOLIC



LUMEN

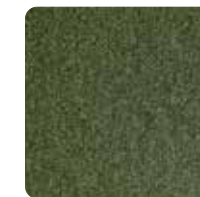

ETHEREAL



BROOD

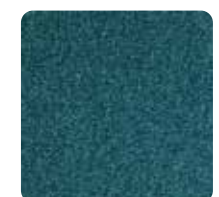

ELYSIAN

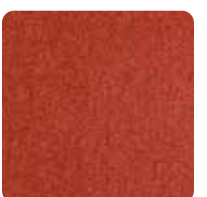

GREGARIOUS

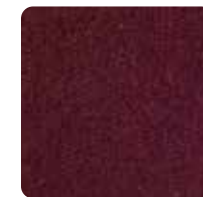

RADIANCE



EPOCH

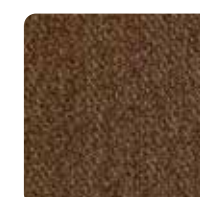

SONNET



QUINTESSENTIAL

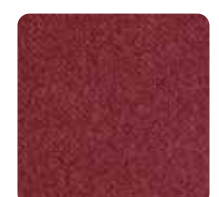

SEDUCTRESS

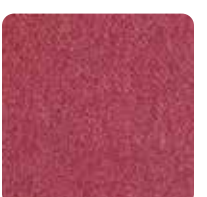

SERENDIPITY

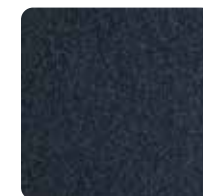

Matriarch



WHEREWITHAL



ARCADIAN

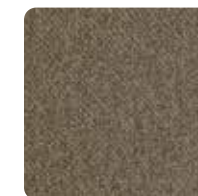

GRACIOUS

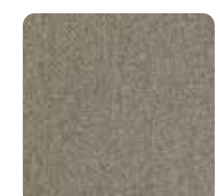

SONDER

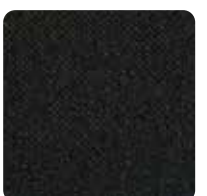

WISTFUL

PROP 65 WARNING: This product may contain a chemical known to the State of California to cause cancer and birth defects or other reproductive harm.

*This term and any corresponding data refer to typical performance in the specific test indicated and should not be construed to imply the behavior of this or any other material under actual fire conditions.

AVAILABLE
IN EVERY
COLOR
UNDER THE
SUN.

APPLICATIONS

Hospitality, Contract, Residential Upholstery

GENERAL SPECIFICATIONS

WIDTH	54"
ROLL SIZE	55 Yards
WEIGHT	15 / 16 Ounces per Linear Yard
CONTENT	70% Wool / 20% Polyester / 5% Nylon / 5% Acrylic

PERFORMANCE SPECIFICATIONS

Abrasion Resistance	100,000+ Cycles per ASTM D4966-12 Martindale
Seam Slippage	61.1 Warp / 41.6 Fill per ASTM D4034
Colorfastness to Crocking	5 Dry / 4 Wet per AATCC 8
Colorfastness to Light	40 Hours - Class 4.0 per AATCC 16

FLAMMABILITY REQUIREMENTS*

California Technical Bulletin No. 117-2013
UFAC Class 1
NFPA 260

CLEANING INSTRUCTIONS

Cleaning Code: S
Spot clean using water-free solvent or dry cleaning product.
Cleaning by a professional service is recommended.

PROP 65 WARNING: This product may contain a chemical known to the State of California to cause cancer and birth defects or other reproductive harm.

*This term and any corresponding data refer to typical performance in the specific test indicated and should not be construed to imply the behavior of this or any other material under actual fire conditions.



BIRDS & BEES

SKY'S THE LIMIT

STEEL MY THUNDER

APPLE A DAY

BATTLE ROYAL

CROCODILE TEARS

POTATO, POTATTO

SCOUT'S HONOR

CLOSE BUT NO CIGAR

BACK TO BASICS

EASY AS PIE

IT'S WITCHCRAFT

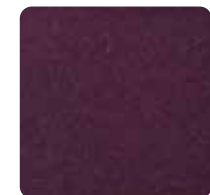

ABRACADABRA



DEVIL'S ADVOCATE



PACK LEADER

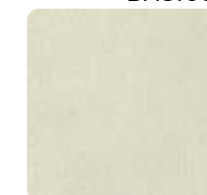

WHITE BREAD



GREASED LIGHTENING

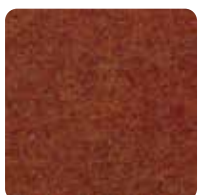

ALL BARK



HANKY PANKY

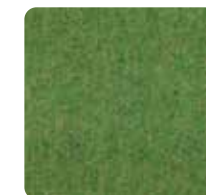

PINE AWAY



BROWNIE POINTS



OH NO SHE DIDN'T

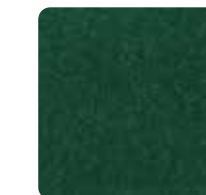

FILTHY RICH



INDIAN SUMMER

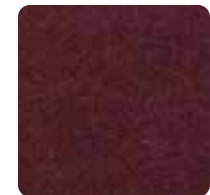

DINNER AND A SHOW



BAKER'S DOZEN



WILD BLUE YONDER

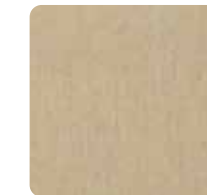

CATCH 22



*THIS VELVET IS
ALL DRESSED
UP WITH
EVERYWHERE
TO GO.*

APPLICATIONS

Hospitality, Contract, Residential Upholstery

GENERAL SPECIFICATIONS

WIDTH	54"
ROLL SIZE	Approx. 30 - 35 Yards
WEIGHT	20 / 21 Ounces per Linear Yard
CONTENT	60% Acrylic / 40% Polyester
FINISH	Resilience TX

PERFORMANCE SPECIFICATIONS

Abrasion Resistance	100,000+ DR per ASTM D4157 Wyzenbeek (#10 Cotton duck)
Seam Slippage	
Colorfastness to Crocking	93.4 Warp / 92.3 Fill per ASTM 4034
Colorfastness to Light	4.5 Dry / 4.5 Wet per AATCC 8 40 Hours - Class 5 per AATCC 16

FLAMMABILITY REQUIREMENTS*
California Technical Bulletin No. 117-2013
UFAC Class 1
NFPA 260

CLEANING INSTRUCTIONS
Cleaning Code: S
Spot clean using water-free solvent or dry
cleaning product.
Cleaning by a professional service is recommended.

PROP 65 WARNING: This product may contain a chemical known to the State of California to cause cancer and birth defects or other reproductive harm.

*This term and any corresponding data refer to typical performance in the specific test indicated and should not be construed to imply the behavior of this or any other material under actual fire conditions.



*COMFORT &
STYLE IN ALL
THE RIGHT
PLACES*



APPLICATIONS
Hospitality, Contract, Healthcare, Special & Industrial

GENERAL SPECIFICATIONS

WIDTH	54"
ROLL SIZE	30 Yards
WEIGHT	30 Ounces per Linear Yard
BACKING	100% Polyester Knit
SURFACE	100% PVC
FINISH	Resilience SR Protection

PERFORMANCE SPECIFICATIONS

Abrasion Resistance	250,000+ DR per ASTM D4157 Wyzenbeek / CFFA-6
Other Performance	Anti-Bacterial / Anti-Microbial
Cold Crack	-20° F Federal Standard No. 191A-Method 5874 / CFFA-6

FLAMMABILITY REQUIREMENTS*

California Technical Bulletin No. 117-2013
 UFAC Class 1
 NFPA 260
 IMO A.652
 Boston Fire Dept. BFD-IX-1
 Port Authority of NY/NJ
 MVSS302

CLEANING INSTRUCTIONS

Prompt cleaning is always recommended.
 Ordinary dirt and stains can be removed with mild soap and water. Rinse the cleaned area with clean water and dry with a lint free cloth.





*ORDINARY TO
EXTRAORDINARY*

APPLICATIONS

Hospitality, Contract, Special & Industrial Upholstery

GENERAL SPECIFICATIONS

WIDTH	54"
ROLL SIZE	40 Yards
WEIGHT	28 Ounces per Linear Yard
BACKING	100% Polyester Knit

PERFORMANCE SPECIFICATIONS

Abrasion Resistance	50,000+ DR per ASTM D4157-92 Wyzenbeek / CFFA-1A
Ultra Violet Resistant	200 Hours ASTM G26-96 Method C / CFFA-2
Cold Crack	-10° F Federal Standard No. 191A-Method 5874 / CFFA-6

FLAMMABILITY REQUIREMENTS*

California Technical Bulletin No. 117-2013
BIFMA X5.7-1991 Section 4
UFAC Class 1
NFPA 260

CLEANING INSTRUCTIONS

Prompt cleaning is always recommended.
Ordinary dirt and stains can be removed with mild soap and water. Rinse the cleaned area with clean water and dry with a lint free cloth.



PROP 65 WARNING: This product may contain a chemical known to the State of California to cause cancer and birth defects or other reproductive harm.

*This term and any corresponding data refer to typical performance in the specific test indicated and should not be construed to imply the behavior of this or any other material under actual fire conditions.

A dark, rectangular table base is shown lying on a wooden floor. The floor is made of wide, dark wood planks with a visible grain. The table base is a solid, dark color, possibly black or dark grey, and has a smooth, slightly reflective surface. It is positioned diagonally across the frame, with one corner pointing towards the bottom left. The lighting is dramatic, with strong shadows and highlights that emphasize the textures of both the wood and the table base.

INDOOR TABLE BASES



FSB SQUARE	FRAME	BLACK	SILVER
18" 21"			

NOTE: Zinc undercoated for indoor/outdoor use.



FSB ROUND	FRAME	BLACK	SILVER
18" 21" 29 ^{1/2} "			

NOTE: Zinc undercoated for indoor/outdoor use.



FSB RECTANGLE	FRAME	BLACK	SILVER
27" x 18"			

NOTE: Zinc undercoated for indoor/outdoor use.



FSB EB	FRAME	BLACK	SILVER
18"x9"			

NOTE: Zinc undercoated for indoor/outdoor use.



ANTOINETTE SERIES
22" 26" 32"
BLACK TEXTURE



EVA SERIES
15"
BLACK SEMI GLOSS



ARIEL SERIES
24"
BLACK SEMI GLOSS



FRANZ SERIES
15"
BLACK SEMI GLOSS



CLARISSE SERIES
17"
BLACK SEMI GLOSS



HUGO SERIES
15"
BLACK SEMI GLOSS



DANTE SERIES
24"
BLACK SEMI GLOSS



JAVIER SERIES
19"
BLACK SEMI GLOSS



JULIET SERIES
24"
BLACK SEMI GLOSS



RAFAEL SERIES
19"
BLACK SEMI GLOSS



PIETA SERIES
15"
BLACK SEMI GLOSS



TANGO SERIES
19"
BLACK SEMI GLOSS



PITTI SERIES
24"
BLACK SEMI GLOSS

GAR Products® Vintage table bases come with their own unique decorative standard height columns with decorative bar height columns also available for the Ariel, Dante, Eva, Franz, Hugo, Juliet, Pieta and Rafael style bases. The Antoinette, Clarisse, Pitti, Maria and Tango are available in bar height with a plain, non-decorative column.

ROUND



9000 SERIES
18" 20" 22" 26" 30"
BLACK TEXTURE

CROSS



900 SERIES
24" x 30" 22" 30" 33" 36"
BLACK TEXTURE

NOTE: Also available as End-Base.



9300 SERIES
22" 27"
BLACK TEXTURE

NOTE: Also available as End-Base.

STAINLESS STEEL

Suitable for indoor/outdoor use



FSS SQUARE SERIES
18" 21"
STAINLESS STEEL



FSS ROUND SERIES
18" 21" 29 1/2"
STAINLESS STEEL



FSS RECTANGLE SERIES
18" x 27 1/2"
STAINLESS STEEL
STANDARD WITH TWO COLUMNS



FSS TRIPLE ROUND SERIES
29 1/2"
STAINLESS STEEL
STANDARD WITH THREE COLUMNS

BOLT DOWN



1800 BOLT DOWN SERIES
TULIP COVER
7 5/8"
BLACK TEXTURE

NOTE: Also available as core drill



1800 BOLT DOWN SERIES
FLAT COVER
8"
BLACK TEXTURE

NOTE: Also available as core drill

All design, heavyweight and professional line table bases can be customized with larger column diameters and glide options, and cut down to any specified height for additional charges.

INDOOR TABLE TOPS





We offer a wide variety of mitered Wood Edge table tops in Red Oak, Maple and Ash wood options. Our tops are manufactured with a choice of either a horizontal grade laminate or veneer top surface as chosen by you, and bonded to a 45-pound high-density particle board with a phenolic backing sheet. All wood edges are available to match our UV house finishes, standard with a catalyzed conversion satin sheen finish. Custom finishes are also available on request.

Please note the edge wood grains will vary slightly from the European Beech wood used for our wood furniture.

All Wood Edge table tops are FOB PA.

NOTE: Crating fees may apply.

CHOOSE YOUR EDGE

From a variety of edge profiles for each style.

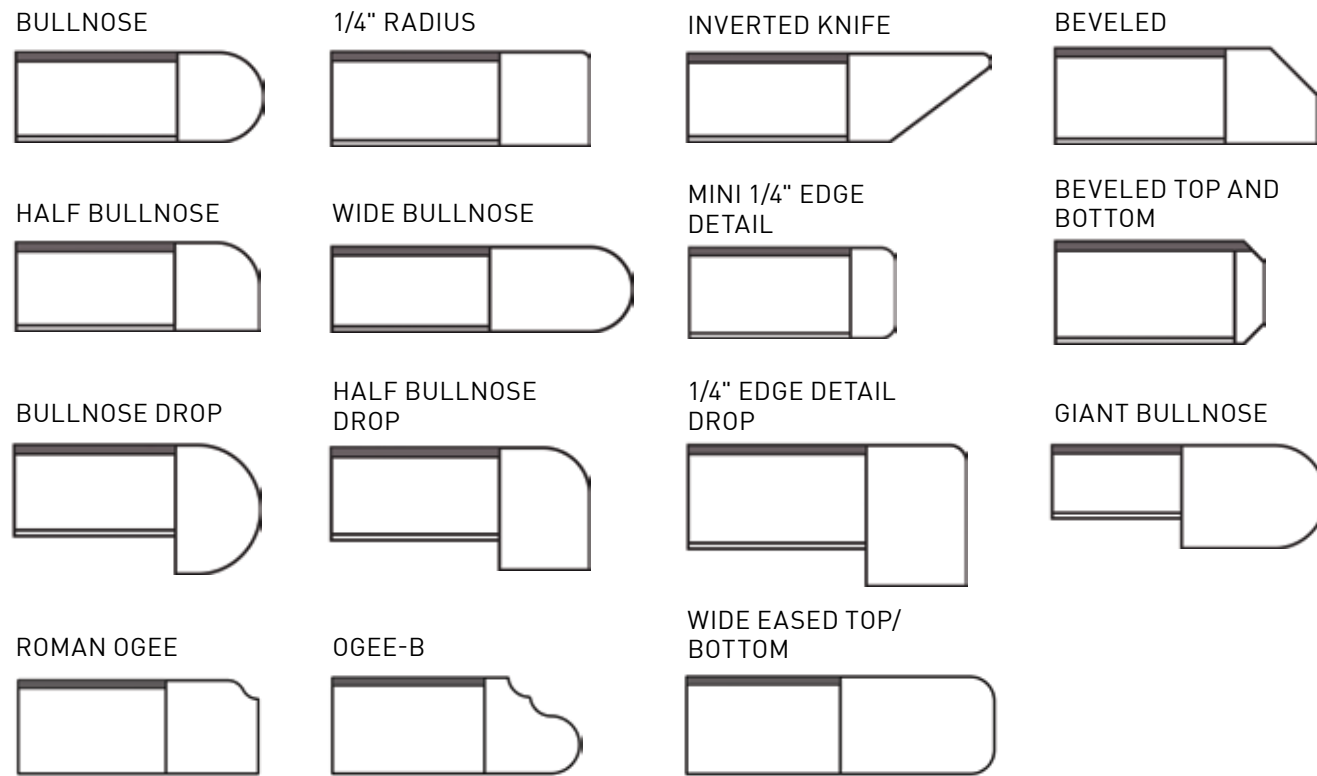

If you have any queries about selecting an edge profile, our sales reps and customer service associates can help you. For more options and finish color choices, please refer to our Price List or our website.



SOLID PLANK WOOD



SOLID BUTCHER BLOCK

We offer Solid Wood table tops in both Butcher Block and Plank construction in Red Oak or Maple wood species.

Solid Plank Wood tops are constructed with wood planks in equal length and random widths, laid edge to edge in a variety of top sizes in either a 1 1/4" or 1 3/4" thickness.

Continuous Butcher Block Solid Wood tops are constructed with uniform widths of solid wood, laid back to back in a continuous pattern.

Continuous Butcher Block tops are available in a variety of top sizes with either a 1 1/2" or 1 3/4" thickness.

The choice of stain to match GAR UV or lacquer finish colors are standard on all Solid Wood table tops. Custom stains are also available on request. All Solid Wood tops come standard with a durable Catalyzed Conversion Varnish.

All Solid Wood table tops are FOB WI.

NOTE: Crating fees may apply.

SOLID WOOD PLANK EDGE PROFILES

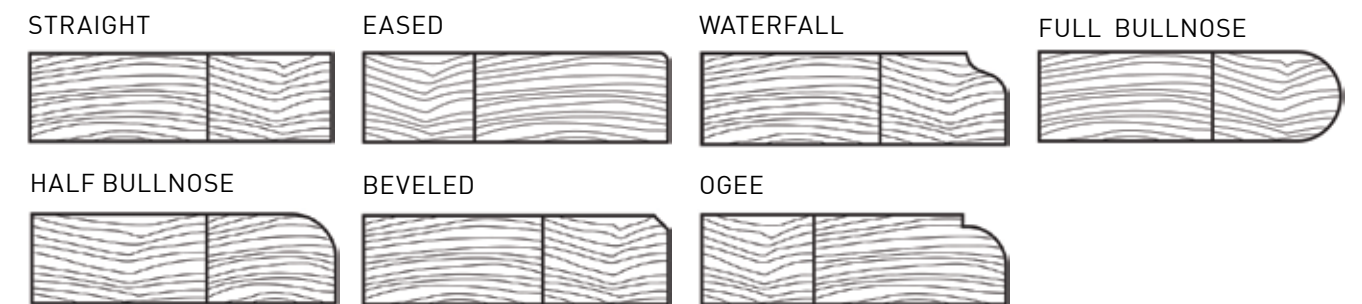

SOLID WOOD BUTCHER BLOCK EDGE PROFILES





We are excited to now offer barnwood table tops manufactured from reclaimed lumber. These table tops have a thickness of 1.5" and are available in either White Oak or Walnut. They come standard with an eased edge and has a low sheen commercial grade finish. Additional edge options are available upon request. All knots are filled with a black epoxy resin.

Please note the wood grains will vary from table top to table top.

All Barnwood table tops are
FOB PECULIAR, MO

NOTE: Crating fees may apply.

STANDARD BARNWOOD EDGE PROFILE

EASED

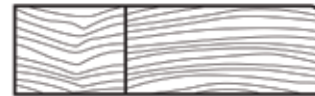

SIZES AVAILABLE IN EITHER
WHITE OAK OR WALNUT

24" X 24"	24" ROUND
24" X 30"	30" ROUND
30" X 30"	36" ROUND
30" X 36"	42" ROUND
30" X 42"	48" ROUND
30" X 48"	54" ROUND
30" X 60"	
30" X 72"	
36" X 36"	



SYNTHETIC EDGE



We offer three types of Synthetic Edge table tops: 3mm PVC, Vinyl Bullnose or Special Vinyl Bullnose edges, each available in a variety of colors. Our synthetic edge tops are manufactured to be used with either horizontal grade laminate or veneer surface. Top layer is bonded to 45-pound high-density particle board with a phenolic backing sheet.

All Synthetic Edge table tops are FOB PA.
NOTE: Crating fees may apply.

CHOOSE YOUR EDGE

VINYL BULLNOSE



SPECIAL VINYL BULLNOSE



3MM PVC



METAL EDGE



GAR Products offers smooth or fluted edges available in satin or polished finish options. Metal edge tops are offered with your selection of horizontal laminate or veneer surface and then bonded to 45-pound high-density particle board with a phenolic backing sheet.

All Metal Edge table tops are FOB PA.
NOTE: Crating fees may apply.

CHOOSE YOUR EDGE

SMOOTH



FLUTED



SELF EDGE



GAR Products® Self Edge table tops are an economical solution to wood table tops. Available with a variety of edge options, and with the choice of either a veneer or horizontal grade laminate surface and edge, these tops are the perfect solution for budget projects.

All Self Edge table tops are FOB PA.
NOTE: Crating fees may apply.

CHOOSE YOUR EDGE

SQUARE CORNERS



3" RADIUS CORNERS



2" DROP EDGE



PADDED EDGE



Padded table tops help eliminate the clattering sounds of china, stemware and silverware, offering your guests a silent fine dining experience. GAR Products® Padded Edge table tops are made of high density particle board wrapped with foam and covered with vinyl. The standard vinyl is Garyhde White. A custom plywood substrate is also available on request. All square to round Padded Edge table tops come standard with two table top hinges and one slide bar per leaf. Please note that round table tops with a diameter of 54" or larger will have a seam in the padding.

All Padded Edge table tops are FOB NJ.
NOTE: Crating fees apply.

If you have any queries about selecting an edge profile, our sales reps and customer service associates will help you. For more options and finish color choices, please refer to our Price List or our website.

IT'S ALL IN THE DETAILS

TABLE ACCESSORIES

GLIDES



TABLE SHOx



STEEL



NYLON

TABLE ACCESSORIES

SPIDERS



9" SPIDER



15" SPIDER



19" SPIDER

TABLE ACCESSORIES

MOUNTS



CANTILEVER SERIES	
WALL	16" x 33" 16" x 21"
FLOOR	28" x 32" 28" x 18"
BLACK	

Floor mounted cantilevers are also available.

COLUMNS

TABLE ACCESSORIES



STANDARD HT SERIES	
2" 3" 4"	
BLACK	

NOTE: Bar Height also available.



TELESCOPING SERIES	
30" or 39 1/2" 20 1/8" or 27 3/4"	
BLACK TEXTURE	

LEGS

TABLE ACCESSORIES



PIN LEG SERIES	
BOLT DOWN OR WITH GLIDE	
BLACK	

NOTE: Bar Height also available.

FOOTRESTS AND FOOTRINGS

TABLE ACCESSORIES



FOOTRING SERIES	
WAGON WHEEL 14" 19"	
BLACK	



FOOTRING SERIES	
STAND UP 22"	
BLACK	



FOOTREST SERIES	
TRIANGULAR	
BLACK	

NOTE: Only for use on Bolt Down Bases.

NAILHEADS

Most of our chairs can be designed to accommodate decorative nailhead trimmings. Never laid out by machine, our craftspeople apply nailheads by hand, individually, in a nail-to-nail pattern.



FOOTRINGS

All our circular barstools come standard with brass-plated footrings. You can also change them to chrome at no extra charge.

GLIDES

All our wood chairs come standard with nylon glides. For an additional charge, glides can be upgraded to felt-tip or rubber cushion.

LEG PROTECTORS

Leg protectors go a long way in conserving the finish of your chair or barstool. Available in black or opaque. NOTE: All leg protectors must be installed with a heat gun or can be factory installed.

FOOTRESTS

Each of our barstools comes with a brass footrest. You can choose from any of the finishes on the left at no extra cost. You can also upgrade to a U-Channel in lieu of a standard footrest on select models.

CASTERS

Adding front leg casters to your chair can make it more accessible. Easy to use and move. Ask your sales rep or the GAR customer service team which of our chairs can accept front casters.

OUR STANDARD NAIL FINISH IS ANTIQUÉ BRASS. ALL OTHER FINISHES ARE AVAILABLE AT NO EXTRA COST.



CASTERS



NYLON FELT TIP RUBBER CUSHION



FOOTRING

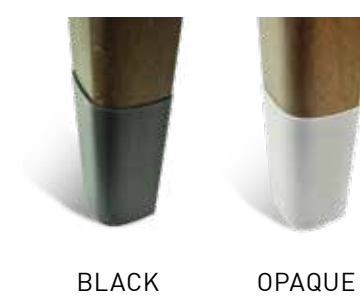

BLACK OPAQUE



BLACK
CHROME
NICKEL
BRASS
COPPER

FINISHES

LACQUER

Many of our models come with a pre-finished lacquer finish. Hard and durable, lacquer remains the choice finish material for furniture because it blends well with the natural grain and coloring of numerous wood species, and is quick to dry. It also gives a smoother and more polished surface than water-based coating systems and can be buffed to a beautiful high gloss once cured.

Lacquer finishes vary from model to model based on the country of origin of our frame builder. Due to the difficulty in maintaining lacquer finish consistencies across multiple sources, GAR Products® will not be responsible for finish variances.



LACQUER FINISHES OPTIONS VARY BY MODEL.

**MORE DURABLE AND
LONG LASTING.
HIGH ABRASION AND
STAIN RESISTANCE.
ENHANCED COLOR
CLARITY AND DEPTH.
INHERENT WATER
RESISTANCE.
ENVIRONMENTALLY
SAFE.
INSTANTANEOUS
CURE TIME.**

FINISHES

ULTRAVIOLET

Our patented ultraviolet finishing process to apply sealants and top coatings to our furniture is one of the most cutting-edge systems in the market today. The finishes used by most furniture manufacturers emit Volatile Organic Compounds (VOCs), which can escape as airborne pollutants and toxins that are harmful to humans. Our process captures 97% of these toxic VOCs by using specially formulated water-based finishes that are cured in seconds with ultraviolet energy. And being nearly 13 times cleaner than the strictest pollution control regulations in the U.S., it's better for the planet too.

Wood is a product of nature, which varies from tree to tree and piece to piece. The beauty of wood is its grain. The samples displayed are digital photographs of our UV house finishes shown on Beech wood. Actual finish samples and products may vary. Wood samples are available upon request.



**SELECT ONE OF
OUR 15 HANDSOME
FINISHES, OR OPT
FOR A COMPLETELY
CUSTOM LOOK WITH
OUR PATENTED UV
PROCESS THAT
RESISTS STAINS,
WATER AND FADING
TO LAST FOR YEARS.**



4 SEASONS OUTDOOR

OUTDOOR SEATING

RAIN OR SHINE. ON THE VERANDA OR AROUND THE DINING TABLE. OUR VERSATILE 4 SEASONS COLLECTIONS ARE WINNERS INSIDE OR OUT.





THE ISIMAR MISSION IS TO MAKE DESIGNS THAT EXPRESS THE MEDITERRANEAN LIFESTYLE.

THEIR COLLECTIONS COMMUNICATE THIS UNIQUE MIX OF CULTURE AND PASSION FOR LIFE, AIMING TO MAKE YOUR SPACE FEEL INVITING, RELAXED, SUSTAINABLE AND PLAYFUL. JOIN US, "BE MEDITERRANEAN."

INTRODUCING *iSiMAR* x GAR



THE ART OF
THE WELD AT
THE *iSiMAR*
FACTORY IN
PAMPLONA,
SPAIN.



BE MEDITERRANEAN.

iSiMAR PERFECTS THE MEDITERRANEAN PHILOSOPHY OF LIFE OUTSIDE.

Models stimulate our imagination and inspire a wide palette of colors. Their mission is to make designs that express the Mediterranean lifestyle and culture. Furniture must have passion for life. The ultimate goal is to create a space that feels inviting, relaxed and playful. Ultimately, we should all be happy.

iSiMAR origins was making galvanized and aluminum rods for their local market. In 2010 they were catapulted into designing furniture and re-inventing their own identity. Being proud to keep alive the spirit of their founders while using noble and recyclable materials (galvanized steel rods and aluminum) for fabrication of their furniture. They show the same dedication to giving life to the outside world and transmitting their Mediterranean essence as GAR does with their indoor furniture. That means appreciating the value of small moments and

enjoying the company of family and friends, moments of joy and fun.

Through innovation and know how, *iSiMAR* has continuously reinvented themselves by changing their product line to reflect market needs. We think this runs parallel to our own story.

Today they concentrate on metal furniture inspired by the Mediterranean sea. *iSiMAR* references the smells, the taste and especially the sun and the sea. The product is suitable for the commercial market inside and outside as they use galvanized steel and aluminum. *iSiMAR* truly cares about the environment by using only recycled and recyclable materials. They instituted a minimum scrap policy and 100% scrap management. The final product is resistant to the water, resistant to ultraviolet beams, and requires low maintenance.

BE MEDITERRANEAN.

PREMIUM SEATS. ECONOMY FARES.



iSiMAR x GAR PRODUCTS

(PNA) PAMPLOMA TO
(EWR) NEWARK NON-STOP



BOLONIA ARMCHAIR |

THE BOLONIA COLLECTION

GALVANIZED STEEL

FEATURES

- Suitable for Indoor or Outdoor Use
- Ready to Ship in Cream or Black
- Available in 28 additional finishes by Special Order
- Optional Seat Cushion Available



BOLONIA	
SIDE CHAIR	
20 ³ / ₄ "W 20 ³ / ₄ "D 29 ¹ / ₂ "H 18 ¹ / ₂ "SH	



BOLONIA	
ARMCHAIR	
22"W 20 ³ / ₄ "D 29 ¹ / ₂ "H 17"SH 28 ³ / ₄ "AH	



BOLONIA	
BARSTOOL	
22"W 21 ¹ / ₄ "D 41 ³ / ₄ "H 29"SH 39 ³ / ₄ "AH	

THE BOLONIA COLLECTION

GALVANIZED STEEL

Suitable for indoor or outdoor use. Available in 30 finish colors:

IBIZA WHITE	CREAM	CITRIC YELLOW	NATURAL HONEY	GERANIUM RED	TOMATO RED	RED WINE	PASTEL PINK	BOUGAINVILLEA PURPLE	PLAIN BLUE	ULTRA-MARINE BLUE	AGATA BLUE	TURQUOISE BLUE	PASTEL GREEN	PISTACHIO
PALE GREEN	KHAKI GREEN	EMERALD, GREEN	PINE GREEN	ARCILLA CLAY	BROWN CHOCOLATE	TAUPE GREY	SAND BEIGE	LIGHT GREY	STONE GREY	BLACK	NIGHT BLACK	BRONZE	MANGANESE	INDUSTRIAL

THE BOLONIA COLLECTION

GALVANIZED STEEL

Suitable for indoor or outdoor use. Available in 30 finish colors:

IBIZA WHITE	CREAM	CITRIC YELLOW	NATURAL HONEY	GERANIUM RED	TOMATO RED	RED WINE	PASTEL PINK	BOUGAINVILLEA PURPLE	PLAIN BLUE	ULTRA-MARINE BLUE	AGATA BLUE	TURQUOISE BLUE	PASTEL GREEN	PISTACHIO
PALE GREEN	KHAKI GREEN	EMERALD, GREEN	PINE GREEN	ARCILLA CLAY	BROWN CHOCOLATE	TAUPE GREY	SAND BEIGE	LIGHT GREY	STONE GREY	BLACK	NIGHT BLACK	BRONZE	MANGANESE	INDUSTRIAL



BOLONIA		SPECIAL ORDER
LOUNGE ARMCHAIR		
26"W 23 ¹ / ₄ "D 29 ¹ / ₂ "H 16 ¹ / ₂ "SH 28 ³ / ₄ "AH		

Optional Seat Cushion Available.

BOLONIA	SPECIAL ORDER
FOOTREST	
31 ¹ / ₂ "W 26"D 17 ³ / ₄ "H	



BOLONIA	SPECIAL ORDER
SOFA	
71 ¹ / ₄ "W 37"D 30"H 13"SH 26 ¹ / ₄ "AH	

Standard with seat cushion and two loose back cushions.



PALAMOS SIDE CHAIR |

THE PALAMOS COLLECTION

GALVANIZED STEEL

FEATURES

- Suitable for Indoor or Outdoor Use
- Ready to Ship in Cream or Black
- Available in 28 additional finishes by Special Order
- Optional Seat Cushion Available



PALAMOS	
SIDE CHAIR	
19 ³ / ₄ "W 19 ¹ / ₄ "D 31 ¹ / ₂ "H 18 ³ / ₄ "SH	



PALAMOS
ARMCHAIR
19 ³ / ₄ "W 19 ¹ / ₄ "D 31 ¹ / ₂ "H 18 ³ / ₄ "SH 27 ¹ / ₄ "AH



PALAMOS
BARSTOOL
17 ¹ / ₄ "W 19"D 35"H 30"SH



OLIVO ARMCHAIR |

THE OLIVO COLLECTION

GALVANIZED STEEL

FEATURES

- Suitable for Indoor or Outdoor Use
- Ready to Ship in Cream or Black
- Available in 28 additional finishes by Special Order
- Optional Seat Cushion Available

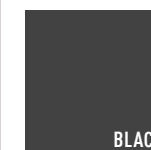

OLIVO	
ARMCHAIR	
23 ¹ / ₄ "W 19"D 30 ¹ / ₄ "H 19"SH 28 ¹ / ₄ "AH	



OLIVO		SPECIAL ORDER
LOUNGE CHAIR		
23 ¹ / ₄ "W 31"D 29 ¹ / ₄ "H 15"SH 24 ³ / ₄ "AH		

Optional Seat Cushion Available.
Available in 30 Finish Colors



OLIVO
BARSTOOL
20"W 22"D 42"H 30"SH 40"AH



PORTOFINO BARSTOOL |

THE PORTOFINO COLLECTION

GALVANIZED STEEL

FEATURES

- Suitable for Indoor or Outdoor Use
- Ready to Ship in Cream or Black
- Available in 28 additional finishes by Special Order
- Optional Seat Cushion Available



PORTOFINO	
SIDE CHAIR	
19 ³ / ₄ "W 19 ¹ / ₄ "D 31 ¹ / ₂ "H 18 ³ / ₄ "SH	



PORTOFINO	
ARMCHAIR	
19 ³ / ₄ "W 19 ¹ / ₄ "D 31 ¹ / ₂ "H 18 ³ / ₄ "SH 27 ¹ / ₄ "AH	



PORTOFINO	
BARSTOOL	
17 ¹ / ₄ "W 15 ³ / ₄ "D 35"H 30"SH	



PORTOFINO	SPECIAL ORDER
SIDE TABLE	
19 ³ / ₄ "W 19 ³ / ₄ "D 19 ³ / ₄ "H	

Base measures 20" x 22"
Available in 30 Finish Colors



THE SOUTH SEAS COLLECTION

IF THESE ROPES CAN SURVIVE
THE SOUTH CHINA SEA, THEY
CAN HANDLE YOUR OUTDOOR
SEATING AREA AS WELL



THE DUNE COLLECTION



FEATURES	SIDE CHAIR		
	<ul style="list-style-type: none"> Suitable for indoor and outdoor applications Solid genuine teak frame and slats in 'Thai Teak' finish Seat available in slatted genuine teak, wicker weave or rope box weave 	<ul style="list-style-type: none"> Wicker weave constructed of a High Density Polyethylene (HDPE) Rope constructed of polypropylene and polyester Stackable 	

TEAK





DUNE	
SIDE CHAIR WITH TEAK SLAT BACK AND SEAT	
19 1/2" W 21" D 32 3/4" H 17 1/2" SH	



DUNE		
SIDE CHAIR WITH TEAK SLAT BACK AND WICKER SEAT		
19 1/2" W 21" D 32 3/4" H 17 1/2" SH		



DUNE			
SIDE CHAIR WITH TEAK SLAT BACK AND BOX WEAVE ROPE SEAT			
19 1/2" W 21" D 32 3/4" H 17 1/2" SH			

THE DUNE COLLECTION

ARMCHAIR



Solid genuine teak with seat available in slatted teak, wicker weave or rope box weave





TEAK

DUNE	
ARMCHAIR WITH TEAK SLAT BACK AND SEAT	
23 ³ / ₄ "W 21"D 32 ³ / ₄ "H 17 ¹ / ₂ "SH 26 ¹ / ₂ "AH	



DUNE		
ARMCHAIR WITH TEAK SLAT BACK AND WICKER SEAT		
23 ³ / ₄ "W 21"D 32 ³ / ₄ "H 17 ¹ / ₂ "SH 26 ¹ / ₂ "AH		

DUNE			
ARMCHAIR WITH TEAK SLAT BACK AND BOX WEAVE ROPE SEAT			
23 ³ / ₄ "W 21"D 32 ³ / ₄ "H 17 ¹ / ₂ "SH 26 ¹ / ₂ "AH			

THE DUNE COLLECTION

BARSTOOL

Solid genuine teak with seat available in slatted teak, wicker weave or rope box weave



TEAK

DUNE
BARSTOOL WITH TEAK SLAT BACK AND SEAT
21 ³ / ₄ "W 23 ¹ / ₂ "D 44 ¹ / ₂ "H 29 ¹ / ₂ "SH



DUNE	
BARSTOOL WITH TEAK SLAT BACK AND WICKER SEAT	
21 ³ / ₄ "W 23 ¹ / ₂ "D 44 ¹ / ₂ "H 29 ¹ / ₂ "SH	

DUNE		
BARSTOOL WITH TEAK SLAT BACK AND BOX WEAVE ROPE SEAT		
21 ³ / ₄ "W 23 ¹ / ₂ "D 44 ¹ / ₂ "H 29 ¹ / ₂ "SH		



CUSTOM FRAME FINISH |

THE KNOT COLLECTION

FEATURES	<ul style="list-style-type: none"> Suitable for indoor and outdoor applications Electro galvanized steel frame construction with powder coated finish Polypropylene and polyester rope box weave seat and back Stackable 	<div style="background-color: #333; color: white; padding: 2px; font-size: 8px;">CHARCOAL GREY</div>	<div style="font-size: 8px;">LATTE</div> <div style="font-size: 8px;">CHARCOAL</div> <div style="font-size: 8px;">ORANGE</div>
	<div style="background-color: #808080; color: white; padding: 2px; font-size: 8px;">OXIDE</div>	ROPE	



KNOT BARSTOOL	
24 1/2" W 23 1/2" D 42 1/2" H 29" SH	



KNOT SIDE CHAIR	
22 3/4" W 22" D 35" H 18" SH	



KNOT HALFBACK BARSTOOL	
24 1/2" W 23 1/2" D 36" H 29" SH	

OLD THAI TEAK FINISH SHOWN |



THE LURE COLLECTION

FEATURES

- Suitable for indoor and outdoor applications
- Solid genuine teak frame construction in 'Thai Teak' finish
- Polypropylene and polyester rope box weave seat and back
- Stackable

TEAK

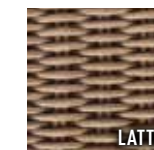
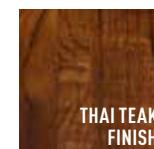

ROPE



LURE
BARSTOOL
20"W 24 ¹ / ₄ "D 43 ¹ / ₄ "H 29 ¹ / ₂ "SH



LURE	
SIDE CHAIR	
18 ³ / ₄ "W 22 ³ / ₄ "D 34"H 18 ¹ / ₄ "SH	

OLD THAI TEAK FINISH SHOWN |



THE PORT COLLECTION

FEATURES

- Suitable for indoor and outdoor applications
- Solid genuine teak frame and slats in 'Thai Teak' finish
- Sikaflex® caulk in between slats
- Stainless steel arms
- Stackable



TEAK



PORT	
SIDE CHAIR	
19 ¹ / ₄ "W 23" D 35 ¹ / ₂ " H 18"SH	



OUTDOOR TABLES X BASES

WHETHER AL FRESCO BY THE SEA,
POOLSIDE OR CITY DINING, THESE
TABLES OFFER STURDY WEATHER
RESISTANCE FOR CASUAL DINING.



MAX TOP AND BASE |

THE MAX COLLECTION

GALVANIZED STEEL

FEATURES

- Suitable for Indoor or Outdoor Use
- Ready to Ship in Cream or Black
- Available in 28 additional finishes by Special Order
- Compatible Tops
- Top and base are sold as a set



Note: Round columns only available on round bases, and square columns only available on square bases



MAX
BASE, ROUND, BAR
19 ³ / ₄ " x 19 ³ / ₄ " x 42"
Tops available in
30"



MAX
BASE, ROUND, STANDARD
19 ³ / ₄ " x 19 ³ / ₄ " x 30"
Tops available in:
30"



MAX
BASE, SQUARE, STANDARD
19 ³ / ₄ " x 19 ³ / ₄ " x 30"
Tops available in:
24" x 24" 30" x 30" 30" x 48"

Note: 30" x 48" top is ADA compliant



MAX
BASE, SQUARE, BAR
19 ³ / ₄ " x 19 ³ / ₄ " x 42"
Tops available in:
24" x 24" 30" x 30"



SANTORINI TOP AND BASE |

THE SANTORINI COLLECTION

GALVANIZED STEEL

FEATURES

- Suitable for Indoor or Outdoor Use
- Ready to Ship in Cream or Black
- Available in 28 additional finishes by Special Order
- Compatible Tops
- Top and base are sold as a set



Note: Round columns only available for this series. Square column not available.



SANTORINI
BASE, STANDARD HEIGHT
23 ¹ / ₄ " W 23 ¹ / ₄ " D 29" H
Tops available in:
24" x 24" 30" x 30" 24" Rnd 30" Rnd



SANTORINI
BASE, BAR HEIGHT
23 ¹ / ₄ " W 23 ¹ / ₄ " D 42" H
Tops available in:
24" x 24" 30" x 30" 24" Rnd 30" Rnd

THE SANTORINI COLLECTION

GALVANIZED STEEL

Suitable for indoor or outdoor use. Available with coordinating metal top in 30 finish colors. Top and base are sold as a set.

IBIZA WHITE	CREAM	CITRIC YELLOW	NATURAL HONEY	GERANIUM RED	TOMATO RED	RED WINE	PASTEL PINK	BOUGAINVILLEA PURPLE	PLAIN BLUE	ULTRA-MARINE BLUE	AGATA BLUE	TURQUOISE BLUE	PASTEL GREEN	PISTACHIO
PALE GREEN	KHAKI GREEN	EMERALD, GREEN	PINE GREEN	ARCILLA CLAY	BROWN CHOCOLATE	TAUPE GREY	SAND BEIGE	LIGHT GREY	STONE GREY	BLACK	NIGHT BLACK	BRONZE	MANGANESE	INDUSTRIAL



SANTORINI	SPECIAL ORDER
SIDE TABLE	
23 ¹ / ₄ " W 23 ¹ / ₄ " D 17 ³ / ₄ " H	
Round Tops available in: 23 ¹ / ₂ " 27 ¹ / ₂ " 31 ¹ / ₂ "	

STYLE FSS COLLECTION

FEATURES

- 304 stainless steel base
- Suitable for indoor and outdoor applications
- Durable, low maintenance material is 100% recyclable
- Available bar height

The Style FSS Collection instantly adds contemporary design to any room. These stainless steel table bases offer a combination of strength and beauty which can support a wide range of table top sizes.



STYLE FSS COLLECTION	
FSS ROUND	
Available in:	18" Dia. base spread 28 ¹ / ₂ " H
	21" Dia. base spread 28 ¹ / ₂ " H
	29 ¹ / ₂ " Dia. base spread 28 ¹ / ₂ " H
	3" column, 11 ³ / ₄ " sq. top plate



STYLE FSS COLLECTION	
FSS SQUARE	
Available in:	18" x 18" base spread 28 ¹ / ₂ " H
	21" x 21" base spread 28 ¹ / ₂ " H
	3" column, 11 ³ / ₄ " sq. top plate



STYLE FSS COLLECTION	
FSS DOUBLE RECTANGLE	
	27 ¹ / ₂ " W 18" D 28 ¹ / ₂ " H
	[2] 3" column, 11 ³ / ₄ " sq. top plate



STYLE FSS COLLECTION	
FSS TRIPLE ROUND	
	29 ¹ / ₂ " Dia. base spread 28 ¹ / ₂ " H
	[3] 3" column, 11 ³ / ₄ " sq. top plate

ECO LINE ACRYLIC TABLE TOPS

FEATURES	<ul style="list-style-type: none"> • Appropriate for indoor and outdoor applications • 3/4" thick full marine grade plywood substrate • Hygienic, non-porous surface, UV stable and stain resistant • Standard with ECO Line Edge • 1 1/4" edge thickness 	ECO LINE ACRYLIC SIZES		
		20" x 24" 20" x 27" 24" x 24" 24" x 32"	24" x 36" 30" x 30" 30" x 42" 30" x 48"	36" x 36" 36" x 48" 36" x 72" 42" x 24"
	ECO LINE ACRYLIC ROUND SIZES			
		18" diameter 24" diameter	28" diameter 30" diameter	36" diameter 42" diameter

The ECO Line delivers all the beauty and durability of our molded table top line at a significantly lower price point. A combination of an ECO Line edge with light weight construction provides a sleek and

contemporary look. They are constructed with a full built-in mounting plate and are suitable for both indoor and outdoor use. The ECO Line is a perfect coalition of quality and price.

FOB NY

NOTE: Series I with the exception of Black Quarry are the only eco-line acrylic table tops that should be used in full sun.

ECO LINE SERIES I

Black Granite	Nocturnal	Brown Granite	Brownstone	Butter Pecan
Cocoa	Diamond Dust	Dove Grey	Golden Oak	Sueillia Green
Wheat	Gravel	Harvest Sand	Hazel Nut	Moon Dust
Mahogany Rox	Heather Green	Kauai Purple	Lynne Star	Oahu Green

ECO LINE ACRYLIC TABLE TOPS

ECO LINE SERIES I – continued

Pistachio	Nutmeg	Pebble Rox	Pezza	White Quartz
Riverstone	Saffron	Sage Brush	Sandy Canyon	Sandy Rox
Stellar Blue				

ECO LINE SERIES II

Rockie	Red Granite	Oat	Khaki	Grey Granite
Green Granite	Gold Dust	Glacier	Blue Granite	

SOLID ACRYLIC TABLE TOPS

FEATURES

- Appropriate for indoor and outdoor applications
- 3/4" thick full marine grade plywood substrate
- Hygienic, non-porous surface, UV stable and stain resistant
- Standard with waterfall profile edge



SOLID ACRYLIC SIZES

20" x 24"	24" x 36"	36" x 36"
20" x 27"	30" x 30"	36" x 48"
24" x 24"	30" x 42"	36" x 72"
24" x 32"	30" x 48"	42" x 24"

SOLID ACRYLIC ROUND SIZES

18" diameter	28" diameter	36" diameter
24" diameter	30" diameter	42" diameter

Our solid acrylic table tops offer a unique look with exceptional durability. This non-porous surface is hygienic, UV stable and stain resistant for easy cleaning. GAR's solid acrylic tops are available in

over fifty color options, have a waterfall edge and a full subsurface durable enough for outdoor applications. FOB NY

STANDARD OPAQUE

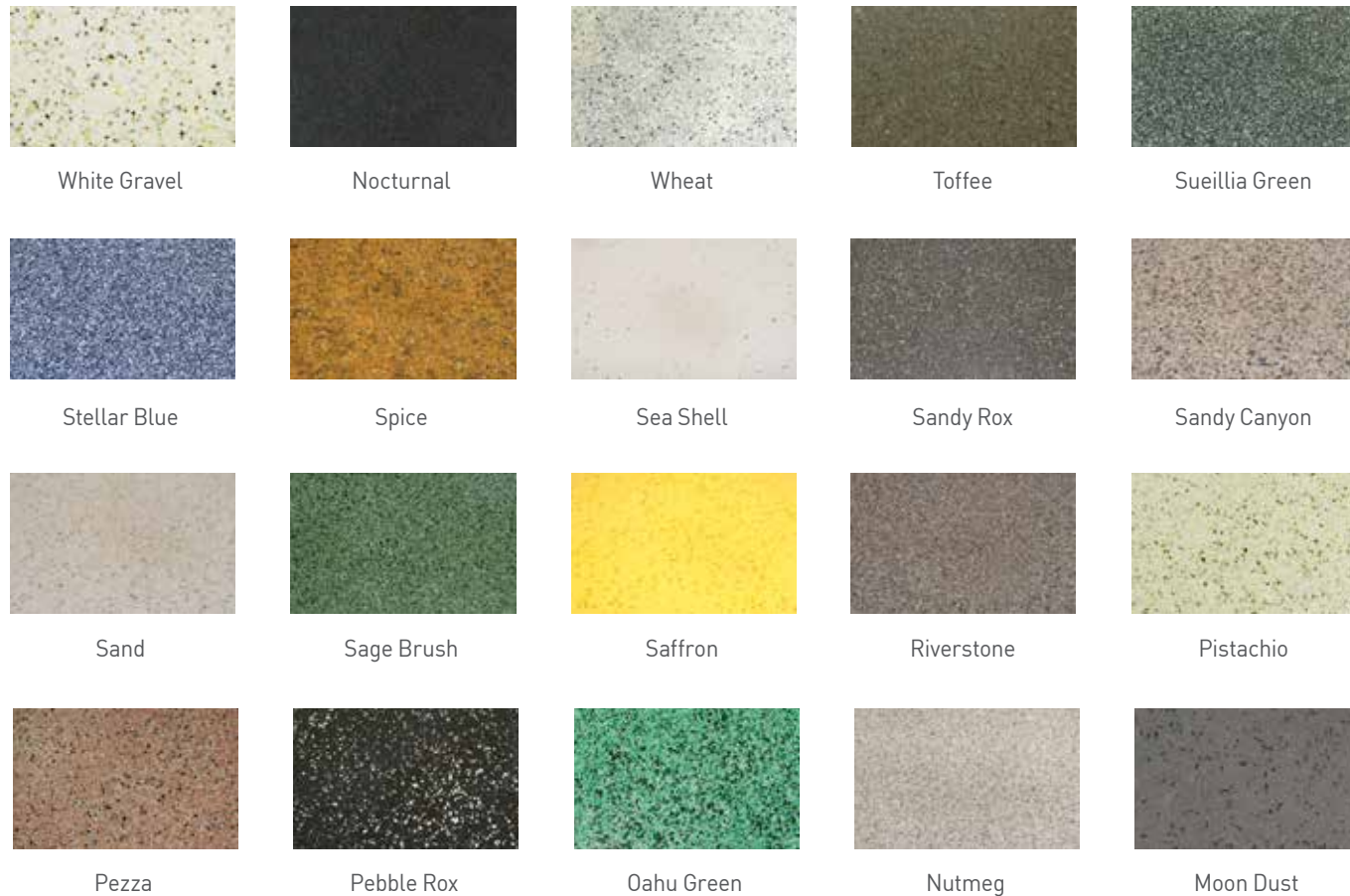

SOLID ACRYLIC TABLE TOPS

STANDARD OPAQUE - continued



TRANSLUCENT

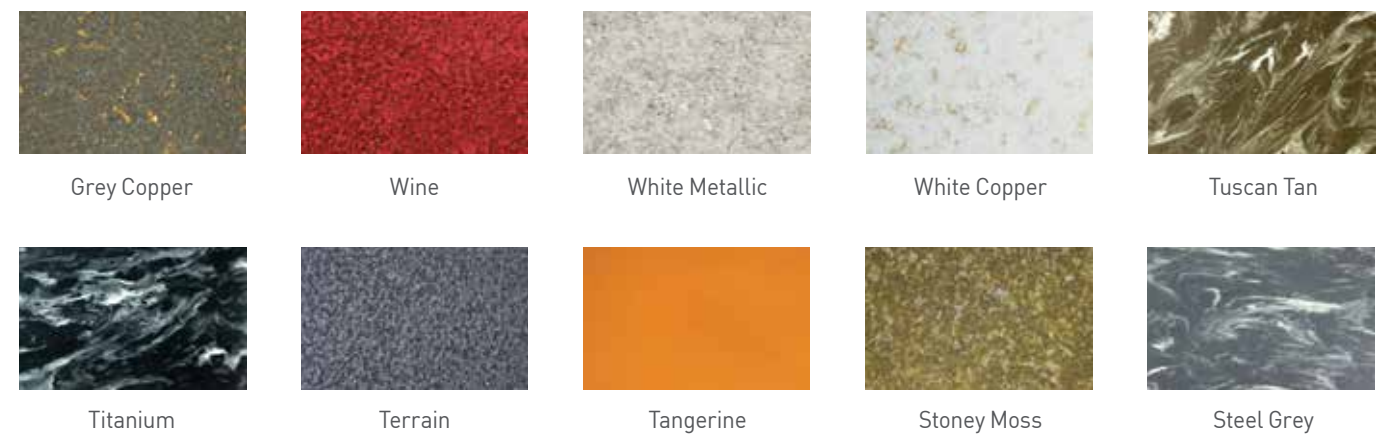

SOLID ACRYLIC TABLE TOPS

TRANSLUCENT – continued



SOLID ACRYLIC TABLE TOPS

TRANSLUCENT – continued

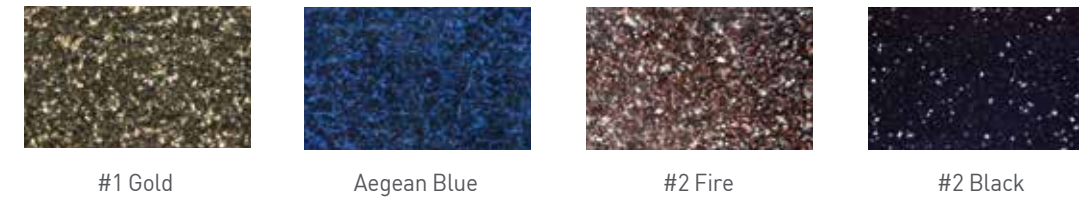

PREMIUM GEM



SPECIAL ORDER

UNIQUE AND DURABLE FOR THAT SPECIAL
AREA WHETHER INDOORS OR OUT







LAGARTO CURVED SOFA |

THE LAGARTO COLLECTION

GALVANIZED STEEL

Suitable for indoor or outdoor use. Available in 30 finish colors:

IBIZA WHITE	CREAM	CITRIC YELLOW	NATURAL HONEY	GERANIUM RED	TOMATO RED	RED WINE	PASTEL PINK	BOUGAINVILLEA PURPLE	PLAIN BLUE	ULTRA-MARINE BLUE	AGATA BLUE	TURQUOISE BLUE	PASTEL GREEN	PISTACHIO
PALE GREEN	KHAKI GREEN	EMERALD GREEN	PINE GREEN	ARCILLA CLAY	BROWN CHOCOLATE	TAUPE GREY	SAND BEIGE	LIGHT GREY	STONE GREY	BLACK	NIGHT BLACK	BRONZE	MANGANESE	INDUSTRIAL

LAGARTO	SPECIAL ORDER
SOFA	
41"W 33 ³ / ₄ "D 29"H 15 ¹ / ₄ "SH 27 ¹ / ₂ "AH	

Standard with seat cushion and two loose back cushions



LAGARTO	SPECIAL ORDER
LOUNGE CHAIR	
27"W 27"D 29"H 15 ¹ / ₄ "SH 27"AH	

Standard with seat cushion and one loose back cushions



THE LAGARTO COLLECTION

GALVANIZED STEEL

Suitable for indoor or outdoor use. Available in 30 finish colors. Standard with seat and back cushion.

IBIZA WHITE	CREAM	CITRIC YELLOW	NATURAL HONEY	GERANIUM RED	TOMATO RED	RED WINE	PASTEL PINK	BOUGAINVILLEA PURPLE	PLAIN BLUE	ULTRA-MARINE BLUE	AGATA BLUE	TURQUOISE BLUE	PASTEL GREEN	PISTACHIO
PALE GREEN	KHAKI GREEN	EMERALD GREEN	PINE GREEN	ARCILLA CLAY	BROWN CHOCOLATE	TAUPE GREY	SAND BEIGE	LIGHT GREY	STONE GREY	BLACK	NIGHT BLACK	BRONZE	MANGANESE	INDUSTRIAL



LAGARTO	SPECIAL ORDER
CURVED SOFA	
51"W 28 ¹ / ₄ "D 26 ³ / ₄ "H 14"SH	



LAGARTO	SPECIAL ORDER
STRAIGHT SOFA	
31 ¹ / ₂ "W 28 ¹ / ₄ "D 26 ³ / ₄ "H 14"SH	



LAGARTO	SPECIAL ORDER
OTTOMAN	
28"W 21 ¹ / ₄ "D 13 ¹ / ₂ "H	

SUGGESTED LAYOUTS

Note: Dimensions are approximate.

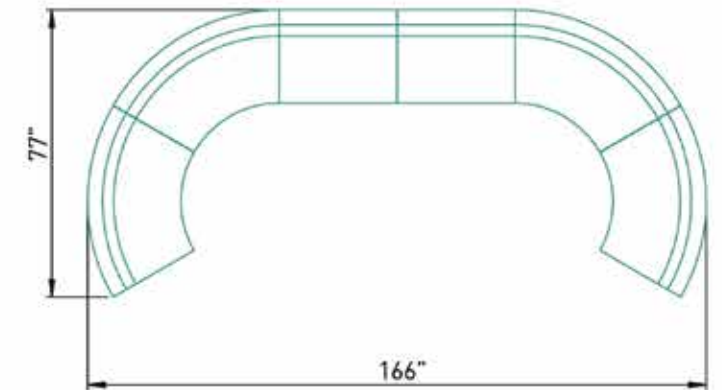
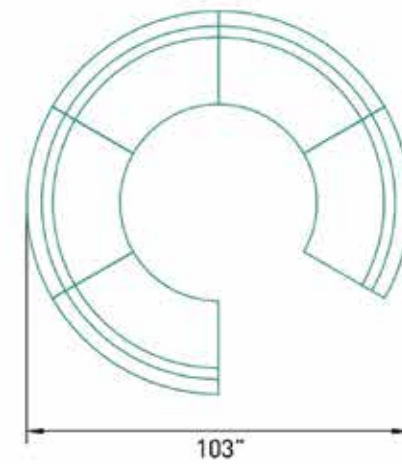
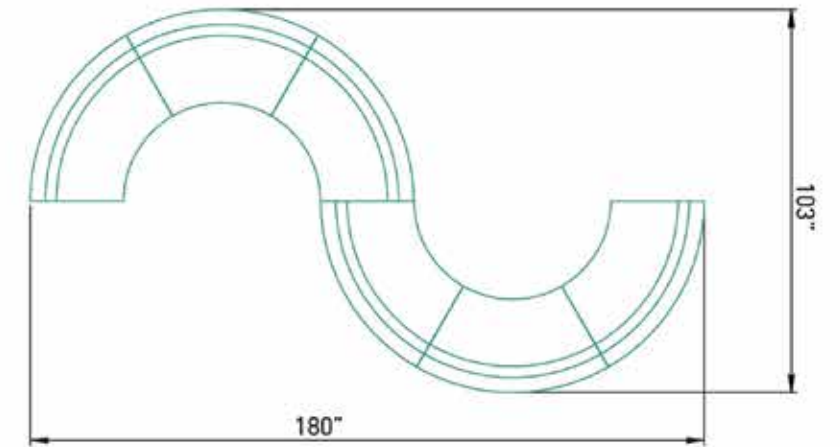
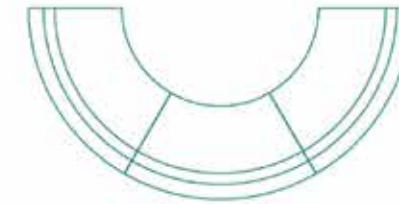
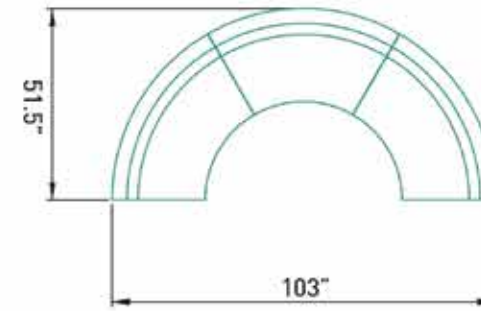



LAGARTO STOOL AND DINING TABLE |

THE LAGARTO COLLECTION

GALVANIZED STEEL

Suitable for indoor or outdoor use. Available in 30 finish colors. Standard with seat cushion.

IBIZA WHITE	CREAM	CITRIC YELLOW	NATURAL HONEY	GERANIUM RED	TOMATO RED	RED WINE	PASTEL PINK	BOUGAINVILLEA PURPLE	PLAIN BLUE	ULTRA-MARINE BLUE	AGATA BLUE	TURQUOISE BLUE	PASTEL GREEN	PISTACHIO
PALE GREEN	KHAKI GREEN	EMERALD GREEN	PINE GREEN	ARCILLA CLAY	BROWN CHOCOLATE	TAUPE GREY	SAND BEIGE	LIGHT GREY	STONE GREY	BLACK	NIGHT BLACK	BRONZE	MANGANESE	INDUSTRIAL



LAGARTO
BARSTOOL
16¹/₂"W | 16¹/₂"D | 30³/₄"H | 30³/₄"SH

SPECIAL ORDER



LAGARTO
STOOL
14¹/₂"W | 14¹/₂"D | 19³/₄"H | 19³/₄"SH

SPECIAL ORDER

THE LAGARTO COLLECTION

GALVANIZED STEEL

Suitable for indoor or outdoor use. Available with coordinating metal top in 30 finish colors.

IBIZA WHITE	CREAM	CITRIC YELLOW	NATURAL HONEY	GERANIUM RED	TOMATO RED	RED WINE	PASTEL PINK	BOUGAINVILLEA PURPLE	PLAIN BLUE	ULTRA-MARINE BLUE	AGATA BLUE	TURQUOISE BLUE	PASTEL GREEN	PISTACHIO
PALE GREEN	KHAKI GREEN	EMERALD, GREEN	PINE GREEN	ARCILLA CLAY	BROWN CHOCOLATE	TAUPE GREY	SAND BEIGE	LIGHT GREY	STONE GREY	BLACK	NIGHT BLACK	BRONZE	MANGANESE	INDUSTRIAL



LAGARTO	SPECIAL ORDER
DINING TABLE	
16 ¹ / ₂ "W 16 ¹ / ₂ "D 29 ³ / ₄ "H	
Tops available in:	
23 ¹ / ₂ " 27 ¹ / ₂ " 31 ¹ / ₂ " 35 ¹ / ₂ " 43 ¹ / ₄ "	

THE LAGARTO COLLECTION

GALVANIZED STEEL

Suitable for indoor or outdoor use. Available with coordinating metal top in 30 finish colors.

IBIZA WHITE	CREAM	CITRIC YELLOW	NATURAL HONEY	GERANIUM RED	TOMATO RED	RED WINE	PASTEL PINK	BOUGAINVILLEA PURPLE	PLAIN BLUE	ULTRA-MARINE BLUE	AGATA BLUE	TURQUOISE BLUE	PASTEL GREEN	PISTACHIO
PALE GREEN	KHAKI GREEN	EMERALD, GREEN	PINE GREEN	ARCILLA CLAY	BROWN CHOCOLATE	TAUPE GREY	SAND BEIGE	LIGHT GREY	STONE GREY	BLACK	NIGHT BLACK	BRONZE	MANGANESE	INDUSTRIAL



LAGARTO	SPECIAL ORDER
SIDE TABLE	
16 ¹ / ₂ "W 16 ¹ / ₂ "D 17 ³ / ₄ "H	
Tops available in:	
23 ¹ / ₂ " 27 ¹ / ₂ " 31 ¹ / ₂ " 35 ¹ / ₂ " 43 ¹ / ₄ "	



SANREMO ALUMINUM ARMCHAIR |

THE SANREMO COLLECTION

POWDER COATED ALUMINUM

Suitable for indoor or outdoor use. Available in 30 finish colors. Optional seat cushion available.

IBIZA WHITE	CREAM	CITRIC YELLOW	NATURAL HONEY	GERANIUM RED	TOMATO RED	RED WINE	PASTEL PINK	BOUGAINVILLEA PURPLE	PLAIN BLUE	ULTRA-MARINE BLUE	AGATA BLUE	TURQUOISE BLUE	PASTEL GREEN	PISTACHIO
PALE GREEN	KHAKI GREEN	EMERALD GREEN	PINE GREEN	ARCILLA CLAY	BROWN CHOCOLATE	TAUPE GREY	SAND BEIGE	LIGHT GREY	STONE GREY	BLACK	NIGHT BLACK	BRONZE	MANGANESE	INDUSTRIAL



SANREMO	 SPECIAL ORDER
ARMCHAIR	
20"W 21"1/4"D 29"1/2"H 17"1/4"SH 28"1/4"AH	



THE CRETE COLLECTION

GALVANIZED STEEL Suitable for indoor or outdoor use. ADA available upon request. Available in 30 finish colors.

IBIZA WHITE	CREAM	CITRIC YELLOW	NATURAL HONEY	GERANIUM RED	TOMATO RED	RED WINE	PASTEL PINK	BOUGAINVILLEA PURPLE	PLAIN BLUE	ULTRA-MARINE BLUE	AGATA BLUE	TURQUOISE BLUE	PASTEL GREEN	PISTACHIO
PALE GREEN	KHAKI GREEN	EMERALD GREEN	PINE GREEN	ARCILLA CLAY	BROWN CHOCOLATE	TAUPE GREY	SAND BEIGE	LIGHT GREY	STONE GREY	BLACK	NIGHT BLACK	BRONZE	MANGANESE	INDUSTRIAL



CRETE	SPECIAL ORDER
SIDE TABLE	
15 ³ / ₄ "W 15 ³ / ₄ "D 19 ³ / ₄ "H	
Tops available in 19 ³ / ₄ " 23 ¹ / ₂ "	



CAPRI COLLECTION TABLE AND BASE |

THE CAPRI COLLECTION

GALVANIZED STEEL Suitable for indoor or outdoor use. Available with coordinating metal top in 30 finish colors.

IBIZA WHITE	CREAM	CITRIC YELLOW	NATURAL HONEY	GERANIUM RED	TOMATO RED	RED WINE	PASTEL PINK	BOUGAINVILLEA PURPLE	PLAIN BLUE	ULTRA-MARINE BLUE	AGATA BLUE	TURQUOISE BLUE	PASTEL GREEN	PISTACHIO
PALE GREEN	KHAKI GREEN	EMERALD, GREEN	PINE GREEN	ARCILLA CLAY	BROWN CHOCOLATE	TAUPE GREY	SAND BEIGE	LIGHT GREY	STONE GREY	BLACK	NIGHT BLACK	BRONZE	MANGANESE	INDUSTRIAL



CAPRI	SPECIAL ORDER
TABLE AND BASE, DINING HEIGHT	
24"W 24"D 29"H	
Tops available in:	
23 ¹ / ₂ " 27 ¹ / ₂ " 31 ¹ / ₂ " 35 ¹ / ₂ " 23 ¹ / ₂ " x 23 ¹ / ₂ " 31 ¹ / ₂ " x 31 ¹ / ₂ " 35 ¹ / ₂ " x 35 ¹ / ₂ " 43 ¹ / ₄ " x 27 ¹ / ₂ " 47 ¹ / ₄ " x 31 ¹ / ₂ "	



CAPRI COLLECTION BAR HEIGHT TABLE AND BASE |

THE CAPRI COLLECTION

GALVANIZED STEEL Suitable for indoor or outdoor use. Available with coordinating metal top in 30 finish colors.

IBIZA WHITE	CREAM	CITRIC YELLOW	NATURAL HONEY	GERANIUM RED	TOMATO RED	RED WINE	PASTEL PINK	BOUGAINVILLEA PURPLE	PLAIN BLUE	ULTRA-MARINE BLUE	AGATA BLUE	TURQUOISE BLUE	PASTEL GREEN	PISTACHIO
PALE GREEN	KHAKI GREEN	EMERALD GREEN	PINE GREEN	ARCILLA CLAY	BROWN CHOCOLATE	TAUPE GREY	SAND BEIGE	LIGHT GREY	STONE GREY	BLACK	NIGHT BLACK	BRONZE	MANGANESE	INDUSTRIAL



CAPRI	SPECIAL ORDER
TABLE AND BASE, COCKTAIL HEIGHT	
20 ^{3/4} "W 20 ^{3/4} "D 19 ^{3/4} "H	
Tops available in: 23 ^{1/2} " 27 ^{1/2} " 31 ^{1/2} " 35 ^{1/2} " 23 ^{1/2} "x 23 ^{1/2} " 31 ^{1/2} "x 31 ^{1/2} " 35 ^{1/2} "x 35 ^{1/2} "	



CAPRI	SPECIAL ORDER
TABLE AND BASE, BAR HEIGHT	
26"W 26"D 43 ^{3/4} "H	
Tops available in: 23 ^{1/2} " 27 ^{1/2} " 31 ^{1/2} " 35 ^{1/2} " 23 ^{1/2} "x 23 ^{1/2} " 31 ^{1/2} "x 31 ^{1/2} "	



THE VALETTA COLLECTION

POWDER COATED ALUMINUM

Suitable for indoor or outdoor use. Optional seat cushion available. Available in 30 finish colors.

IBIZA WHITE	CREAM	CITRIC YELLOW	NATURAL HONEY	GERANIUM RED	TOMATO RED	RED WINE	PASTEL PINK	BOUGAINVILLEA PURPLE	PLAIN BLUE	ULTRA-MARINE BLUE	AGATA BLUE	TURQUOISE BLUE	PASTEL GREEN	PISTACHIO
PALE GREEN	KHAKI GREEN	EMERALD GREEN	PINE GREEN	ARCILLA CLAY	BROWN CHOCOLATE	TAUPE GREY	SAND BEIGE	LIGHT GREY	STONE GREY	BLACK	NIGHT BLACK	BRONZE	MANGANESE	INDUSTRIAL



VALETTA	SPECIAL ORDER
SIDE CHAIR	
20 ¹ / ₂ " W 19 ³ / ₄ " D 32" H 17 ¹ / ₂ " SH	



VALETTA	SPECIAL ORDER
ARMCHAIR	
22 ¹ / ₂ " W 19 ³ / ₄ " D 32" H 17 ¹ / ₂ " SH 26" AH	

VALETTA ARMCHAIR |

THE VALETTA COLLECTION

POWDER COATED ALUMINUM

Suitable for indoor or outdoor use. Optional seat cushion available. Available in 30 finish colors

IBIZA WHITE	CREAM	CITRIC YELLOW	NATURAL HONEY	GERANIUM RED	TOMATO RED	RED WINE	PASTEL PINK	BOUGAINVILLEA PURPLE	PLAIN BLUE	ULTRA-MARINE BLUE	AGATA BLUE	TURQUOISE BLUE	PASTEL GREEN	PISTACHIO
PALE GREEN	KHAKI GREEN	EMERALD GREEN	PINE GREEN	ARCILLA CLAY	BROWN CHOCOLATE	TAUPE GREY	SAND BEIGE	LIGHT GREY	STONE GREY	BLACK	NIGHT BLACK	BRONZE	MANGANESE	INDUSTRIAL



VALETTA	SPECIAL ORDER
LOUNGE CHAIR	
22 ¹ / ₂ "W 30"D 30 ³ / ₄ "H 13 ³ / ₄ "SH 22"AH	



VALETTA	SPECIAL ORDER
BARSTOOL	
20"W 17 ¹ / ₄ "D 40 ³ / ₄ "H 31"SH	

THE VALETTA COLLECTION

POWDER COATED ALUMINUM

Suitable for indoor or outdoor use. Frame available in 30 finish colors:

IBIZA WHITE	CREAM	CITRIC YELLOW	NATURAL HONEY	GERANIUM RED	TOMATO RED	RED WINE	PASTEL PINK	BOUGAINVILLEA PURPLE	PLAIN BLUE	ULTRA-MARINE BLUE	AGATA BLUE	TURQUOISE BLUE	PASTEL GREEN	PISTACHIO
PALE GREEN	KHAKI GREEN	EMERALD GREEN	PINE GREEN	ARCILLA CLAY	BROWN CHOCOLATE	TAUPE GREY	SAND BEIGE	LIGHT GREY	STONE GREY	BLACK	NIGHT BLACK	BRONZE	MANGANESE	INDUSTRIAL



VALETTA	SPECIAL ORDER
SUN LOUNGER	
24 ³ / ₄ "W 72 ³ / ₄ "D 33 ¹ / ₂ "H 11 ³ / ₄ "SH	

Cover available in various colors, please inquire.



SEVILLA SIDE CHAIR |

THE SEVILLA COLLECTION

GALVANIZED STEEL Suitable for indoor or outdoor use. Optional seat cushion available. Available in 30 finish colors.

IBIZA WHITE	CREAM	CITRIC YELLOW	NATURAL HONEY	GERANIUM RED	TOMATO RED	RED WINE	PASTEL PINK	BOUGAINVILLEA PURPLE	PLAIN BLUE	ULTRA-MARINE BLUE	AGATA BLUE	TURQUOISE BLUE	PASTEL GREEN	PISTACHIO
PALE GREEN	KHAKI GREEN	EMERALD GREEN	PINE GREEN	ARCILLA CLAY	BROWN CHOCOLATE	TAUPE GREY	SAND BEIGE	LIGHT GREY	STONE GREY	BLACK	NIGHT BLACK	BRONZE	MANGANESE	INDUSTRIAL



SEVILLA	 SPECIAL ORDER
SIDE CHAIR	
19 1/2"W 23"D 31 1/2"H 17 1/2"SH	



SEVILLA	 SPECIAL ORDER
ARMCHAIR	
20 3/4"W 23"D 31 1/2"H 17 1/2"SH 25 3/4"AH	



SEVILLA	 SPECIAL ORDER
BARSTOOL	
20"W 17 1/4"D 40 3/4"H 31"SH	



THE SARDINA COLLECTION

POWDER COATED ALUMINUM

Suitable for indoor or outdoor use. Optional seat cushion available. Available in 30 finish colors.

IBIZA WHITE	CREAM	CITRIC YELLOW	NATURAL HONEY	GERANIUM RED	TOMATO RED	RED WINE	PASTEL PINK	BOUGAINVILLEA PURPLE	PLAIN BLUE	ULTRA-MARINE BLUE	AGATA BLUE	TURQUOISE BLUE	PASTEL GREEN	PISTACHIO
PALE GREEN	KHAKI GREEN	EMERALD GREEN	PINE GREEN	ARCILLA CLAY	BROWN CHOCOLATE	TAUPE GREY	SAND BEIGE	LIGHT GREY	STONE GREY	BLACK	NIGHT BLACK	BRONZE	MANGANESE	INDUSTRIAL



SARDINIA	
SIDE CHAIR	
20 ¹ / ₂ " W 19 ³ / ₄ " D 32" H 17 ¹ / ₂ " SH	



SARDINIA	
ARMCHAIR	
22 ¹ / ₂ " W 19 ³ / ₄ " D 32" H 17 ¹ / ₂ " SH 28 ³ / ₄ " AH	



SARDINIA	
BARSTOOL	
20" W 17 ¹ / ₄ " D 40 ³ / ₄ " H 31" SH	



OUTDOOR TEXTILES

TEXTILES

SUNBRELLA® I CANVAS



TEXTILES

SUNBRELLA® I CANVAS – continued



- Contents: 100% solution dyed acrylic
- Width: 54 inches
- Flammability: Meets California Technical Bulletin #117 Sec E (CS-191-53)
- Classification: 1 Normal flammability

- Solution dyed to give excellent fade and weather resistance
- Made from 100% dyed acrylic fiber which is thermoplastic. Do not subject to excessive heat. When Sunbrella® fabric is stored, it should be cleaned, allowed to dry and stored in a dry, well ventilated area.

- Please note that all colors pictured in product images, finishes and materials may vary from their actual color

TEXTILES

SUNBRELLA® | DUPIONE



Pearl Sand Dove Latte Walnut



Stone Oak Bamboo Nectarine Cornsilk



Paradise Peridot Aloe Laurel Celeste



Deep Sea Galaxy Crimson Henna Papaya

TEXTILES

SUNBRELLA® | LINEN



Antique Beige Canvas Champagne Chili Natural



Pampas Sesame Silver Stone Straw



Taupe

- Contents: 100% solution dyed acrylic
- Width: 54 inches
- Flammability: Meets California Technical Bulletin #117 Sec E (CS-191-53)
- Classification: 1 Normal flammability

- Solution dyed to give excellent fade and weather resistance
- Made from 100% dyed acrylic fiber which is thermoplastic. Do not subject to excessive heat. When Sunbrella® fabric is stored, it should be cleaned, allowed to dry and stored in a dry, well ventilated area.

- Please note that all colors pictured in product images, finishes and materials may vary from their actual color

CARE AND MAINTENANCE



TEAK

All of our teak is naturally grown and will have varying color and grain in each piece. Proper care and cleaning will enhance and maintain the natural beauty of the wood. Left by itself, the teak will develop a silver-gray patina. For general cleaning when removing dirt, moss and surface stains, use a sponge or a soft cloth and clean with a solution of, 2 ounces of dishwashing soap with, 8 cups of lukewarm water. Make sure to rinse completely with clean water and allow time to air dry before use. For further care and protection of your teak furniture use Golden Care protection products. Please note that retreatment will be required as all protective finishes are not permanent.

METAL CARE

In general our metal furniture can be cleaned with clean water or non-detergent soap.

Abrasive sponges, detergent, abrasive powders should not be used to clean our metal furniture.

For dirt, crayons, black scuff marks or any similar marks that are more heavily ingrained, a window-cleaning product that contains alcohol or specific product such as star brite Multi-Purpose Cleaner should be used.



CARE AND MAINTENANCE

ROPE WEAVE

We recommend to simply wash it with mild soap and water solution, rinse and allow to dry thoroughly.



STAINLESS STEEL

Scratches in stainless can be buffed out with Scotch-Brite™ pads or very fine grit sand paper (steel wool is not recommended due to the mild steel fibers contaminating the stainless surface, therefore leaving rust colored stains). It is also recommended that the surface of the grain is followed in the same direction when buffing out scratches. Stainless, although very resistant to corrosive environments, does require periodic care and maintenance. Cleaning is necessary on all grades of stainless to prevent corrosive particles from gathering in the grain of the stainless surface. This results in a rust colored staining. Weekly cleaning with a good stainless cleaner will keep the surface free from corrosive particles. In environments where there is salt, chlorine or air pollution present, a weekly cleaning with water and liquid detergent followed by drying will keep the stainless surface free from contamination. If staining has occurred, the surface can be cleaned with a nonabrasive kitchen cream cleanser and a light coat of a good quality protective spray such as Fluid Film® can be applied.



CARE AND MAINTENANCE



SOLID SURFACE ACRYLIC

GENERAL CLEANING

All table tops and fabricated sheet goods can be cleaned by using soap and water. Apply soap and water with a sponge or damp cloth, then towel dry to eliminate water spots.

PROTECTING THE SURFACE

All table tops and fabricated sheet goods are resistant to most household cleaners. Table tops and sheet goods should NOT be exposed to chemicals such as paint remover, metal cleaner, oven cleaner, acetone, nail polish remover, abrasive cleaner, and acid drain cleaner. Protect the finish with acrylic polish such as Countertop Magic® or furniture polish.

All surfaces should NOT be exposed to direct heat. The use of insulated mats underneath hot objects will avoid damage to your surface.



CARE AND MAINTENANCE

SUNBRELLA®

CONTENTS: 100% solution dyed acrylic

WEIGHT: Approximately 8.0 ounces per sq. yard

WIDTH: 54 inches

FLAMMABILITY: Meets California Technical Bulletin #117 Sec. E (CS-191-53)

CLASSIFICATION: 1 Normal flammability

ADDITIONAL INFORMATION: Solution dyed to give excellent fade and weather resistance. Made from 100% dyed acrylic fiber which is thermoplastic. DO NOT SUBJECT TO EXCESSIVE HEAT. When Sunbrella® fabric is stored, it should be cleaned, allowed to dry and stored in a dry, well ventilated area. Sunbrella® Care and Cleaning Performance moisture-resistant fabrics are extremely easy to keep clean and beautiful. Proper maintenance, vacuuming regularly and rotating seat cushions frequently keeps your furniture looking good and promotes long fabric life.



GENERAL CLEANING METHODS

Brush off dirt before it becomes imbedded in the fabric, wipe up spills as soon as they occur, and spot-clean by sponging cushions with mild soap and warm water.

MACHINE-WASHING

Remove cushions from cushion covers. Machine-wash fabric in cold water with mild laundry soap, or use 7 parts bleach to 3 parts cold water, hang and allow to air-dry.

HAND-WASHING

Soak fabric in a solution of ¼-cup mild soap per gallon of lukewarm water. Use a sponge or a soft bristle brush as necessary. Rinse thoroughly with clean water. Hang and allow to air-dry. These fabrics usually air-dry very quickly.

SPOT-CLEANING UPHOLSTERED PIECES

Apply a light mist of mild soap and water using a spray bottle. Remove the stain with a sponge or a very soft bristle brush. Rinse with clean water and air-dry, blotting or wet-vacuuming excess water. Repeat until all soap residue is removed.

OUR STORY

For nearly 63 years GAR Products has been on a journey - one that started from humble surroundings in Newark, New Jersey and marched steadily south towards our current vision in Lakewood, New Jersey. Founded by Ellie and "GAR", then taken over by Ellen and Jay, the fairy tale of GAR Products continues.

At GAR Products, we believe we are the stewards of the land - dedicated to being environmentally and socially responsible to not only our community, but to all of our clients nationwide. To us, sustainability goes beyond ethical practices; it's who we are. It is our mission to be good to the earth and socially aware.

From our team to yours, all aboard our train. Can't wait for you to experience where our company was, is and will be.

Welcome Aboard!

“Where the spirit does not work with the hand, there is no art”

- Leonardo Da Vinci

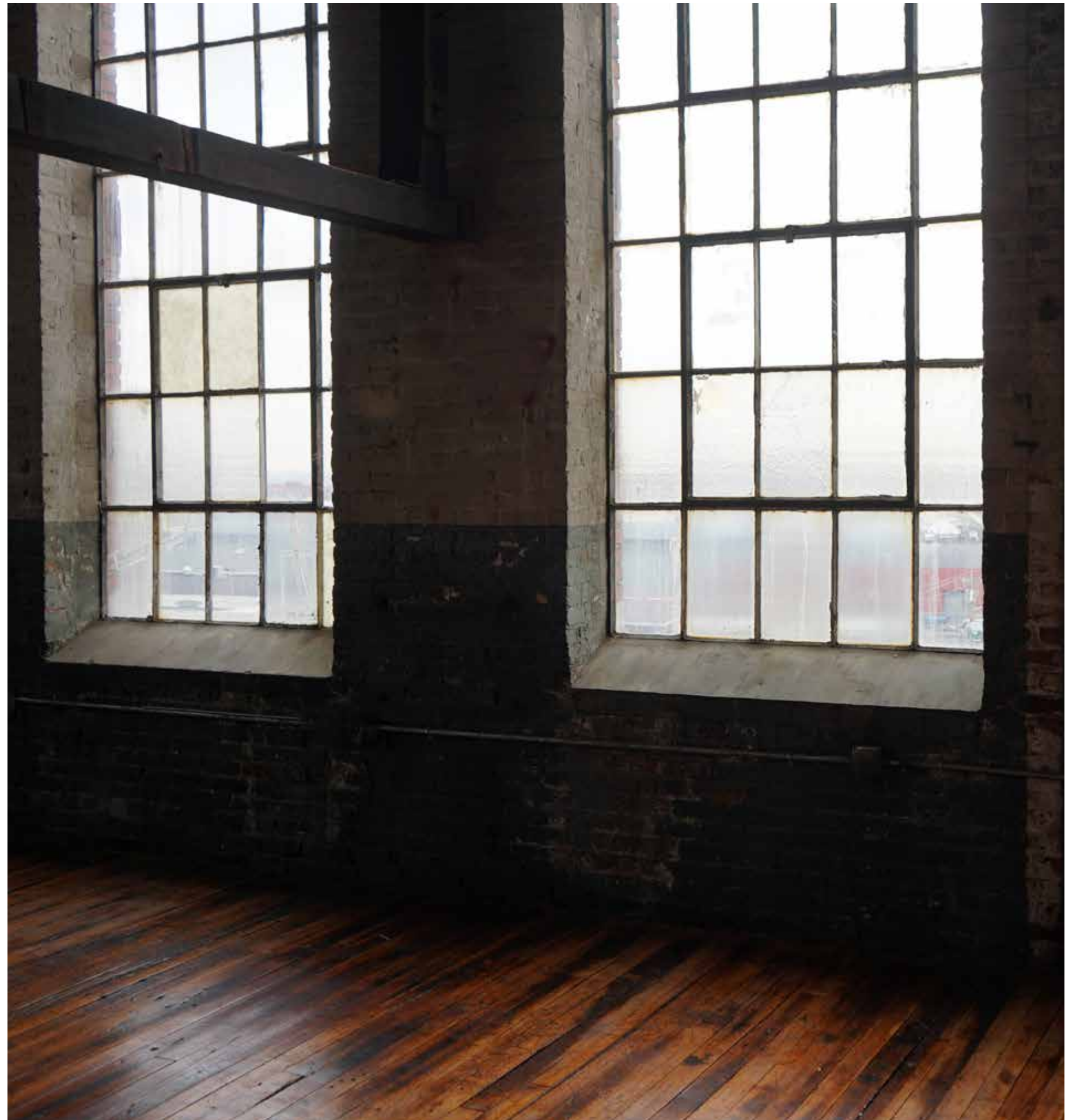



GAR[®]
PRODUCTS

170 Lehigh Avenue, Lakewood, NJ 08701 | 800.424.2477 | www.garproducts.com