



# BEVERAGE-AIR®

2019  
CATALOG



**YOUR COMPLETE  
REFRIGERATION  
SOURCE**

888-845-9800 | [beverage-air.com](http://beverage-air.com)



# BEVERAGE-AIR

## DELIVERING UNMATCHED VALUE AND QUALITY SINCE 1944

Founded in 1944 by John Buffington, Beverage-Air is a leading manufacturer of commercial refrigeration equipment for the food service industry. Our legacy of innovation began with the invention of the first horizontal bottle cooler over 70 years ago. Beverage-Air is defined by a resolute commitment to our customers, the industry, and the environment.

In 2008, the Ali Group acquired Beverage-Air. The Ali Group is one of the largest and most diversified global leaders in the food service equipment industry. Founded in 1963 by Luciano Berti, Ali Group today employs more than 10,000 people in 30 countries and operates 57 manufacturing facilities worldwide.

Beverage-Air corporate headquarters is located in Winston-Salem, North Carolina, and in an effort to leverage efficiencies in manufacturing and distribution, all of these operations are now based in Brookville, Pennsylvania. The Brookville operation is a state of the art facility, employing committed people, many of whom have worked in the industry their entire professional lives. Often second and third generation employees work side by side to drive innovating thinking and quality manufacturing.

**On behalf of everyone at Beverage-Air, we would like to thank you for your continued support of the Beverage-Air brand.**





Beverage-Air has a full range of premium refrigeration and food service equipment solutions to meet the diverse needs of convenience stores, supermarkets, restaurants, and other retail environments.





# BEVERAGE-AIR

## AFTERMARKET SERVICES

As a Beverage-Air customer, our commitment to you continues with the ongoing support of our aftermarket services. This program provides you access to a full range of support tools.

### YOU HAVE ACCESS TO THE FOLLOWING:

- Ongoing technical support via telephone
- Product Customization
- Qualified parts distributor network
- Qualified network of reputable service technicians
- 24/7 Service and maintenance dispatch
- Online manuals & parts breakdown
- Online warranty claims processing  
*(warranty on page 150)*

## CUSTOMER COMMITMENT

Committed to innovation, excellence, and customer satisfaction, Beverage-Air continually works to leverage efficiencies in manufacturing and distribution to benefit our customers.

### WE COMMIT ALL OF THE FOLLOWING TO YOU:

- Industry-leading quality and customer satisfaction
- Award-winning product innovation
- Competitive pricing
- Factory Inventory
- Energy efficient products
- Complete aftermarket services

### Factory Headquarters Sales Office

3779 Champion Blvd  
Winston-Salem, NC 27105  
Phone: (336) 245-6400  
Fax: (336) 245-6453  
Email: [sales@bevair.com](mailto:sales@bevair.com)  
Web: [www.beverage-air.com](http://www.beverage-air.com)

### 24/7 Warranty Service Dispatch

(877) 866-1223

### Factory Technical Service

Phone: (800) 684-1199  
Fax: (800) 262-9381

### Factory Customer Service

Phone: (888) 845-9800  
Fax: (800) 253-5168



# TABLE OF CONTENTS

## Top Mount Reach-Ins 4

|       |                |   |
|-------|----------------|---|
| HR/HF | Horizon Series | 6 |
|-------|----------------|---|

## Bottom Mount Reach-Ins 12

|         |                |    |
|---------|----------------|----|
| RB/FB   | Vista Series   | 14 |
| HBR/HBF | Horizon Series | 18 |
| RI      | RI Series      | 22 |

## Spec Line 26

|          |                         |    |
|----------|-------------------------|----|
| PR/PH/PF | P-Series                | 28 |
| CT       | Cross-Temp Series       | 36 |
| CF/BF    | Blast Chillers          | 40 |
| BC       | Williams Blast Chillers | 42 |

## Glass Door Merchandisers 46

|           |                  |    |
|-----------|------------------|----|
| MT        | Marketeer Series | 48 |
| MM        | MarketMax Series | 50 |
| CR/CF/CTF | Countertop Units | 54 |
| BDC/NC    | Dipping Cabinets | 56 |

## Open Air Merchandisers 62

|    |               |    |
|----|---------------|----|
| BZ | Breeze Series | 64 |
| VM | VueMax        | 66 |

## Food Prep Tables 70

|     |                   |    |
|-----|-------------------|----|
| SPE | Elite Series      | 72 |
| DP  | Pizza Prep Tables | 86 |

## Worktops & Undercounters 96

|         |               |     |
|---------|---------------|-----|
| WTR/WTF | Worktops      | 98  |
| UCR/UCF | Undercounters | 110 |

## Chef Bases 120

|           |            |     |
|-----------|------------|-----|
| WTRC/WTFC | Chef Bases | 122 |
|-----------|------------|-----|

## Bar & Wine Equipment 126

|           |                       |     |
|-----------|-----------------------|-----|
| DD/DZ/BM  | Direct Draw           | 128 |
| BM23/DZ24 | Bar Mobile            | 132 |
| BB/DZ     | Back Bar              | 134 |
| DW        | Bottle Coolers        | 144 |
| GF/FLG    | Glass & Plate Chiller | 146 |

## Milk Coolers 152

|    |            |     |
|----|------------|-----|
| SM | Cold wall  | 155 |
| ST | Forced Air | 156 |

## Beverage-Air

|                    |     |
|--------------------|-----|
| Warranty           | 158 |
| Contacts/Directory | 160 |



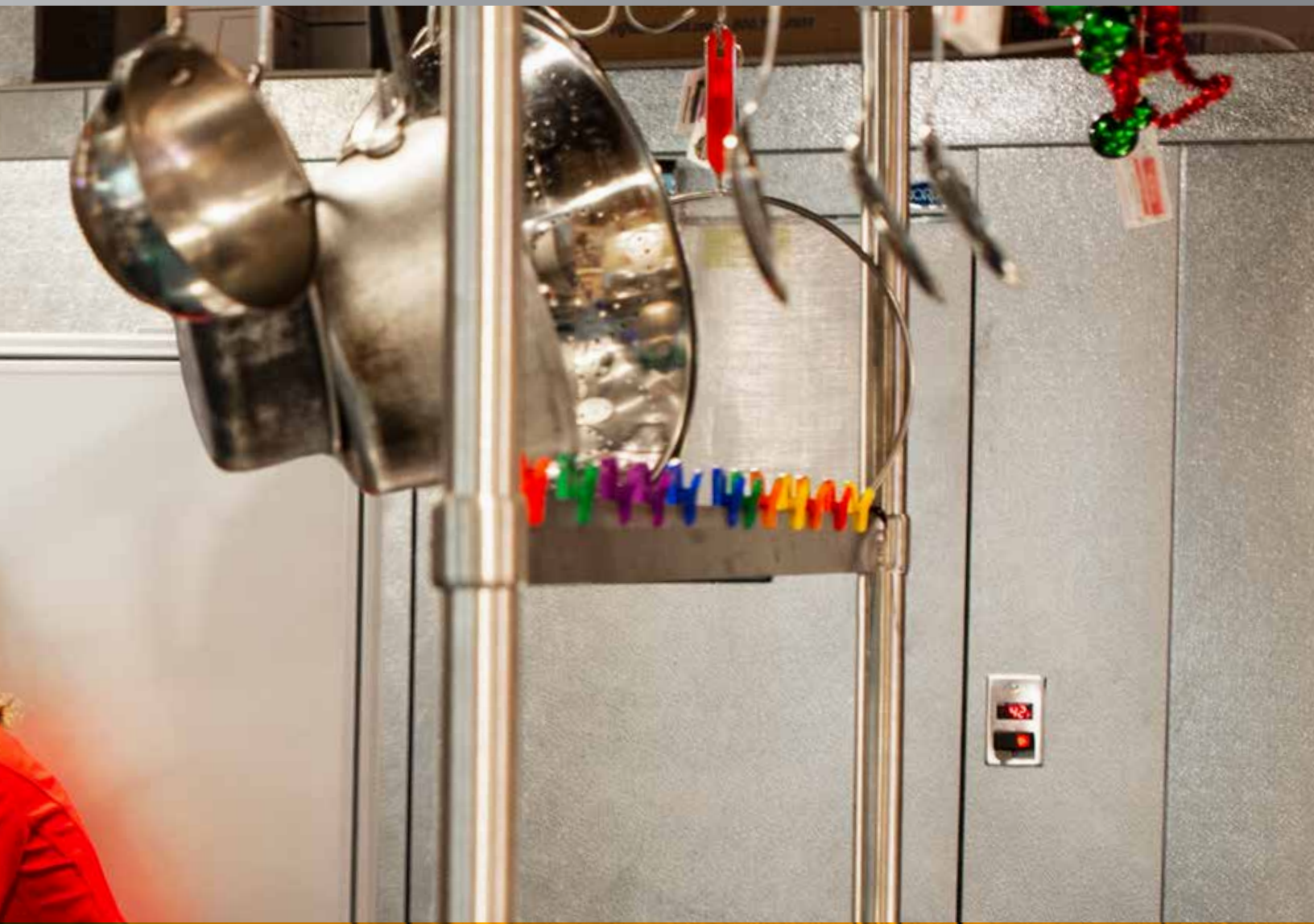

# TOP MOUNT REACH-INS

DESIGNED TO EXCEED EXPECTATIONS IN TOUGH KITCHEN ENVIRONMENTS

# HORIZON<sup>®</sup> SERIES

## Heavy Duty Construction

2" CFC and HCFC-free foamed-in place polyurethane insulation

## Full electronic Control

with one-touch defrost

## Multiple finish options

## Door locks standard

Solid doors only (optional on glass door models)

## Field-reversible doors

## Cam-lift hinges

with 120 degree stay open feature

## LED lighting standard

## Back rack airflow distribution system

## Anti-microbial door handles

## Self-closing doors

## 6" heavy duty casters standard

3" casters or 6" leg option available at no charge when specified on order

## HC models featuring environmentally friendly, energy efficient R290 refrigerant



**DESIGNED TO PERFORM IN HIGH AMBIENT CONDITIONS**

**3 YEAR PARTS AND LABOR / ADDITIONAL 2 YEAR COMPRESSOR PART WARRANTY**

**MADE IN USA**



**BACK CHANNEL**  
to promote air flow



**FIELD REVERSIBLE DOORS**  
for flexibility to get your kitchen set up exactly how you want it

## AVAILABLE DOORS

- Solid (one full-door)
- Half Solid (two half-doors)
- Glass (one full-door)
- Half Glass (two half-doors)

## AGENCY CERTIFICATIONS





# Refrigerators & Freezers



## EXTERIOR FINISHES

- Stainless steel front with continuous coil coated sides
- Stainless steel sides/front

## INTERIOR FINISHES

- Corrosion resistant aluminum
- Stainless steel

## AVAILABLE ACCESSORIES

- Tray Slides
- Additional shelves
- Wine models

## MOUNTING OPTIONS

- 6" casters (standard)
- 6" legs
- 3" casters
- Flanged/seismic feet

## AVAILABLE OPTIONS

- Left hand hinge doors
- Remote models available



# HORIZON® SERIES

## REFRIGERATORS

MAINTAINS PRODUCT TEMPERATURES OF 36-38°F.

| MODEL WIDTH                  | DOOR TYPE  | MODEL NUMBERS      |             |             |              | DOORS/<br>SHELVES | VOLTS | HP  | AMPS | CUBIC<br>FEET | WIDTH | DEPTH | HEIGHT | CRATED<br>WEIGHT |
|------------------------------|------------|--------------------|-------------|-------------|--------------|-------------------|-------|-----|------|---------------|-------|-------|--------|------------------|
|                              |            | STANDARD<br>FINISH | FINISH<br>P | FINISH<br>S | FINISH<br>PS |                   |       |     |      |               |       |       |        |                  |
| <b>26"</b><br>1 SECTION      | SOLID      | HR1HC-1S           | HRP1HC-1S   | HRS1HC-1S   | HRPS1HC-1S   | 1/3               | 115   | 1/4 | 4.3  | 21.17         | 26    | 33.63 | 78.5   | 326              |
|                              | HALF SOLID | HR1HC-1HS          | HRP1HC-1HS  | HRS1HC-1HS  | HRPS1HC-1HS  | 2/3               |       |     |      |               |       |       |        | 324              |
|                              | GLASS      | HR1HC-1G           | HRP1HC-1G   | HRS1HC-1G   | HRPS1HC-1G   | 1/3               | 115   | 1/4 | 4.3  | 22.28         |       |       |        | 429              |
|                              | HALF GLASS | HR1HC-1HG          | HRP1HC-1HG  | HRS1HC-1HG  | HRPS1HC-1HG  | 2/3               |       |     |      |               |       |       |        | 356              |
| <b>35"</b><br>1 WIDE SECTION | SOLID      | HR1W-1S            | HRP1W-1S    | HRS1W-1S    | HRPS1W-1S    | 1/3               | 115   | 1/3 | 5.8  | 30.76         | 35    | 33.63 | 78.5   | 418              |
|                              | GLASS      | HR1W-1G            | HRP1W-1G    | HRS1W-1G    | HRPS1W-1G    |                   |       |     |      |               |       |       |        | 429              |
| <b>52"</b><br>2 SECTIONS     | SOLID      | HR2-1S             | HRP2-1S     | HRS2-1S     | HRPS2-1S     | 2/6               | 115   | 1/3 | 8.4  | 46.88         | 52    | 33.63 | 78.5   | 506              |
|                              | HALF SOLID | HR2-1HS            | HRP2-1HS    | HRS2-1HS    | HRPS2-1HS    |                   |       |     |      |               |       |       |        | 543              |
|                              | GLASS      | HR2-1G             | HRP2-1G     | HRS2-1G     | HRPS2-1G     |                   |       |     |      |               |       |       |        | 571              |
|                              | HALF GLASS | HR2-1HG            | HRP2-1HG    | HRS2-1HG    | HRPS2-1HG    |                   |       |     |      |               |       |       |        | 543              |
| <b>78"</b><br>3 SECTIONS     | SOLID      | HR3-1S             | HRP3-1S     | HRS3-1S     | HRPS3-1S     | 3/9               | 115   | 1/2 | 10   | 71.52         | 78    | 33.63 | 78.5   | 791              |
|                              | HALF SOLID | HR3-1HS            | HRP3-1HS    | HRS3-1HS    | HRPS3-1HS    |                   |       |     |      |               |       |       |        | 791              |
|                              | GLASS      | HR3-1G             | HRP3-1G     | HRS3-1G     | HRPS3-1G     |                   |       |     |      |               |       |       |        | 737              |
|                              | HALF GLASS | HR3-1HG            | HRP3-1HG    | HRS3-1HG    | HRPS3-1HG    |                   |       |     |      |               |       |       |        | 791              |

Depth measurement includes handles.  
For total height, add 3 or 6 inches, based on your mounting choice.

| FINISH OPTIONS REFRIGERATOR & FREEZER |   |                              |
|---------------------------------------|---|------------------------------|
| SUFFIX                                | EXTERIOR  | INTERIOR                     |
| (standard)                            | Stainless steel front with continuous coil coated sides | Corrosion resistant aluminum |
| <b>P</b>                              | Stainless steel front with stainless steel sides        | Corrosion resistant aluminum |
| <b>S</b>                              | Stainless steel front with continuous coil coated sides | Stainless steel              |
| <b>PS</b>                             | Stainless steel front with stainless steel sides        | Stainless steel              |

| AVAILABLE OPTIONS |                         |
|-------------------|-------------------------|
| SUFFIX            |                         |
| <b>18</b>         | Left hand hinge doors   |
| <b>R</b>          | Remote models available |

Append suffix to model # when placing order. Ex: HR2-1S-18

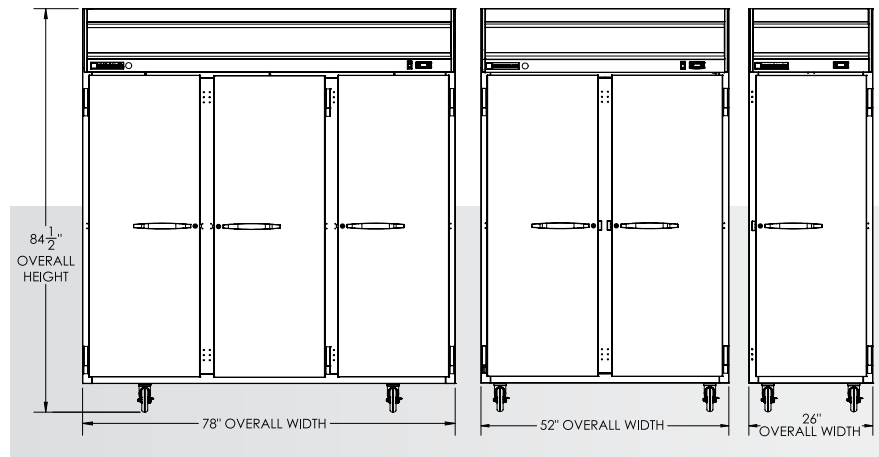

## FREEZERS

MAINTAINS PRODUCT TEMPERATURES OF -10°F.

| MODEL WIDTH                  | DOOR TYPE  | MODEL NUMBERS      |             |             |              | DOORS/<br>SHELVES | VOLTS | HP    | AMPS | CUBIC<br>FEET | WIDTH | DEPTH | HEIGHT | CRATED<br>WEIGHT |
|------------------------------|------------|--------------------|-------------|-------------|--------------|-------------------|-------|-------|------|---------------|-------|-------|--------|------------------|
|                              |            | STANDARD<br>FINISH | FINISH<br>P | FINISH<br>S | FINISH<br>PS |                   |       |       |      |               |       |       |        |                  |
| <b>26"</b><br>1 SECTION      | SOLID      | HF1HC-1S           | HFP1HC-1S   | HFS1HC-1S   | HFPS1HC-1S   | 1/3               | 115   | 3/4   | 8.8  | 21.06         | 26    | 33.63 | 78.5   | 336              |
|                              | HALF SOLID | HF1HC-1HS          | HFP1HC-1HS  | HFS1-1HS    | HFPS1HC-1HS  | 2/3               |       |       |      |               |       |       |        | 340              |
|                              | GLASS      | HF1HC-1G           | HFP1HC-1G   | HFS1HC-1G   | HFPS1HC-1G   | 1/3               |       |       |      |               |       |       |        | 368              |
|                              | HALF GLASS | HF1HC-1HG          | HFP1HC-1HG  | HFS1HC-1HG  | HFPS1HC-1HG  | 2/3               |       |       |      |               |       |       |        | 360              |
| <b>35"</b><br>1 WIDE SECTION | SOLID      | HF1W-1S            | HFP1W-1S    | HFS1W-1S    | HFPS1W-1S    | 1/3               | 115   | 1/2   | 7.8  | 34            | 35    | 33.63 | 78.5   | 334              |
| <b>52"</b><br>2 SECTIONS     | SOLID      | HF2-1S             | HFP2-1S     | HFS2-1S     | HFPS2-1S     | 2/6               | 115   | 3/4   | 12   | 49            | 52    | 33.63 | 78.5   | 568              |
|                              | HALF SOLID | HF2-1HS            | HFP2-1HS    | HFS2-1HS    | HFPS2-1HS    | 4/6               |       |       |      |               |       |       |        | 550              |
|                              | GLASS      | HF2-1G             | HFP2-1G     | HFS2-1G     | HFPS2-1G     | 2/6               | 115   | 1     | 16   |               |       |       |        | 625              |
|                              | HALF GLASS | HF2-1HG            | HFP2-1HG    | HFS2-1HG    | HFPS2-1HG    | 4/6               |       |       |      |               |       |       |        | 550              |
| <b>78"</b><br>3 SECTIONS     | SOLID      | HF3-5S             | HFP3-5S     | HFS3-5S     | HFPS3-5S     | 3/9               | 208   | 1     | 8.4  | 74            | 78    | 33.5  | 78.5   | 732              |
|                              | HALF SOLID | HF3-5HS            | HFP3-5HS    | HFS3-5HS    | HFPS3-5HS    | 6/9               |       |       |      |               |       |       |        | 732              |
|                              | GLASS      | HF3-5G             | HFP3-5G     | HFS3-5G     | HFPS3-5G     | 3/9               | 208   | 1-1/2 | 16   |               |       |       |        | 732              |
|                              | HALF GLASS | HF3-5HG            | HFP3-5HG    | HFS3-5HG    | HFPS3-5HG    | 6/9               |       |       |      |               |       |       |        | 732              |

Depth measurement includes handles.  
For total height, add 3 or 6 inches, based on your mounting choice.

## ADAPTIVE DEFROST

- Reduces energy consumption up to 15%
- Units are able to provide a consistent product temperature throughout the cabinet even during defrost cycles
- Reduces the overall time defrosting versus traditional timed defrost
- Example: Adaptive Defrost: 48 min total in 4 cycles versus 60 min in 3 cycles (Traditional 8HR)
- High Ambient and Humidity testing shows the system's ability to perform better in high usage environments under unfavorable conditions

Increased Consistency of Product Temperatures (Fahrenheit)

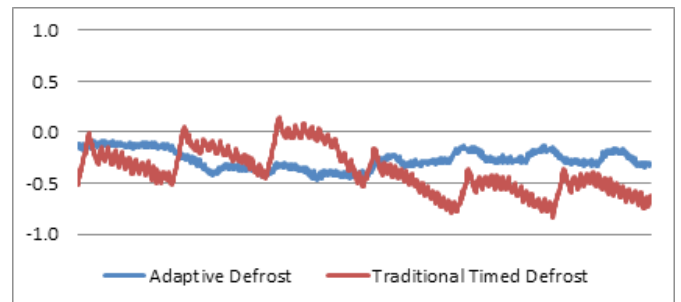

# Top Mount Reach-In Accessories

| DESCRIPTION  | UNIT(S)                                   | PART NUMBER       |
|--|---|-------------------|
| <b>SHELVING / ORGANIZERS</b>   |   |                   |
| Epoxy Coated Wire Shelf  | H Series Flat Shelving 1 Door Unit        | 403-889D-01       |
| Epoxy Coated Wire Shelf  | H Series Flat Shelving HR1W Units         | 403-888D-01       |
| Epoxy Coated Wire Shelf  | H Series Flat Shelving 2 Door Unit        | 403-887D-01       |
| Epoxy Coated Center Shelf  | H Series Flat Shelving 3 Door Unit        | 403-893D-01       |
| Epoxy Coated Wire Shelf  | H Series Flat Shelving 3 Door Unit        | 403-887D-01       |
| S/S Shelves  | H Series Flat Shelving 1 Door Unit        | 403-889D-04       |
| S/S Shelves  | H Series Flat Shelving 1 Door Wide Unit   | 403-888D-04       |
| S/S Shelves  | H Series Flat Shelving 2 & 3 Door Unit    | 403-887D-04       |
| S/S Shelves  | H Series Flat Shelving 3 Door Unit-Center | 403-893D-04       |
| Shelf Clip   | Any H Series Unit                         | 403-169A          |
| <b>MOUNTING</b>  |   |                   |
| 6" Caster  | Any H Series Unit (set of four)           | 61C01-001A        |
| 3" Caster  | Any H Series Unit (set of four)           | 61C01-013A        |
| 6" Black Leg   | Any H Series Unit (set of four)           | 58B02S001A        |
| 6" Seismic/Flanged Legs  | Any H Series Unit (set of four)           | 00C31-055A        |
| <b>ADDITIONAL ACCESSORIES</b>  |   |                   |
| Door Lock  | Any Glass Door H Series Unit (per door)   | 61C11S032A        |
| S/S Breakers Half Door   | Any H Series Unit                         | 61C08-019A        |
| S/S Breakers Full Door   | Any H Series Unit                         | 61C08-020A        |
| <b>TRAY SLIDE KITS</b>   |   |                   |
| <b>TYPE "A" STANDARD &amp; EXTRA WIDE UNITS</b>                                    |   |                   |
| 1 tray slide set for:<br>one 18x26" pan, or two 14x18" pans                        | H-Series                                  | 10601211S         |
| <b>TYPE "A/C" STANDARD &amp; EXTRA WIDE UNITS</b>                                  |   |                   |
| 1 tray slide set for:<br>one 18x26" pan, or two 14x18" pans,<br>or two 12x20" pans | H-Series                                  | 10601201S         |
| <b>KIT #4 EPOXY COATED WIRE ROD TRAY SLIDE</b>                                     |   |                   |
| 19 SETS PER 1/2 SECTION  | H Series - 1 Door Unit                    | 61C31-251A-01 (2) |
|  | H Series - 2 Door Unit                    | 61C31-251A-02 (2) |
|  | H Series - 3 Door                         | 61C31-251A-03 (2) |

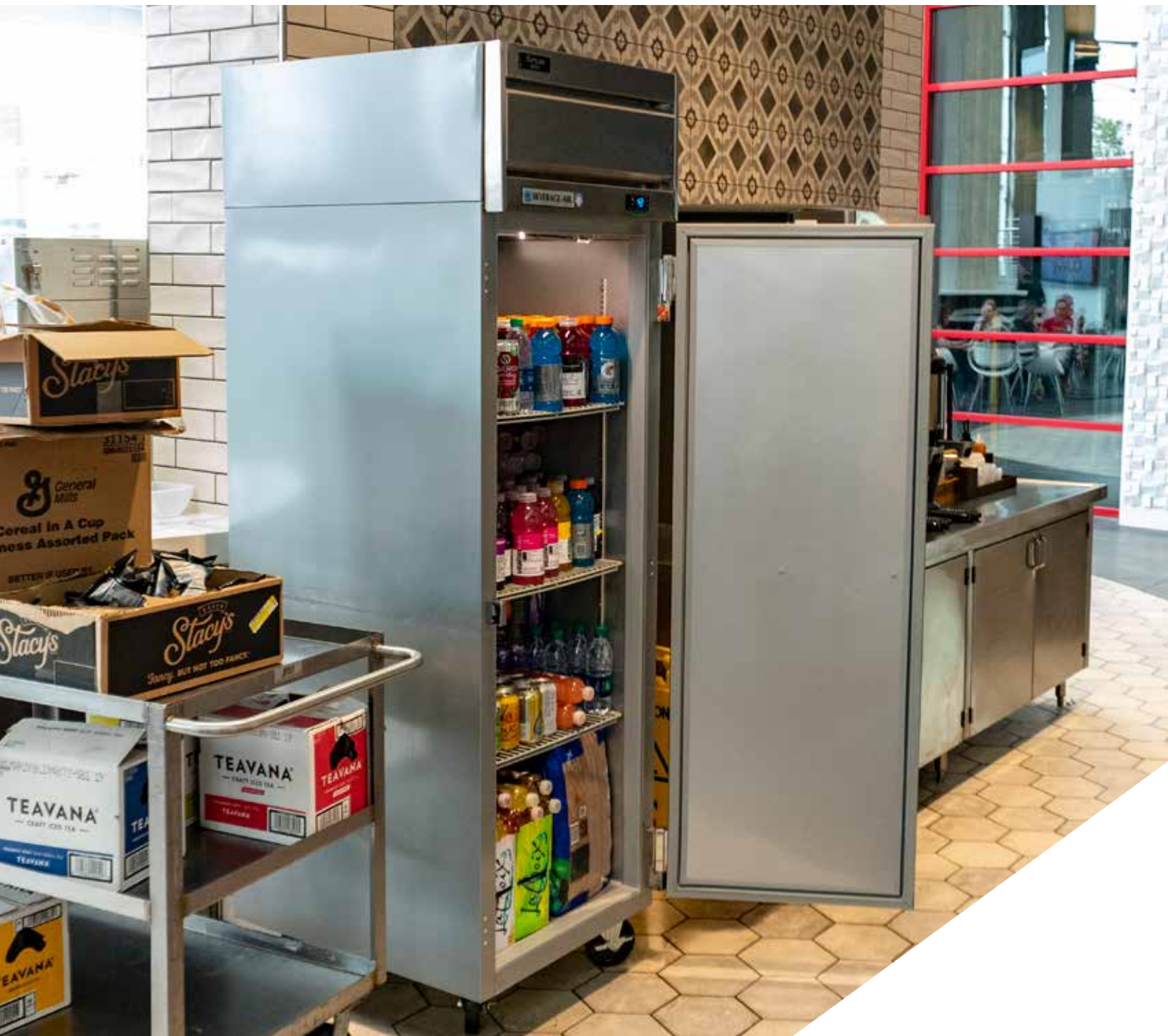





# **BOTTOM MOUNT REACH-INS**

**MULTIPLE OPTIONS TO MEET ANY COOLING CHALLENGE OR ENVIRONMENT**

# VISTA® SERIES

## Full electronic control

## Door locks standard

(solid doors only, optional on glass door models)

## One piece grille

## Cartridge style door hinges

with 120 degree stay-open feature

## LED lighting standard

## Anti-microbial door handles

## Self-closing doors

## Right and left hand hinged models available

(specify at time of order)

## 6" heavy duty casters standard

(3" casters or 6" leg option available at no charge when specified on order)

## HC models featuring environmentally friendly, energy efficient R290 refrigerant



**DESIGNED TO PERFORM IN HIGH AMBIENT CONDITIONS**

**3 YEAR PARTS AND LABOR / ADDITIONAL 2 YEAR COMPRESSOR PART WARRANTY**

**MADE IN USA**

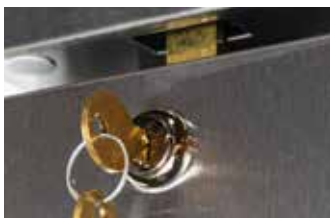

**DOOR LOCKS STANDARD**  
on solid door units for loss prevention  
(available as an option for glass doors)



**ANTI-MICROBIAL HANDLES**  
destroy or inhibit microorganisms,  
helping prevent the spread of germs

## AVAILABLE DOORS

- Solid (one full-door)
- Glass (one full-door)

## AGENCY CERTIFICATIONS





# Refrigerators & Freezers



## EXTERIOR FINISHES

- Stainless steel front with continuous coil coated sides

## INTERIOR FINISHES

- Corrosion resistant aluminum

## AVAILABLE ACCESSORIES

- Additional shelves
- Tray slide kits

## MOUNTING OPTIONS

- 6" casters (standard)
- 6" legs
- 3" casters
- Flanged/seismic feet

## AVAILABLE OPTIONS

- Left hand hinge doors
- Remote models available



# VISTA® SERIES

## REFRIGERATORS

MAINTAINS PRODUCT TEMPERATURES OF 36-38°F.

| MODEL WIDTH              | DOOR TYPE | MODEL #          | DOORS/SHELVES | VOLTS | HP  | AMPS | CUBIC FEET | WIDTH | DEPTH | HEIGHT | CRATED WEIGHT |
|--------------------------|-----------|------------------|---------------|-------|-----|------|------------|-------|-------|--------|---------------|
| <b>27"</b><br>1 SECTION  | SOLID     | <b>RB23HC-1S</b> | 1/3           | 115   | 1/4 | 3    | 23.1       | 27    | 33.75 | 78     | 316           |
|                          | GLASS     | <b>RB23HC-1G</b> |               |       |     |      |            |       |       |        | 346           |
| <b>30"</b><br>1 SECTION  | SOLID     | <b>RB27HC-1S</b> | 1/3           | 115   | 1/4 | 3    | 25.88      | 30    | 33.75 | 78     | 358           |
|                          | GLASS     | <b>RB27HC-1G</b> |               |       |     |      |            |       |       |        | 373           |
| <b>52"</b><br>2 SECTIONS | SOLID     | <b>RB49HC-1S</b> | 2/6           | 115   | 1/3 | 5    | 46.15      | 52    | 33.75 | 78     | 536           |
|                          | GLASS     | <b>RB49HC-1G</b> |               |       |     |      |            |       |       |        | 566           |
| <b>75"</b><br>3 SECTIONS | SOLID     | <b>RB72HC-1S</b> | 3/9           | 115   | 1/2 | 6.2  | 68.93      | 75    | 33.75 | 78     | 696           |
|                          | GLASS     | <b>RB72HC-1G</b> |               |       |     |      |            |       |       |        | 696           |

Depth measurement includes handles.  
For total height, add 3 or 6 inches, based on your mounting choice.

### AVAILABLE OPTIONS

| SUFFIX    |                         |
|-----------|-------------------------|
| <b>18</b> | Left hand hinge doors   |
| <b>R</b>  | Remote models available |

Append suffix to model # when placing order. Ex: **RB49HC-1S-18**

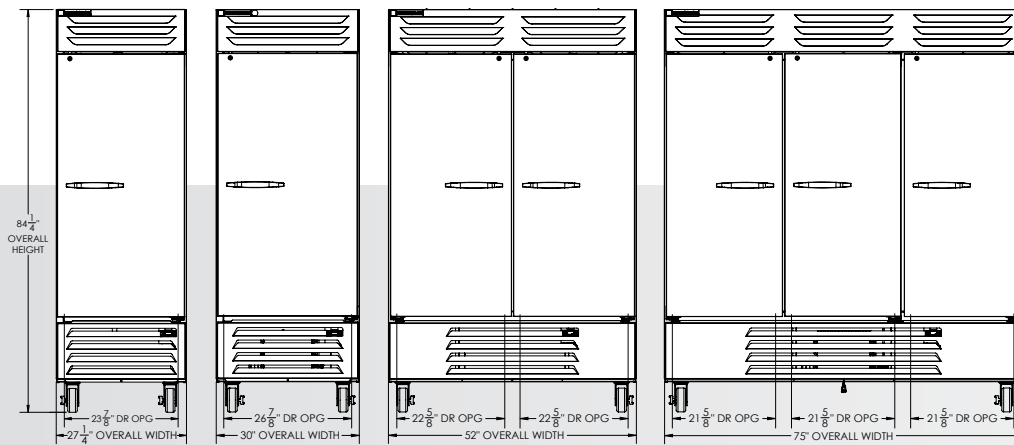

## FREEZERS

MAINTAINS PRODUCT TEMPERATURES OF -10°F.

| MODEL WIDTH              | DOOR TYPE | MODEL #          | DOORS/<br>SHELVES | VOLTS | HP  | AMPS | CUBIC<br>FEET | WIDTH | DEPTH | HEIGHT | CRATED<br>WEIGHT |
|--------------------------|-----------|------------------|-------------------|-------|-----|------|---------------|-------|-------|--------|------------------|
| <b>27"</b><br>1 SECTION  | SOLID     | <b>FB23HC-1S</b> | 1/3               | 115   | 3/4 | 7.5  | 22.5          | 27.25 | 33.75 | 78     | 408              |
|                          | GLASS     | <b>FB23HC-1G</b> |                   |       |     |      |               |       |       |        |                  |
| <b>30"</b><br>1 SECTION  | SOLID     | <b>FB27HC-1S</b> | 1/3               | 115   | 3/4 | 7.5  | 26.57         | 30    | 33.75 | 78     | 438              |
|                          | GLASS     | <b>FB27HC-1G</b> |                   |       |     |      |               |       |       |        |                  |
| <b>52"</b><br>2 SECTIONS | SOLID     | <b>FB49HC-1S</b> | 2/6               | 115   | 3/4 | 11   | 46.2          | 52    | 33.75 | 78     | 564              |
|                          | GLASS     | <b>FB49HC-1G</b> |                   |       |     |      |               |       |       |        |                  |
| <b>75"</b><br>3 SECTIONS | SOLID     | <b>FB72-1S</b>   | 3/9               | 115   | 3/4 | 11.9 | 68.5          | 75    | 33.75 | 78     | 725              |
|                          | GLASS     | <b>FB72-G</b>    |                   |       |     |      |               |       |       |        |                  |

*Depth measurement includes handles.  
For total height, add 3 or 6 inches, based on your mounting choice.*



# HORIZON<sup>®</sup> SERIES

## Heavy Duty Construction

(2" CFC and HCFC-free foamed-in place polyurethane insulation)

## Full electronic Control

with one-touch defrost

## Door locks standard

(solid doors only, optional on glass door models)

## Cartridge-style hinges

with 120 degree stay open feature

## LED lighting standard

## Anti-microbial door handles

## Self-closing doors

## 6" heavy duty casters standard

(3" casters or 6" leg option available at no charge when specified on order)

## HC models featuring environmentally friendly, energy efficient R290 refrigerant



**DESIGNED TO PERFORM IN HIGH AMBIENT CONDITIONS**

**3 YEAR PARTS AND LABOR / ADDITIONAL 2 YEAR COMPRESSOR PART WARRANTY**

**MADE IN USA**



**FULL ELECTRONIC CONTROL**  
with easy to read digital display



**ANTI-MICROBIAL HANDLES**  
destroy or inhibit microorganisms,  
helping prevent the spread of germs

## AVAILABLE DOORS

- Solid (one full-door)
- Half Solid (two half-doors)
- Glass (one full-door)
- Half Glass (two half-doors)

## AGENCY CERTIFICATIONS



# Refrigerators & Freezers



## EXTERIOR FINISHES

- Stainless steel

## INTERIOR FINISHES

- Stainless steel

## AVAILABLE ACCESSORIES

- Additional shelves
- Tray slide kits
- Wine models
- Dual-temp

## MOUNTING OPTIONS

- 6" casters (standard)
- 6" legs
- 3" casters
- Flanged/seismic feet

## AVAILABLE OPTIONS

- Left hand hinge doors
- Remote models available



# HORIZON® SERIES

## REFRIGERATORS

MAINTAINS PRODUCT TEMPERATURES OF 36-38°F.

| MODEL WIDTH              | DOOR TYPE  | MODEL #             | DOORS/SHELVES | VOLTS | HP  | AMPS | CUBIC FEET | WIDTH | DEPTH | HEIGHT | CRATED WEIGHT |
|--------------------------|------------|---------------------|---------------|-------|-----|------|------------|-------|-------|--------|---------------|
| <b>24"</b><br>1 SECTION  | SOLID      | <b>HBR12HC-1</b>    | 1/4           | 115   | 1/6 | 2    | 12.06      | 24    | 26    | 62     | 250           |
|                          | GLASS      | <b>HBR12HC-1-G</b>  |               |       |     |      |            |       |       |        |               |
| <b>27"</b><br>1 SECTION  | SOLID      | <b>HBR23HC-1</b>    | 1/3           | 115   | 1/4 | 3    | 23.1       | 27.25 | 33.75 | 78     | 400           |
|                          | HALF SOLID | <b>HBR23-1-HS</b>   | 2/3           | 115   | 1/3 | 5.8  |            |       |       |        | 400           |
|                          | GLASS      | <b>HBR23HC-1-G</b>  | 1/3           | 115   | 1/4 | 3    |            |       |       |        | 392           |
|                          | HALF GLASS | <b>HBR23HC-1-HG</b> | 2/3           | 115   | 1/4 | 3    |            |       |       |        | 436           |
| <b>30"</b><br>1 SECTION  | SOLID      | <b>HBR27HC-1</b>    | 1/3           | 115   | 1/4 | 3    | 25.88      | 30    | 33.75 | 78     | 396           |
|                          | HALF SOLID | <b>HBR27-1-HS</b>   | 2/3           | 115   | 1/3 | 5.8  |            |       |       |        | 373           |
|                          | GLASS      | <b>HBR27HC-1-G</b>  | 1/3           | 115   | 1/4 | 3    |            |       |       |        | 378           |
|                          | HALF GLASS | <b>HBR27HC-1-HG</b> | 2/3           | 115   | 1/4 | 3    |            |       |       |        | 414           |
| <b>47"</b><br>2 SECTIONS | SOLID      | <b>HBR44HC-1</b>    | 2/6           | 115   | 1/3 | 5    | 40.2       | 47    | 33.75 | 78     | 534           |
|                          | HALF SOLID | <b>HBR44-1-HS</b>   | 4/6           | 115   | 1/3 | 8.8  |            |       |       |        | 530           |
|                          | GLASS      | <b>HBR44HC-1-G</b>  | 2/6           | 115   | 1/3 | 5    |            |       |       |        | 538           |
|                          | HALF GLASS | <b>HBR44HC-1-HG</b> | 4/6           | 115   | 1/3 | 5    |            |       |       |        | 538           |
| <b>52"</b><br>2 SECTIONS | SOLID      | <b>HBR49HC-1</b>    | 2/6           | 115   | 1/3 | 5    | 46.15      | 52    | 33.75 | 78     | 594           |
|                          | HALF SOLID | <b>HBR49-1-HS</b>   | 4/6           | 115   | 1/3 | 8.8  |            |       |       |        | 530           |
|                          | GLASS      | <b>HBR49HC-1-G</b>  | 2/6           | 115   | 1/3 | 5    |            |       |       |        | 608           |
|                          | HALF GLASS | <b>HBR49HC-1-HG</b> | 4/6           | 115   | 1/3 | 5    |            |       |       |        | 604           |
| <b>75"</b><br>3 SECTIONS | SOLID      | <b>HBR72HC-1</b>    | 3/9           | 115   | 1/2 | 6.2  | 68.93      | 75    | 33.75 | 78     | 764           |
|                          | HALF SOLID | <b>HBR72-1-HS</b>   | 3/9           | 115   | 1/2 | 9.9A |            |       |       |        | 771           |
|                          | GLASS      | <b>HBR72HC-1-G</b>  | 3/9           | 115   | 1/2 | 6.2  |            |       |       |        | 764           |
|                          | HALF GLASS | <b>HBR72-1-HG</b>   | 3/9           | 115   | 1/2 | 9.9A |            |       |       |        | 771           |

Depth measurement includes handles.  
For total height, add 3 or 6 inches, based on your mounting choice.

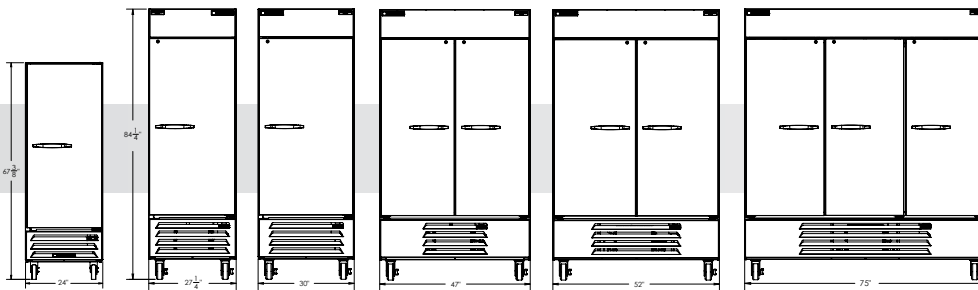

### AVAILABLE OPTIONS

| SUFFIX  |                         |
|---|-------------------------|
| <b>18</b>   | Left hand hinge doors   |
| <b>R</b>  | Remote models available |
| Append suffix to model # when placing order. Ex: <b>HBR49-1-HS-18</b> |                         |

## FREEZERS

MAINTAINS PRODUCT TEMPERATURES OF -10°F.

| MODEL WIDTH              | DOOR TYPE  | MODEL #            | DOORS/<br>SHELVES | VOLTS   | HP  | AMPS | CUBIC<br>FEET | WIDTH | DEPTH | HEIGHT | CRATED<br>WEIGHT |
|--------------------------|------------|--------------------|-------------------|---------|-----|------|---------------|-------|-------|--------|------------------|
| <b>24"</b><br>1 SECTION  | SOLID      | <b>HBF12HC-1-S</b> | 1/3               | 115     | 1/2 | 5    | 11.9          | 24    | 26    | 62     | 284              |
|                          | GLASS      | <b>HBF12HC-1-G</b> |                   |         |     |      |               |       |       |        | 284              |
| <b>27"</b><br>1 SECTION  | SOLID      | <b>HBF23HC-1-S</b> | 1/2               | 115     | 3/4 | 7.5  | 22.5          | 27.25 | 33.75 | 78     | 412              |
|                          | HALF SOLID | <b>HBF23-1-HS</b>  |                   |         | 1/2 | 10.9 | 23            |       |       |        | 428              |
|                          | GLASS      | <b>HBF23HC-1-G</b> |                   |         | 3/4 | 7.5  | 22.5          |       |       |        | 446              |
|                          | HALF GLASS | <b>HBF23-1-HG</b>  |                   |         | 1/2 | 10.9 | 23            |       |       |        | 452              |
| <b>30"</b><br>1 SECTION  | SOLID      | <b>HBF27HC-1-S</b> | 1/2               | 115     | 3/4 | 7.5  | 26.57         | 30    | 33.75 | 78     | 516              |
|                          | HALF SOLID | <b>HBF27-1-HS</b>  |                   |         |     | 11.9 | 27            |       |       |        | 516              |
|                          | GLASS      | <b>HBF27-1-G</b>   |                   |         |     | 11.9 | 26.88         |       |       |        | 516              |
| <b>47"</b><br>2 SECTIONS | SOLID      | <b>HBF44-1-S</b>   | 2/6               | 115     | 3/4 | 11.9 | 44            | 47    | 33.75 | 78     | 562              |
|                          | HALF SOLID | <b>HBF44-1-HS</b>  |                   |         |     |      |               |       |       |        | 598              |
|                          | GLASS      | <b>HBF44-1-G</b>   |                   |         |     |      |               |       |       |        | 588              |
| <b>52"</b><br>2 SECTIONS | SOLID      | <b>HBF49HC-1-S</b> | 2/6               | 115     | 3/4 | 11   | 46.2          | 52    | 33.75 | 78     | 750              |
|                          | HALF SOLID | <b>HBF49-1-HS</b>  |                   |         |     | 11.9 | 49            |       |       |        | 750              |
|                          | GLASS      | <b>HBF49-1-G</b>   |                   |         |     | 11.9 | 46.2          |       |       |        | 790              |
| <b>75"</b><br>3 SECTIONS | SOLID      | <b>HBF72-1</b>     | 3/9               | 120/240 | 1   | 11.9 | 68.5          | 75    | 33.75 | 78     | 758              |
|                          | HALF SOLID | <b>HBF72-1-HS</b>  | 3/9               | 120/240 | 3/4 | 11.9 | 72            | 75    | 33.75 | 78     | 790              |
|                          | GLASS      | <b>HBF72-5-G</b>   | 3/9               | 120/240 | 1   | 11.9 | 68.5          | 75    | 33.75 | 78     | 858              |

## DUAL-TEMPS

MAINTAINS PRODUCT TEMPERATURES OF 36-38°F (REFRIGERATOR), AND -10°F (FREEZER).

| MODEL WIDTH   | DOOR TYPE  | MODEL #           | DOORS/<br>SHELVES | VOLTS | HP               | AMPS              | CUBIC<br>FEET       | WIDTH | DEPTH | HEIGHT | CRATED<br>WEIGHT |
|---|------------|-------------------|-------------------|-------|------------------|-------------------|---------------------|-------|-------|--------|------------------|
| <b>27"</b><br>2 HALF SECTIONS<br>(1 FRIDGE/1 FREEZER) | HALF SOLID | <b>HBRF23-1</b>   | 2/4               | 115   | R: 1/2<br>F: 1/3 | R: 12<br>F: 2.8   | R: 5.38<br>F: 5.46  | 27.25 | 33.75 | 78     | 448              |
| <b>52"</b><br>2 SECTIONS<br>(1 FRIDGE/1 FREEZER)      | SOLID      | <b>HBRF49-1</b>   | 2/6               | 115   | R: 1/2<br>F: 1/3 | R: 10.9<br>F: 5.8 | R: 22.57<br>F: 23.1 | 52    | 33.75 | 78     | 580              |
|   | GLASS      | <b>HBRF49-1-G</b> |                   |       |                  |                   |                     |       |       |        | 530              |
| <b>75"</b><br>3 SECTIONS<br>(FRIDGE/FREEZER)          | SOLID      | <b>HBRF72-1</b>   | 3/9               | 115   | R: 1/2<br>F: 1/3 | R: 10.9<br>F: 8.8 | 72                  | 75    | 33.75 | 78     | 715              |
|   | GLASS      | <b>HBRF72-1-G</b> |                   |       |                  |                   |                     |       |       |        | 715              |

*Depth measurement includes handles.  
For total height, add 3 or 6 inches, based on your mounting choice.*

# RI SERIES

## Compact design

to fit challenging kitchen layouts

## Heavy Duty Construction

(2" CFC and HCFC-free foamed-in place polyurethane insulation)

## Cartridge-style hinges

with 120 degree stay open feature

## LED lighting standard

## Anti-microbial door handles

## Self-closing doors

## 6" heavy duty casters standard

(3" casters or 6" leg option available at no charge when specified on order)

**HC models featuring environmentally friendly, energy efficient R290 refrigerant**



**DESIGNED TO PERFORM IN HIGH AMBIENT CONDITIONS**

**3 YEAR PARTS AND LABOR / ADDITIONAL 2 YEAR COMPRESSOR PART WARRANTY**

**MADE IN USA**



**FULL ELECTRONIC CONTROL**  
with easy to read digital display



**ANTI-MICROBIAL HANDLES**  
destroy or inhibit microorganisms,  
helping prevent the spread of germs

## AVAILABLE DOORS

- Solid (*one full-door*)
- Half Solid (*two half-doors*)
- Glass (*one full-door*)
- Half Glass (*two half-doors*)
- Half Glass, Half Solid (*two half-doors*)

## AGENCY CERTIFICATIONS





# Refrigerators

## REFRIGERATORS (REACH-IN)

MAINTAINS PRODUCT TEMPERATURES OF 36-38°F.

| MODEL WIDTH             | DOOR TYPE                | MODEL #           | DOORS/SHELVES | VOLTS | HP  | AMPS | CUBIC FEET | WIDTH | DEPTH | HEIGHT | CRATED WEIGHT |
|-------------------------|--------------------------|-------------------|---------------|-------|-----|------|------------|-------|-------|--------|---------------|
| <b>27"</b><br>1 SECTION | SOLID                    | <b>RI18HC</b>     | 1/4           | 115   | 1/4 | 5.5  | 16.85      | 27.25 | 29.25 | 69     | 322           |
|                         | HALF SOLID               | <b>RI18HC-HS</b>  |               |       |     |      |            |       |       |        | 328           |
|                         | GLASS                    | <b>RI18HC-G</b>   |               |       |     |      |            |       |       |        | 367           |
|                         | HALF GLASS               | <b>RI18HC-HG</b>  |               |       |     |      |            |       |       |        | 334           |
|                         | HALF GLASS<br>HALF SOLID | <b>RI18HC-HGS</b> |               |       |     |      |            |       |       |        | 334           |

Depth measurement includes handles.  
For total height, add 3 or 6 inches, based on your mounting choice.

## REFRIGERATORS (PASS-THRU)

MAINTAINS PRODUCT TEMPERATURES OF 36-38°F.

| MODEL WIDTH             | DOOR TYPE                | MODEL #            | DOORS/SHELVES | VOLTS | HP  | AMPS | CUBIC FEET | WIDTH | DEPTH | HEIGHT | CRATED WEIGHT |
|-------------------------|--------------------------|--------------------|---------------|-------|-----|------|------------|-------|-------|--------|---------------|
| <b>27"</b><br>1 SECTION | HALF SOLID               | <b>RID18HC-HS</b>  | 1/4           | 115   | 1/4 | 5.5  | 18.38      | 27.25 | 32.63 | 69     | 442           |
|                         | HALF GLASS<br>HALF SOLID | <b>RID18HC-HGS</b> |               |       |     |      |            |       |       |        |               |

Depth measurement includes handles.  
For total height, add 3 or 6 inches, based on your mounting choice.

### AVAILABLE OPTIONS

| SUFFIX    |                         |
|-----------|-------------------------|
| <b>18</b> | Left hand hinge doors   |
| <b>R</b>  | Remote models available |

Append suffix to model # when placing order. Ex: **RI18HC-HS-18**



### EXTERIOR FINISHES

- Stainless steel

### INTERIOR FINISHES

- Stainless steel

### AVAILABLE ACCESSORIES

- Pass-thru models available
- Additional shelves
- Wire shelf divider
- Bottle cartridge kit

### MOUNTING OPTIONS

- 6" casters (standard)
- 6" legs
- 3" casters
- Flanged/seismic feet

### AVAILABLE OPTIONS

- Left hand hinge doors
- Remote models available

# Bottom Mount Reach-In Accessories

| DESCRIPTION | UNIT(S) | PART NUMBER |
|-------------|---------|-------------|
|-------------|---------|-------------|

| SHELVING / ORGANIZERS              |                 |             |
|------------------------------------|-----------------|-------------|
| Epoxy Coated Wire Shelf            | RB/FB/HBR/HBF23 | 403-900D-02 |
| Epoxy Coated Wire Shelf            | RB/FB/HBR/HBF27 | 403-871D-02 |
| Epoxy Coated Wire Shelf            | RB/FB/HBR/HBF49 | 403-873D-02 |
| Epoxy Coated Wire Shelf            | RB/FB/HBR/HBF72 | 403-874D-02 |
| Epoxy Coated Wire Shelf            | RI18            | 403-463D    |
| Shelf Clip                         | RB/FB/HBR/HBF   | 403-169A    |
| Flat Wine Rack with Bottle Support | RB/FB/HBR23     | 403-928D-03 |
| Flat Wine Rack with Bottle Support | RB/FB/HBR27     | 403-929D-03 |
| Flat Wine Rack with Bottle Support | RB/FB/HBR49     | 403-930D-03 |
| Flat Wine Rack with Bottle Support | RB/FB/HBR72     | 403-931D-03 |
| Wire Divider                       | RI Series       | 403-719C    |

| MOUNTING                |   |               |
|-------------------------|---|---------------|
| 3" Stem w/Brake         | RB/FB/HBR/HBF (per caster-2 required per cabinet) | 401-633A      |
| 3" Stem                 | RB/FB/HBR/HBF (per caster-2 required per cabinet) | 401-634A      |
| 6" Caster               | RB/FB/HBR/HBF                                     | 61C01-014D-01 |
| 6" Seismic/Flanged Legs | RB/FB/HBR/HBF Series (set of four)                | 00C31-055A    |
| 3" Caster               | RI Series   | 401-695B      |
| 3" Caster With Brake    | RI Series   | 401-696B      |
| 6" Caster               | RI Series   | 401-275A      |
| 6" Caster With Brake    | RI Series   | 401-276A      |
| 6" Black Legs           | RI Series   | 401-405A      |

| ADDITIONAL ACCESSORIES |                             |          |
|------------------------|-----------------------------|----------|
| Door Lock              | RB/FB/HBR/HBF (SOLID DOORS) | 401-274A |

| TRAY SLIDE KITS                             |                  |                   |
|---|------------------|-------------------|
| KIT #3 STAINLESS STEEL UNIVERSAL TRAY SLIDE |                  |                   |
| 8 SETS PER 1/2 SECTION                      | RB/FB/HBR/HBF 23 | 61C08-038A-02 (2) |
|   | RB/FB/HBR/HBF 49 | 61C08-038A-01 (2) |







# **SPEC LINE**

**SPECIALTY UNITS READY FOR ANY LAYOUT AND PERFORMANCE SOLUTION**

# P SERIES

**Stainless steel breakers**

**LED lighting**

**Full electronic control**

**Self-closing doors**

with 120° stay-open feature, on cam-lift hinges

**Expansion valve technology**

Freezer only

**Anti-microbial door handles**

**Door locks standard**

Solid doors only (optional on glass door models)

**Magnetic gasket attached to each door**

for positive seal

**6" adjustable legs**

(3" casters or 6" caster option available at no charge when specified on order)

**3 epoxy coated wire shelves**

per section

**Removable access panel**

for ease of service and maintenance



**MAXIMUM RESISTANCE TO WEAR AND TEAR WITH STAINLESS STEEL BREAKER CAPS AND DOOR LINERS**

**MODULAR INTERIOR GIVES ULTIMATE FLEXIBILITY FOR SHELF AND SLIDE COMBINATIONS**

**3 YEAR PARTS AND LABOR WARRANTY**



**TRAY SLIDES A AVAILABLE**  
holds one 18x26" or two 14x18"



**TRAY SLIDES A/C AVAILABLE**  
hold one 18x26", or two 14x18", or two 12x20"

**AVAILABLE DOORS**

- Solid (*one full-door*)
- Half Solid (*two half-doors*)
- Glass (*one full-door*)
- Half Glass (*two half-doors*)

**CONFIGURATIONS**

- Reach-in
- Pass-thru
- Roll-in / Roll-thru / Extra-tall
- Dual-temp

# Spec Line Refrigeration



## EXTERIOR FINISHES

- Stainless steel

## INTERIOR FINISHES

- Corrosion-resistant aluminum
- Stainless steel

## AGENCY CERTIFICATIONS



## AVAILABLE ACCESSORIES

- Additional shelves
- Tray slide kits
- Glass door locks
- Stainless steel shelves
- Chrome-plated shelves
- Kick plate

## AVAILABLE OPTIONS

- Left hand hinge doors
- Remote models available

## MOUNTING OPTIONS

- 6" legs (standard)
- 6" casters
- 3" casters
- Flanged/seismic feet

# P SERIES

## REFRIGERATORS - REACH IN

MAINTAINS PRODUCT TEMPERATURES OF 36-38°F.

| MODEL WIDTH               | DOOR TYPE  | MODEL #  | DOORS/SHELVES | VOLTS | HP  | AMPS | CUBIC FEET | WIDTH | DEPTH | HEIGHT | CRATED WEIGHT |
|---------------------------|------------|----------|---------------|-------|-----|------|------------|-------|-------|--------|---------------|
| <b>26.5"</b><br>1 SECTION | SOLID      | PR1-1AS  | 1/3           | 115   | 1/3 | 9.8  | 20.9       | 26.50 | 34.63 | 77.75  | 320           |
|                           | HALF SOLID | PR1-1AHS | 2/3           | 115   | 1/3 | 9.8  | 20.9       | 26.50 | 34.63 | 77.75  | 320           |
|                           | GLASS      | PR1-1BG  | 1/3           | 115   | 1/3 | 9.2  | 20.6       | 26.50 | 33.38 | 77.75  | 406           |
|                           | HALF GLASS | PR1-1BHG | 2/6           | 115   | 1/3 | 9.2  | 20.6       | 26.50 | 33.38 | 77.75  | 398           |
| <b>52"</b><br>2 SECTION   | SOLID      | PR2-1AS  | 2/6           | 115   | 1/3 | 10.7 | 43.3       | 52.13 | 34.63 | 77.75  | 483           |
|                           | HALF SOLID | PR2-1AHS | 4/6           | 115   | 1/3 | 10.7 | 44.3       | 52.13 | 34.63 | 77.75  | 483           |
|                           | GLASS      | PR2-1BG  | 2/6           | 115   | 1/2 | 12   | 43.3       | 52.13 | 33.38 | 77.75  | 600           |
|                           | HALF GLASS | PR2-1BHG | 4/6           | 115   | 1/2 | 12   | 43.3       | 52.13 | 33.38 | 77.75  | 624           |
| <b>78"</b><br>3 SECTIONS  | SOLID      | PR3-1AS  | 3/9           | 115   | 1/2 | 13.8 | 67.9       | 77.75 | 34.63 | 77.75  | 625           |
|                           | HALF SOLID | PR3-1AHS | 6/9           |       | 1/2 | 13.8 | 67.9       |       |       |        |               |
|                           | GLASS      | PR3-1BG  | 3/9           | 115   | 1/2 | 13.8 | 67.9       | 77.75 | 33.38 | 77.75  | 841           |
|                           | HALF GLASS | PR3-1BHG | 6/9           |       | 1/2 | 13.8 | 67.9       |       |       |        |               |

Depth measurement includes handles.  
For total height, add 3 or 6 inches, based on your mounting choice.

## REFRIGERATORS - PASS-THRU

MAINTAINS PRODUCT TEMPERATURES OF 36-38°F.

| MODEL WIDTH               | DOOR TYPE  | MODEL #   | DOORS/SHELVES | VOLTS | HP  | AMPS | CUBIC FEET | WIDTH | DEPTH | HEIGHT | CRATED WEIGHT |
|---------------------------|------------|-----------|---------------|-------|-----|------|------------|-------|-------|--------|---------------|
| <b>26.5"</b><br>1 SECTION | SOLID      | PRD1-1AS  | 2/3           | 115   | 1/3 | 9.8  | 22.2       | 26.50 | 38.38 | 77.75  | 370           |
|                           | HALF SOLID | PRD1-1AHS | 4/3           | 115   | 1/3 | 9.8  | 22.2       | 26.50 | 38.38 | 77.75  | 370           |
|                           | GLASS      | PRD1-1BG  | 2/3           | 115   | 1/3 | 9.2  | 22.2       | 26.50 | 35.88 | 77.75  | 471           |
|                           | HALF GLASS | PRD1-1BHG | 4/3           | 115   | 1/3 | 9.2  | 22.2       | 26.50 | 35.88 | 77.75  | 436           |
| <b>52"</b><br>2 SECTION   | SOLID      | PRD2-1AS  | 4/6           | 115   | 1/3 | 10.7 | 48         | 52.13 | 38.38 | 77.75  | 682           |
|                           | HALF SOLID | PRD2-1AHS | 8/6           | 115   | 1/3 | 10.7 | 48         | 52.13 | 38.38 | 77.75  | 652           |
|                           | GLASS      | PRD2-1BG  | 4/6           | 115   | 1/3 | 12.8 | 48         | 52.13 | 35.88 | 77.75  | 738           |
|                           | HALF GLASS | PRD2-1BHG | 8/6           | 115   | 1/3 | 11.9 | 48         | 52.13 | 35.88 | 77.75  | 738           |
| <b>78"</b><br>3 SECTIONS  | SOLID      | PRD3-1AS  | 6/9           | 115   | 1/2 | 12   | 75.1       | 77.75 | 38.38 | 77.75  | 950           |
|                           | HALF SOLID | PRD3-1AHS | 12/9          | 115   | 1/2 | 12   | 75.1       | 77.75 | 38.38 | 77.75  | 950           |
|                           | GLASS      | PRD3-1BG  | 6/9           | 115   | 1/2 | 12   | 75.1       | 77.75 | 35.88 | 77.75  | 912           |
|                           | HALF GLASS | PRD3-1BHG | 12/9          | 115   | 1/2 | 12   | 75.1       | 77.75 | 35.88 | 77.75  | 912           |

Depth measurement includes handles.  
For total height, add 3 or 6 inches, based on your mounting choice.



# Spec Line Refrigeration

## REFRIGERATORS - ROLL-IN

MAINTAINS PRODUCT TEMPERATURES OF 36-38°F.

| MODEL WIDTH               | DOOR TYPE | MODEL #  | DOORS/<br>SHELVES | VOLTS | HP  | AMPS | CUBIC<br>FEET | WIDTH | DEPTH | HEIGHT | CRATED<br>WEIGHT |
|---------------------------|-----------|----------|-------------------|-------|-----|------|---------------|-------|-------|--------|------------------|
| <b>36.5"</b><br>1 SECTION | SOLID     | PR11-1AS | N/A               | 115   | 1/3 | 9.5  | 35            | 36.5  | 36.13 | 84     | 381              |
|                           |           | PR11XT   |                   |       |     |      |               |       |       | 89.63  | 390              |
| <b>69"</b><br>2 SECTION   | SOLID     | PR12-1AS | N/A               | 115   | 1/3 | 13   | 44.2          | 68.88 | 36.13 | 84     | 600              |
|                           |           | PR12XT   |                   |       |     |      |               |       |       | 89.63  | 630              |

## REFRIGERATORS - ROLL-THRU

MAINTAINS PRODUCT TEMPERATURES OF 36-38°F.

| MODEL WIDTH               | DOOR TYPE | MODEL #  | DOORS/<br>SHELVES | VOLTS | HP  | AMPS | CUBIC<br>FEET | WIDTH | DEPTH | HEIGHT | CRATED<br>WEIGHT |
|---------------------------|-----------|----------|-------------------|-------|-----|------|---------------|-------|-------|--------|------------------|
| <b>36.5"</b><br>1 SECTION | SOLID     | PRT1-1AS | N/A               | 115   | 1/3 | 11.8 | 35            | 36.5  | 39.88 | 84     | 420              |
| <b>69"</b><br>2 SECTION   | SOLID     | PRT2-1AS | N/A               | 115   | 1/2 | 13   | 71            | 68.88 | 39.88 | 84     | 683              |

*Depth measurement includes handles.*

## DUAL-TEMPS - REACH-IN

MAINTAINS PRODUCT TEMPERATURES OF 36-38°F (REFRIGERATOR), AND -10°F (FREEZER).

| MODEL WIDTH   | DOOR TYPE  | MODEL #        | DOORS/<br>SHELVES | VOLTS | HP             | AMPS            | CUBIC<br>FEET    | WIDTH | DEPTH | HEIGHT | CRATED<br>WEIGHT |
|---|------------|----------------|-------------------|-------|----------------|-----------------|------------------|-------|-------|--------|------------------|
| <b>27"</b><br>2 HALF SECTIONS<br>(1 FRIDGE/1 FREEZER) | HALF SOLID | PRF12-12HC-1HS | 2/4               | 115   | R:1/6<br>F:1/2 | R:3<br>F:7      | R:8.56<br>F:8.56 | 26.63 | 34.63 | 77.75  | 438              |
| <b>52"</b><br>2 SECTIONS<br>(1 FRIDGE/1 FREEZER)      | SOLID      | PRF-24-241AS   | 2/6               | 115   | R:1/4<br>F:1/2 | R:6.4<br>F:11.1 | R:23.1<br>F:23.1 | 52    | 33    | 78.5   | 701              |
| <b>78"</b><br>2 HALF SECTIONS<br>(2 FRIDGE/1 FREEZER) | SOLID      | PRF48-241AS    | 3/9               | 115   | R:1/3<br>F:1/2 | R:9.4<br>F:10.6 | R:46.6<br>F:23.1 | 78    | 33    | 78.5   | 946              |

*Depth measurement includes handles.*

*For total height, add 3 or 6 inches, based on your mounting choice.*

# P SERIES

**Stainless steel breakers**

**Full electronic control**

**Self-closing doors**

with 120° stay-open feature, on cam-lift hinges

**Built-in adjustable humidity control**

**Anti-microbial door handles**

**Door locks standard**

Solid doors only (optional on glass door models)

**Magnetic gasket attached to each door**

for positive seal

**6" adjustable legs**

(3" casters or 6" caster option available at no charge when specified on order)

**3 chrome-plated wire shelves**

per section

**Removable access panel**

for ease of service and maintenance

**Temperature range from 80-180° F**



**MAXIMUM RESISTANCE TO WEAR AND TEAR WITH STAINLESS STEEL BREAKER CAPS AND DOOR LINERS**

**MODULAR INTERIOR GIVES MAXIMUM FLEXIBILITY FOR SHELF AND SLIDE COMBINATIONS**

**3 YEAR PARTS AND LABOR WARRANTY**



**TRAY SLIDES A AVAILABLE**  
holds one 18x26" or two 14x18"



**TRAY SLIDES A/C AVAILABLE**  
hold one 18x26", or two 14x18", or two 12x20"

**AVAILABLE DOORS**

- Solid (*one full-door*)
- Half Solid (*two half-doors*)
- Glass (*one full-door*)
- Half Glass (*two half-doors*)

**CONFIGURATIONS**

- Reach-in
- Pass-thru
- Roll-in / Roll-thru / Extra-tall

# Spec Line Warming Cabinets



## EXTERIOR FINISHES

- Stainless steel

## INTERIOR FINISHES

- Corrosion-resistant aluminum
- Stainless steel

## AGENCY CERTIFICATIONS



## AVAILABLE ACCESSORIES

- Additional shelves
- Tray slide kits
- Glass door locks
- Stainless steel shelves
- Kick plate

## AVAILABLE OPTIONS

- Left hand hinge doors

## MOUNTING OPTIONS

- 6" legs (standard)
- 6" casters
- 3" casters
- Flanged/seismic feet

# P SERIES

## WARMING CABINETS - REACH IN

| MODEL WIDTH               | DOOR TYPE  | MODEL #         | DOORS/SHELVES | VOLTS   | WATTS | AMPS | CUBIC FEET | WIDTH | DEPTH | HEIGHT | CRATED WEIGHT |
|---------------------------|------------|-----------------|---------------|---------|-------|------|------------|-------|-------|--------|---------------|
| <b>26.5"</b><br>1 SECTION | SOLID      | <b>PH1-1S</b>   | 1/3           | 208-240 | 1500  | 6.3  | 21.5       | 26.50 | 35    | 77.75  | 320           |
|                           | HALF SOLID | <b>PH1-1HS</b>  | 2/3           | 208-240 | 1500  | 6.3  | 21.5       | 26.50 | 35    | 77.75  | 320           |
|                           | GLASS      | <b>PH1-1BG</b>  | 1/3           | 208-240 | 1500  | 6.3  | 21.5       | 26.50 | 33.38 | 77.75  | 320           |
|                           | HALF GLASS | <b>PH1-1BHG</b> | 2/3           | 208-240 | 1500  | 6.3  | 21.5       | 26.50 | 33.38 | 77.75  | 320           |
| <b>52"</b><br>2 SECTIONS  | SOLID      | <b>PH2-1S</b>   | 4/6           | 208-240 | 1500  | 13   | 46.5       | 52.13 | 35    | 77.75  | 440           |
|                           | HALF SOLID | <b>PH2-1HS</b>  | 2/6           | 208-240 | 1500  | 13   | 46.5       | 52.13 | 35    | 77.75  | 590           |
|                           | GLASS      | <b>PH2-1BG</b>  | 2/6           | 208-240 | 1500  | 13   | 46.5       | 52.13 | 33.38 | 77.75  | 440           |
|                           | HALF GLASS | <b>PH2-1BHG</b> | 4/6           | 208-240 | 1500  | 13   | 46.5       | 52.13 | 33.38 | 77.75  | 440           |

*Depth measurement includes handles.  
For total height, add 3 or 6 inches, based on your mounting choice.*



# Spec Line Warming Cabinets

## WARMING CABINETS - PASS-THRU

| MODEL WIDTH               | DOOR TYPE  | MODEL #     | DOORS/<br>SHELVES | VOLTS   | WATTS | AMPS | CUBIC<br>FEET | WIDTH | DEPTH | HEIGHT | CRATED<br>WEIGHT |
|---------------------------|------------|-------------|-------------------|---------|-------|------|---------------|-------|-------|--------|------------------|
| <b>26.5"</b><br>1 SECTION | SOLID      | PH1-1S-PT   | 2/3               | 208-240 | 1500  | 6.3  | 21.5          | 26.50 | 38.38 | 77.75  | 320              |
|                           | HALF SOLID | PH1-1HS-PT  | 1/3               | 208-240 | 1500  | 6.3  | 21.5          | 26.50 | 38.38 | 77.75  | 320              |
|                           | GLASS      | PH1-1BG-PT  | 1/3               | 208-240 | 1500  | 6.3  | 21.5          | 26.50 | 35.88 | 77.75  | 320              |
|                           | HALF GLASS | PH1-1BHG-PT | 2/3               | 208-240 | 1500  | 6.3  | 21.5          | 26.50 | 35.88 | 77.75  | 320              |
| <b>52"</b><br>2 SECTIONS  | SOLID      | PH2-1S-PT   | 2/6               | 208-240 | 1500  | 13   | 46.5          | 52.13 | 38.38 | 77.75  | 440              |
|                           | HALF SOLID | PH2-1HS-PT  | 2/6               | 208-240 | 1500  | 13   | 46.5          | 52.13 | 38.38 | 77.75  | 440              |
|                           | GLASS      | PH2-1BG-PT  | 2/6               | 208-240 | 1500  | 13   | 46.5          | 52.13 | 35.88 | 77.75  | 590              |
|                           | HALF GLASS | PH2-1BHG-PT | 2/6               | 208-240 | 1500  | 13   | 46.5          | 52.13 | 35.88 | 77.75  | 590              |

*Depth measurement includes handles.  
For total height, add 3 or 6 inches, based on your mounting choice.*

## WARMING CABINETS - ROLL-THRU

| MODEL WIDTH  | DOOR TYPE | MODEL #    | DOORS/<br>SHELVES | VOLTS   | WATTS | AMPS | CUBIC<br>FEET | WIDTH | DEPTH | HEIGHT | CRATED<br>WEIGHT |
|--------------|-----------|------------|-------------------|---------|-------|------|---------------|-------|-------|--------|------------------|
| <b>36.5"</b> | SOLID     | PH11-1S-PT | 2                 | 208-240 | 1500  | 6.3  | 33.6          | 36.50 | 36.13 | 84     | 325              |
|              | SOLID     | PH11-2S-PT | 4                 | 208-240 | 1500  | 6.3  | 36.2          | 36.50 | 40.63 | 84.25  | 325              |
| <b>69"</b>   | SOLID     | PH12-1S-PT | 4                 | 208-240 | 1500  | 13   | 67.2          | 68.88 | 36.13 | 84     | 540              |
|              | SOLID     | PH12-2S-PT | 4                 | 208-240 | 1500  | 13   | 72.4          | 68.13 | 40.63 | 84.25  | 540              |

*Depth measurement includes handles.*

# Cross-Temp™ Series

**NEW**

**Easily converts from refrigerator to freezer**  
exclusive Beverage-Air Cross-Temp™ technology

**Temperature range of -15 to 40° F**

**Modulates coil temp to achieve desired set point**  
while achieving maximum energy efficiency

**Single cabinet configurable to all menu initiatives**

**Intuitive compressor**  
adjusts for optimal effectiveness in high-use situations

**Quicker pull-down**  
for both air and product temperatures

**Improved product stability**

**Smart-defrost**

**Expansion valve**

**Rapid-recovery after defrost**  
consistent product temperature and ensures food quality

**Door locks standard**  
Solid doors only (optional on glass door models)

**Featuring environmentally friendly  
energy efficient R290 refrigerant**



**EASILY CONVERTS FROM  
REFRIGERATOR TO FREEZER**

**VARIABLE SPEED COMPRESSOR TECHNOLOGY  
ACHIEVES 30% MORE ENERGY EFFICIENCY  
COMPARED TO A SINGLE-SPEED**



**EASY-TO-USE CONTROLLER**  
to quickly adjust set points



**VARIABLE SPEED SYSTEM**  
modulates coil temp

**AVAILABLE DOORS**

- Solid (one full-door)
- Half Solid (two half-doors)
- Glass (one full-door)
- Half Glass (two half-doors)

**AGENCY CERTIFICATIONS**



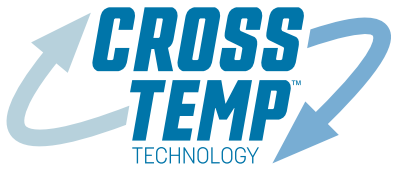

**Easily converts from refrigerator to freezer**  
with Beverage-Air's exclusive Cross-Temp™ technology

## Convertible Refrigeration



### EXTERIOR FINISHES

- Stainless steel front with continuous coil coated sides
- Stainless steel sides/front

### INTERIOR FINISHES

- Corrosion resistant aluminum
- Stainless steel

### AVAILABLE ACCESSORIES

- Tray Slides
- Additional shelves

### MOUNTING OPTIONS

- 6" casters (standard)
- 6" legs
- 3" casters (single section only)
- Flanged/seismic feet

### AVAILABLE OPTIONS

- Left hand hinge doors



# Cross-Temp™ Series

**NEW**

## 1 SECTION & COMPRESSOR

CAN CONVERT BETWEEN FREEZER AND REFRIGERATOR TEMPERATURES FROM -10° TO 38°F

| MODEL WIDTH             | DOOR TYPE  | MODEL #          | DOORS/SHELVES | VOLTS | HP  | AMPS | CUBIC FEET | WIDTH | DEPTH | HEIGHT | CRATED WEIGHT |
|-------------------------|------------|------------------|---------------|-------|-----|------|------------|-------|-------|--------|---------------|
| <b>26"</b><br>1 SECTION | SOLID      | <b>CT1HC-1S</b>  | 1/3           | 115   | 4/5 | 8    | 23.1       | 26    | 33.63 | 78.5   | 326           |
|                         | HALF SOLID | <b>CT1HC-1HS</b> | 2/3           |       |     |      |            |       |       |        | 324           |
|                         | GLASS      | <b>CT1HC-1G</b>  | 1/3           | 115   | 4/5 | 8    | 23.1       |       |       |        | 429           |
|                         | HALF GLASS | <b>CT1HC-1HG</b> | 2/3           |       |     |      |            |       |       |        | 356           |

Depth measurement includes handles.  
For total height, add 3 or 6 inches, based on your mounting choice.

## 2 SECTIONS & COMPRESSORS

CAN CONVERT BETWEEN FREEZER AND REFRIGERATOR TEMPERATURES FROM -15° TO 38°F

| MODEL WIDTH                           | DOOR TYPE  | MODEL #              | DOORS/SHELVES | VOLTS | HP               | AMPS             | CUBIC FEET   | WIDTH | DEPTH | HEIGHT | CRATED WEIGHT |
|---------------------------------------|------------|----------------------|---------------|-------|------------------|------------------|--------------|-------|-------|--------|---------------|
| <b>27"</b><br>2 SECTIONS<br>(STACKED) | HALF SOLID | <b>CT12-12HC-1HS</b> | 2/4           | 115   | 1: 1/3<br>2: 1/3 | 1: 5.8<br>2: 5.8 | 1: 9<br>2: 9 | 26.63 | 34.63 | 77.75  | 438           |

Depth measurement includes handles.  
For total height, add 3 or 6 inches, based on your mounting choice.

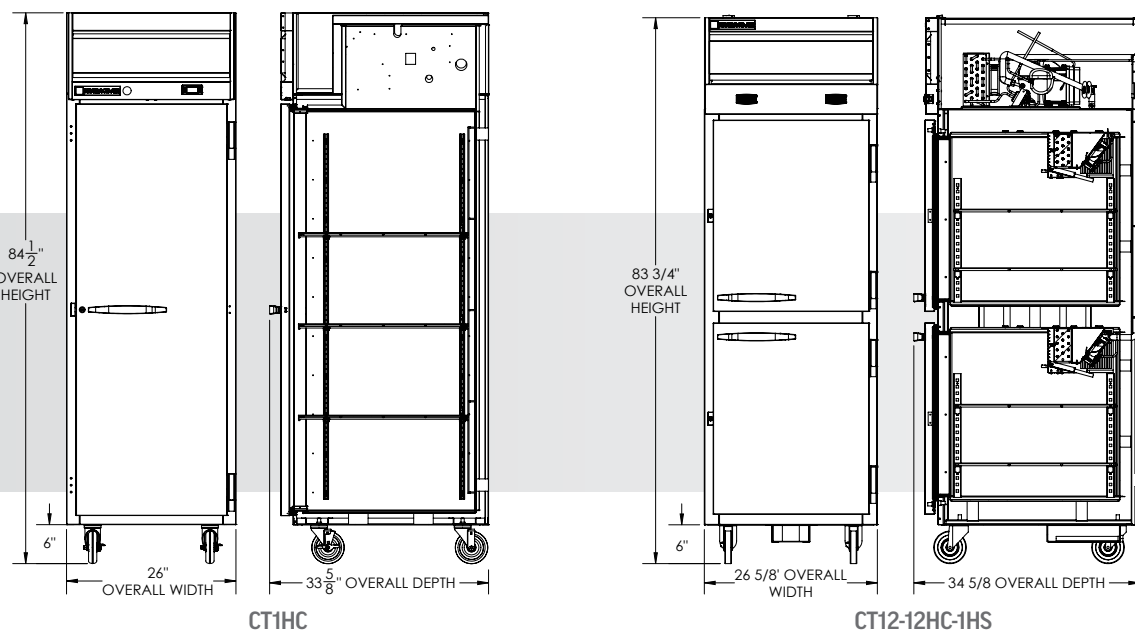

CT1HC

CT12-12HC-1HS



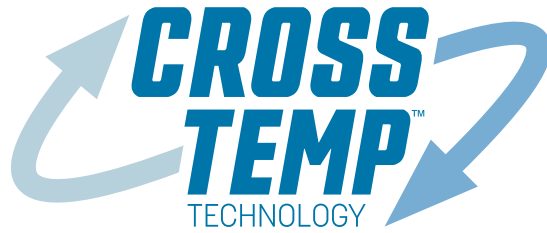

### **WHAT IS CROSS-TEMP™ TECHNOLOGY?**

New from Beverage-Air, Cross-Temp™ technology allows the user to easily switch the unit back and forth from refrigerator to freezer as needed, with a range of -15° to 40°F.

### **THE PURPOSE CROSS-TEMP™**

Simply put, Cross-Temp technology lets the user get the most flexibility from the unit, by letting them switch from fridge to freezer as their menus change with the seasons and initiatives, including ice-cream storage.

### **IS CROSS-TEMP ENERGY EFFICIENT?**

The Cross-Temp™ units are intuitive and self-adjust for optimal effectiveness based on usage. Even in high-usage situations, Cross-Temp units adjust to maintain maximum energy efficiency.

### **HOW LONG DOES THE CONVERSION TAKE?**

On average, a Cross-Temp unit can convert from refrigerator to freezer or vice versa, in under an hour. (Conditions and results will vary)



# BLAST CHILLERS/FREEZERS

- Compact construction**
- Electronic control board display**
- Custom chill/freeze cycles**
- Core temperature probe**
- Manual defrost**
- Insulation is CFC and HCFC free, high density polyurethane**
- R404A refrigeration**
- Self-contained refrigeration**



**3 YEAR PARTS AND LABOR / ADDITIONAL 2 YEAR COMPRESSOR PART WARRANTY**  
**AUTOMATIC PRODUCT STORING AT END OF CYCLE**  
**UP TO 99 CUSTOM PROGRAMMABLE CYCLES**



**CORE PROBE**  
measures product temperature



**ELECTRONIC CONTROL DISPLAY**  
intuitive programmable display

#### EXTERIOR FINISHES

- Stainless steel

#### INTERIOR FINISHES

- Stainless steel

#### AGENCY CERTIFICATIONS



## BLAST CHILLER/FREEZERS

| MODEL WIDTH | MODEL # | VOLTS   | AMPS | CUBIC FEET | WIDTH | DEPTH | HEIGHT | CRATED WEIGHT | PAN CAPACITY | CHILLING CYCLE             | CHILLING CAPACITY |
|-------------|---------|---------|------|------------|-------|-------|--------|---------------|--------------|----------------------------|-------------------|
| <b>22"</b>  | CF031AG | 115-120 | 9.9  | 7.3        | 22.05 | 27.6  | 20.47  | 104           | 3            | 194° to 37° F (90 minutes) | 17.6 lbs          |
|             |         |         |      |            |       |       |        |               |              | 194° to 0° F (240 minutes) | 11 lbs            |

*Depth measurement includes handles.  
Height measurement includes mounting height.*

## BLAST CHILLER/FREEZERS

| MODEL WIDTH | MODEL # | VOLTS | AMPS | CUBIC FEET | WIDTH | DEPTH | HEIGHT | CRATED WEIGHT | PAN CAPACITY | CHILLING CYCLE             | CHILLING CAPACITY |
|-------------|---------|-------|------|------------|-------|-------|--------|---------------|--------------|----------------------------|-------------------|
| <b>31"</b>  | BF051AG | 230   | 6.7  | 13.9       | 31.1  | 27.56 | 33     | 304           | 5            | 194° to 37° F (90 minutes) | 40 lbs            |
|             |         |       |      |            |       |       |        |               |              | 194° to 0° F (240 minutes) | 26 lbs            |

**Self-closing doors**  
with still position at 100 degrees

**Ergonomic handles**

**6" casters standard**

*Depth measurement includes handles.  
Height measurement includes mounting height.*

### WHAT IS BLAST CHILLING AND FREEZING?

Blast Chilling extracts the heat out of food, rapidly lowering the temperature. Department of Health guidelines require that all food temperatures be reduced from 150°F to 38°F degrees within a 90 minute period to keep food out of the "danger zone" of 145°F to 46°F, where bacteria multiplies fast.

Blast freezing rapidly lowers food temperatures from 150°F to 0°F vs. chilling temperatures above.

### WHAT IS SOFT CHILL?

The Soft Chill cycle is ideal for the rapid, but gentle chilling of any dish (i.e., rice, pasta, fish, and fruit). This cycle brings the temperature of the food down while maintaining positive air temperatures of 37°F or above. This prevents ice crystals from forming that can damage the structure of delicate foods and allows for delicate foods to keep their brilliant colors.

### WHAT IS HARD CHILL?

The Hard Chill cycle is ideal for chilling "standard products" such as cooked meat, lasagna, and individually portioned meals.

### BENEFITS OF BLAST CHILLING

- Always serve fresh, top quality products
- Color, texture, and nutritional value are locked in
- The fast cooling process of blast chilling dramatically reduces bacteria reproduction, minimizing food spoilage
- Delicate foods like rice, pasta, fish, and fruit are protected Kitchen Efficiency - Saves Time & Money
- Allows advance food prep by preparing larger batches that can be refrigerated or frozen for later use
- Can enhance profits by increasing product capacity and reducing food waste
- Allows left over food from serving line to be quickly and safely chilled for later use
- Use Blast Chiller/Freezers on raw or cooked food

# WILLIAMS BLAST CHILLERS

**Polished stainless steel front, sides, and door maintain**

an attractive appearance after years of heavy use

**Stainless steel interior**

**Self-closing door**

**Easy-to-replace balloon gasket**

prevents cold air from escaping

**Door heater to prevent condensation**

from forming on the cabinet front

**Unique 1-2-3 microprocessor control panel initiates blast cycles**

in three simple steps

**Built-in alarms**

**Temperature probes or a digital timer**

can control the chilling process

**Programmable with two preset chilling times**

for specific food products



**DOOR HEATER IS PROVIDED AS STANDARD TO PREVENT CONDENSATION FROM FORMING ON THE CABINET FRONT**

**STAINLESS STEEL EXTERIOR AND INTERIOR TO MAINTAIN AN ATTRACTIVE APPEARANCE AFTER YEARS OF HEAVY USE**



**FRONT BREATHING**  
on reach-in and undercounter models



**1-2-3 MICROPROCESSOR**  
control panel

**AVAILABLE DOORS**

- Solid

**AGENCY CERTIFICATIONS**



## BLAST CHILLER/FREEZERS

| MODEL WIDTH  | MODEL #       | DOORS/<br>SHELVES | VOLTS   | HP    | AMPS | CUBIC<br>FEET | WIDTH | DEPTH | HEIGHT | CRATED<br>WEIGHT | CHILLING CYCLE             | CHILLING<br>CAPACITY |
|--------------|---------------|-------------------|---------|-------|------|---------------|-------|-------|--------|------------------|----------------------------|----------------------|
| <b>28"</b>   | <b>WBC35</b>  | 1/5               | 208-230 | 3/4   | 7    | 35            | 28    | 32    | 35     | 275              | 160° to 38° F (90 minutes) | 35 lbs               |
| <b>57"</b>   | <b>WBC60</b>  | 1/7               | 208-230 | 1/3   | 7.1  | 70            | 57    | 34    | 33.5   | 362              | 160° to 38° F (90 minutes) | 70 lbs               |
| <b>35.5"</b> | <b>WBC75</b>  | 1/12              | 208     | 1 1/2 | 15   | 75            | 35.5  | 36    | 77.5   | 595              | 160° to 38° F (90 minutes) | 75 lbs               |
| <b>43"</b>   | <b>WBC110</b> | 1/12              | 208-230 | 1 1/2 | 8.6  | 110           | 43.38 | 40.63 | 81     | 747              | 160° to 38° F (90 minutes) | 110 lbs              |

*Depth measurement includes handles.  
Height measurement includes mounting height.*



### EXTERIOR FINISHES

- Stainless steel

### INTERIOR FINISHES

- Stainless steel

# Spec Line Accessories

| DESCRIPTION  | UNIT(S)  | PART NUMBER       |
|--|--|-------------------|
| <b>SHELVING / ORGANIZERS</b>   |  |                   |
| Epoxy Coated Wire Shelf  | P Series Flat Shelving                               | 403-507D          |
| All Epoxy Coated Shelves   | RI18-HS/HG   | 403-719C          |
| Shelf Clip   | P Series   | 403-077A-A        |
| Epoxy Coated Wire Shelf  | Cross-Temp Flat Shelving 1 Door Unit                 | 403-889D-01       |
| S/S Shelves  | Cross-Temp Flat Shelving 1 Door Unit                 | 403-889D-04       |
| Shelf Clip   | Any Cross-Temp Unit                                  | 403-169A          |
| <b>MOUNTING</b>  |  |                   |
| 6" Caster  | P Series (set of four)                               | 61C01-001A        |
| 3" Caster  | P Series (set of four)                               | 61C01-013A        |
| 3.2" Casters   | BF051AG  | 920596            |
| 6" Seismic/Flanged Legs  | P Series (set of four)                               | 00C31-055A        |
| 6" Caster  | Any Cross-Temp Unit (set of four)                    | 61C01-001A        |
| 3" Caster  | Any Cross-Temp Unit (set of four)                    | 61C01-013A        |
| 6" Black Leg   | Any Cross-Temp Unit ( set of four)                   | 58B02S001A        |
| 6" Seismic/Flanged Legs  | Any Cross-Temp Unit (set of four)                    | 00C31-055A        |
| <b>ADDITIONAL ACCESSORIES</b>  |  |                   |
| Door Lock  | P Series, Cross-Temp Series - Glass Doors (per door) | 61C11S032A        |
| <b>TRAY SLIDE KITS</b>   |  |                   |
| <b>TYPE "A" STANDARD &amp; EXTRA WIDE UNITS</b>                                    |  |                   |
| 1 tray slide set for:<br>one 18x26" pan, or two 14x18" pans                        | P-Series, Cross-Temp Series                          | 10601211S         |
| <b>TYPE "A/C" STANDARD &amp; EXTRA WIDE UNITS</b>                                  |  |                   |
| 1 tray slide set for:<br>one 18x26" pan, or two 14x18" pans,<br>or two 12x20" pans | P-Series, Cross-Temp Series                          | 10601201S         |
| <b>KIT #4 EPOXY COATED WIRE ROD TRAY SLIDE</b>                                     |  |                   |
| 19 SETS PER 1/2 SECTION  | Cross-Temp Series                                    | 61C31-251A-01 (2) |

# P-Series Schematics

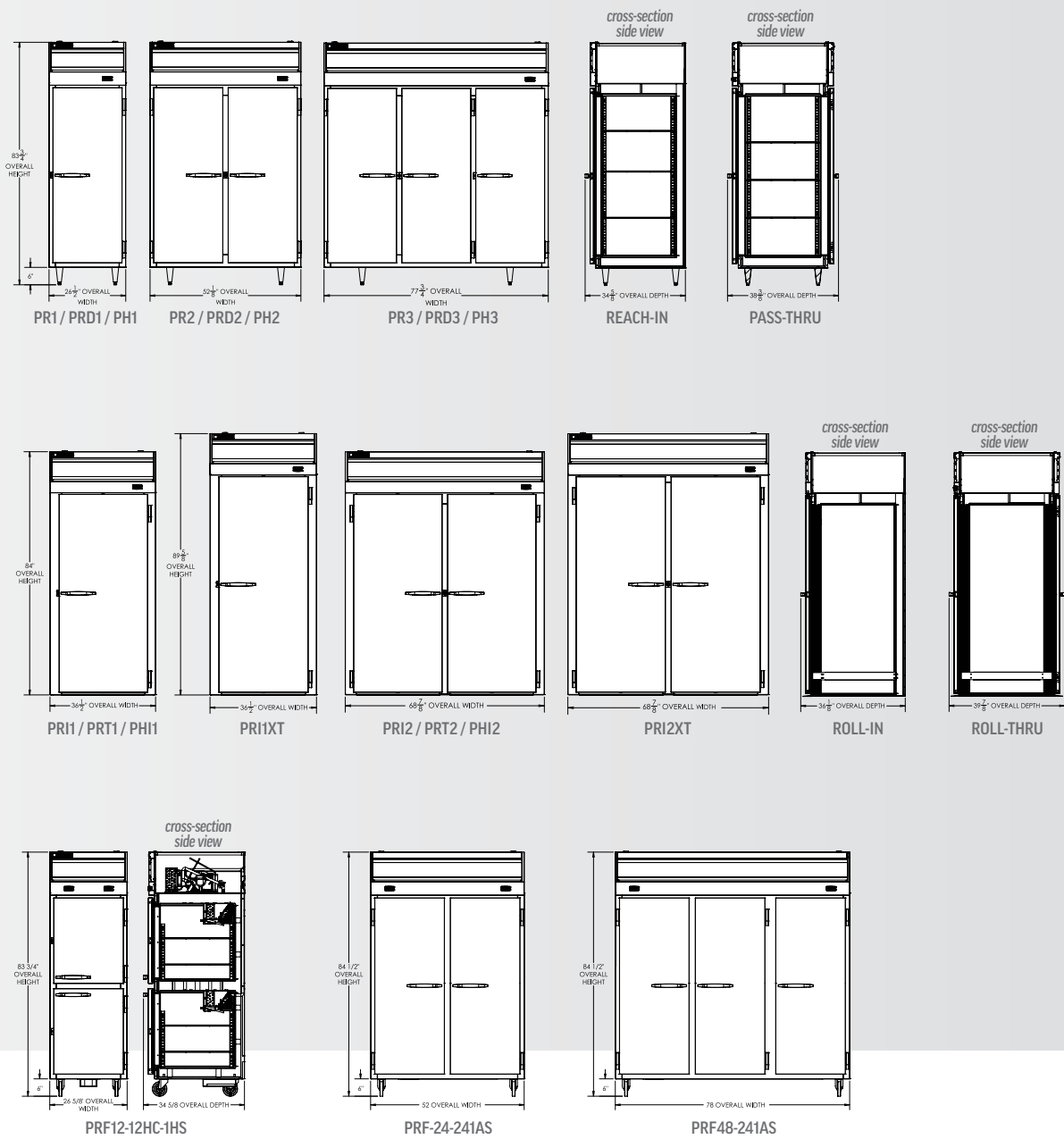







# GLASS DOOR MERCHANDISERS

CONSISTENT COOLING POWER WITH WELL LIT PRODUCT DISPLAY

# MARKETEER®

**Double pane, lowE argon-filled glass doors**

**LED lighting**

creates dynamic product presentation

**Electronic temperature control**

**Energy efficient and environmentally friendly**

R290 & R600 refrigerant

**DOE 2017 compliant  
& Energy Star 4.0 rated**

**Field-reversible doors**  
(hinge kit required)

**Self-closing hinged doors**  
with mechanical locks, standard

**1 & 2 door models available in  
Black or White finish options**

**Sliding glass doors available**  
on select units



**3 YEAR PARTS & LABOR WARRANTY WITH  
AN ADDITIONAL 2 YEAR COMPRESSOR WARRANTY**

**ENERGY STAR 4.0 RATED**

**UNIQUE SIZING OPTIONS**



**MECHANICAL LOCKS**  
standard on all hinged units



**BUILT-IN LED LIGHTS**  
for dynamic product presentation

**AVAILABLE DOORS**

- Hinged
- Sliding door

**AGENCY CERTIFICATIONS**



# Refrigerators

## REFRIGERATORS

| MODEL WIDTH           | DOOR TYPE | MODEL #    | DOORS/<br>SHELVES | VOLTS | HP  | AMPS | CUBIC<br>FEET | WIDTH | DEPTH | HEIGHT | CRATED<br>WEIGHT | COLOR |
|-----------------------|-----------|------------|-------------------|-------|-----|------|---------------|-------|-------|--------|------------------|-------|
| <b>19"</b><br>1 DOOR  | HINGED    | MT08-1H6B  | 1/5               | 115   | 1/8 | 1.8  | 5.98          | 18.88 | 20.63 | 71.38  | 189              | BLACK |
|                       |           | MT08-1H6W  |                   |       |     |      |               |       |       |        |                  | WHITE |
| <b>25"</b><br>1 DOOR  | HINGED    | MT10-1B    | 1/3               | 115   | 1/6 | 3.2  | 7.28          | 24.88 | 22.5  | 54.38  | 171              | BLACK |
|                       |           | MT10-1W    |                   |       |     |      |               |       |       |        |                  | WHITE |
|                       | HINGED    | MT12-1B    | 1/4               | 115   | 1/6 | 4.1  | 8.77          | 24.88 | 22.81 | 63.63  | 210.32           | BLACK |
|                       |           | MT12-1W    |                   |       |     |      |               |       |       |        |                  | WHITE |
| <b>30"</b><br>1 DOOR  | HINGED    | MT23-1B    | 1/5               | 115   | 1/3 | 7    | 14.97         | 29.56 | 26.13 | 78.63  | 246.91           | BLACK |
|                       |           | MT23-1W    |                   |       |     |      |               |       |       |        |                  | WHITE |
| <b>47"</b><br>2 DOORS | HINGED    | MT49-1B    | 2/10              | 115   | 1/2 | 8.3  | 30.55         | 47.13 | 30.13 | 79     | 441.8            | BLACK |
|                       |           | MT49-1W    |                   |       |     |      |               |       |       |        |                  | WHITE |
|                       | SLIDING   | MT49-1-SDB | 2/10              | 115   | 1/2 | 8.3  | 29.41         | 47.13 | 30.13 | 78.63  | 441.8            | BLACK |
|                       |           | MT49-1-SDW |                   |       |     |      |               |       |       |        |                  | WHITE |
| <b>54"</b><br>2 DOORS | HINGED    | MT53-1B    | 2/10              | 115   | 1/2 | 8.3  | 31.41         | 54.25 | 29.38 | 79     | 483.91           | BLACK |
|                       |           | MT53-1W    |                   |       |     |      |               |       |       |        |                  | WHITE |
|                       | SLIDING   | MT53-1-SDB | 2/10              | 115   | 1/2 | 8.7  | 34.98         | 54.25 | 29.38 | 78.63  | 483.91           | BLACK |
|                       |           | MT53-1-SDW |                   |       |     |      |               |       |       |        |                  | WHITE |

Depth measurement includes handles.

### EXTERIOR FINISHES

- Black
- White

### INTERIOR FINISHES

- White

### AVAILABLE ACCESSORIES

- Extra shelves & clips
- 3" Casters
- Visislide shelving kit



# MARKETMAX<sup>®</sup>

**Triple pane, lowE argon-filled glass doors**

**Field reversible (refrigerator only)**

**Self-closing doors**

120° stay open feature

**LED lighting**

creates dynamic product presentation

**Brightly lit sign panel**

**Custom door decals and signage available**

**Full electronic temperature control**

**Energy efficient and environmentally friendly R290 refrigerant**

**5 epoxy coated wire shelves per section**

**1, 2 & 3 door model options available**

**Sliding glass doors available on select units**



**ENERGY EFFICIENT R290/R600A PROVIDES SOLUTION FOR ALL ENVIRONMENTAL CONCERNS**

**DESIGNED TO PERFORM IN HIGH AMBIENT CONDITIONS**

**MADE IN THE USA**



**FULL ELECTRONIC CONTROL**  
with easy to read digital display



**BRIGHTLY LIT HEADER PANEL**  
to grab attention and increase sales

**AVAILABLE DOORS**

- Hinged
- Sliding door

**AGENCY CERTIFICATIONS**



# Refrigerators & Freezers



## EXTERIOR FINISHES

- Black
- White
- Stainless steel

## INTERIOR FINISHES

- Black
- White
- Stainless steel

## AVAILABLE ACCESSORIES

- Electronic locks
- Dual-temp models
- Wine models
- Door locks
- Gravity-Flo kits
- Price-tag molding
- Custom graphics

## AVAILABLE OPTIONS

- Left hand hinge doors
- Remote models available
- Header signs

## MOUNTING OPTIONS

- 6" casters
- 6" legs
- 3" casters

# MARKETMAX®

## REFRIGERATORS

MAINTAINS PRODUCT TEMPERATURES OF 36-38°F.

| MODEL WIDTH             | DOOR TYPE | MODEL #     | DOORS/<br>SHELVES | VOLTS | HP  | AMPS | CUBIC<br>FEET | WIDTH   | DEPTH | HEIGHT | CRATED<br>WEIGHT | COLOR |
|-------------------------|-----------|-------------|-------------------|-------|-----|------|---------------|---------|-------|--------|------------------|-------|
| <b>27"</b><br>1 DOOR    | HINGED    | MMR23HC-1-B | 1/5               | 115   | 1/4 | 3    | 23.1          | 27      | 33.63 | 78     | 358              | BLACK |
|                         |           | MMR23HC-1-W |                   |       |     |      |               |         |       |        |                  | WHITE |
| <b>30"</b><br>1 DOOR    | HINGED    | MMR27HC-1-B | 1/5               | 115   | 1/4 | 3    | 25.88         | 30      | 33.63 | 78     | 382              | BLACK |
|                         |           | MMR27HC-1-W |                   |       |     |      |               |         |       |        |                  | WHITE |
| <b>43.5"</b><br>2 DOORS | SLIDING   | MMR38HC-1-B | 2/10              | 115   | 1/3 | 5    | 35.37         | 43 1/2" | 32.25 | 78     | 478              | BLACK |
|                         |           | MMR38HC-1-W |                   |       |     |      |               |         |       |        |                  | WHITE |
| <b>47"</b><br>2 DOORS   | HINGED    | MMR44HC-1-B | 2/10              | 115   | 1/3 | 5    | 40.2          | 47      | 33.63 | 78     | 544              | BLACK |
|                         |           | MMR44HC-1-W |                   |       |     |      |               |         |       |        |                  | WHITE |
| <b>52"</b><br>2 DOORS   | SLIDING   | MMR45HC-1-B | 2/10              | 115   | 1/3 | 5    | 44            | 52      | 32.25 | 78     | 555              | BLACK |
|                         |           | MMR45HC-1-W |                   |       |     |      |               |         |       |        |                  | WHITE |
|                         | HINGED    | MMR49HC-1-B | 2/10              | 115   | 1/3 | 5    | 46.15         | 52      | 33.63 | 78     | 584              | BLACK |
|                         |           | MMR49HC-1-W |                   |       |     |      |               |         |       |        |                  | WHITE |
| <b>75"</b><br>3 DOORS   | SLIDING   | MMR66HC-1-B | 3/15              | 115   | 1/2 | 6.2  | 68.93         | 75      | 32.25 | 78     | 726              | BLACK |
|                         |           | MMR66HC-1-W |                   |       |     |      |               |         |       |        |                  | WHITE |
|                         | HINGED    | MMR72HC-1-B | 3/15              | 115   | 1/2 | 6.2  | 68.93         | 75      | 33.63 | 78     | 750              | BLACK |
|                         |           | MMR72HC-1-W |                   |       |     |      |               |         |       |        |                  | WHITE |

Depth measurement includes handles.

## FREEZERS

UTILIZES EXPANSION VALVE TECHNOLOGY TO  
MAINTAIN TEMPERATURE OF 0° TO -10°F.

| MODEL WIDTH           | DOOR TYPE | MODEL #       | DOORS/<br>SHELVES | VOLTS        | HP      | AMPS | CUBIC<br>FEET | WIDTH | DEPTH | HEIGHT | CRATED<br>WEIGHT | COLOR |
|-----------------------|-----------|---------------|-------------------|--------------|---------|------|---------------|-------|-------|--------|------------------|-------|
| <b>27"</b><br>1 DOOR  | HINGED    | MMF23HC-1-B   | 1/4               | 115          | 3/4     | 7.5  | 22.5          | 27    | 33.63 | 78     | 416              | BLACK |
|                       |           | MMF23HC-1-W   |                   |              |         |      |               |       |       |        |                  | WHITE |
| <b>30"</b><br>1 DOOR  | HINGED    | MMF27HC-1-B   | 1/4               | 115          | 3/4     | 7.5  | 26.57         | 30    | 33.63 | 78     | 427              | BLACK |
|                       |           | MMF27HC-1-W   |                   |              |         |      |               |       |       |        |                  | WHITE |
| <b>47"</b><br>2 DOORS | HINGED    | MMF44HC-1-B   | 2/10              | 115          | 3/4     | 13.8 | 45            | 47    | 33.63 | 78     | 568              | BLACK |
|                       |           | MMF44HC-1-W   |                   |              |         |      |               |       |       |        |                  | WHITE |
| <b>52"</b><br>2 DOORS | HINGED    | MMF49HC-1-B   | 2/10              | 115          | 3/4     | 11   | 46.2          | 52    | 33.63 | 78     | 596              | BLACK |
|                       |           | MMF49HC-1-W   |                   |              |         |      |               |       |       |        |                  | WHITE |
| <b>75"</b><br>3 DOORS | HINGED    | MMF72-5-B-LED | 3/15              | 115/208-230* | (2) 1/2 | 16   | 72            | 75    | 33.63 | 78     | 971              | BLACK |
|                       |           | MMF72-5-W-LED |                   |              |         |      |               |       |       |        |                  | WHITE |

\*Freezers powered by 115/208-230 volts are designed for field wiring (requires 4-wire electrical circuit, hard-wired).

Depth measurement includes handles.

## DUAL-TEMPS

MAINTAINS PRODUCT TEMPERATURES OF  
36-38°F (REFRIGERATOR), AND -10°F (FREEZER).

| MODEL WIDTH           | DOOR TYPE | MODEL #           | DOORS/<br>SHELVES | VOLTS        | HP               | AMPS              | CUBIC<br>FEET        | WIDTH | DEPTH | HEIGHT | CRATED<br>WEIGHT | COLOR |
|-----------------------|-----------|-------------------|-------------------|--------------|------------------|-------------------|----------------------|-------|-------|--------|------------------|-------|
| <b>52"</b><br>2 DOORS | HINGED    | MMRF49-1-BW-A-LED | 2/10              | 115          | R: 3/4<br>F: 1/2 | R: 10.9<br>F: 5.8 | R: 18.56<br>F: 18.56 | 52    | 33.63 | 78     | 696              | BLACK |
|                       |           | MMRF49-1-WW-A-LED |                   |              |                  |                   |                      |       |       |        |                  | WHITE |
| <b>75"</b><br>3 DOORS | HINGED    | MMRF72-1-BW-A-LED | 3/15              | 115/208-230* | R: 3/4<br>F: 1/2 | R: 10.9<br>F: 8.8 | R: 17.75<br>F: 37.92 | 75    | 33.63 | 78     | 942              | BLACK |
|                       |           | MMRF72-1-WW-A-LED |                   |              |                  |                   |                      |       |       |        |                  | WHITE |

\*Freezers powered by 115/208-230 volts are designed for field wiring (requires 4-wire electrical circuit, hard-wired).

Depth measurement includes handles.

### All options for MarketMax Dual Temps are specified within the model number using the designated codes described below.

#### MMRF49 EXAMPLE

Customer orders a MMRF49-1-BW-A

- Exterior will be black. Interior of the freezer AND the refrigerator will be white. (BW)
- The freezer will be on the left with left hand hinged door. The refrigerator will be on the right with right hand hinged door. (A)

#### MMRF72 EXAMPLE

Customer orders a MMRF72-1-WW-A

- Exterior will be white. Interior of the freezer AND the refrigerators will also be white. (WW)
- The freezer will be on the left with left hand hinged door. The 2 door refrigerator will be on the right with right hand hinged doors. (A)

#### MMRF49 - COOLER CONFIGURATIONS

##### SINGLE DOOR ON LEFT - SINGLE DOOR ON RIGHT

|          |  |
|----------|--|
| <b>A</b> | Freezer on the Left with Left Hand Hinged Door, Refrigerator on the Right with Right Hand Hinged Door  |
| <b>B</b> | Refrigerator on the Left with Left Hand Hinged Door, Freezer on the Right with Right Hand Hinged Door  |
| <b>C</b> | Freezer on the Left with Left Hand Hinged Door, Refrigerator on the Right with Left Hand Hinged Door   |
| <b>D</b> | Refrigerator on the Left with Left Hand Hinged Door, Freezer on the Right with Left Hand Hinged Door   |
| <b>E</b> | Freezer on the Left with Right Hand Hinged Door, Refrigerator on the Right with Right Hand Hinged Door |
| <b>F</b> | Refrigerator on the Left with Right Hand Hinged Door, Freezer on the Right with Right Hand Hinged Door |

#### MMRF72 - COOLER CONFIGURATIONS

##### SINGLE DOOR ON LEFT - TWO DOORS ON RIGHT

|          |  |
|----------|--|
| <b>A</b> | Freezer on the Left with Left Hand Hinged Door, 2 Door Refrigerator on the Right with Right Hand Hinged Doors      |
| <b>B</b> | Refrigerator on the Left with Left Hand Hinged Door, 2 Door Freezer on the Right with Right Hand Hinged Doors      |
| <b>C</b> | Freezer on the Left with Left Hand Hinged Door, 2 Door Refrigerator on the Right with Left Hand Hinged Doors       |
| <b>D</b> | Refrigerator on the Left with Left Hand Hinged Door, 2 Door Freezer on the Right with Left Hand Hinged Doors       |
| <b>E</b> | Freezer on the Left with Right Hand Hinged Door, 2 Door Refrigerator on the Right with Right Hand Hinged Doors     |
| <b>F</b> | Refrigerator on the Left with Right Hand Hinged Door, 2 Door Freezer on the Right with Right Hand Hinged Doors     |
| <b>G</b> | Freezer on the Left with Left Hand Hinged Door, 2 Door Refrigerator on the Right with Left/Right Hand Hinged Doors |
| <b>H</b> | Refrigerator on the Left with Left Hand Hinged Door, 2 Door Freezer on the Right with Left/Right Hand Hinged Doors |

#### COLOR COMBINATIONS

(BOTH CABINET INTERIORS BEING THE SAME COLOR)

|           |   |
|-----------|---|
| <b>BW</b> | Black Exterior / White Interior         |
| <b>WW</b> | White Exterior / White Interior         |
| <b>SW</b> | Stainless Exterior / White Interior     |
| <b>BB</b> | Black Exterior / Black Interior         |
| <b>BS</b> | Black Exterior / Stainless Interior     |
| <b>WB</b> | White Exterior / Black Interior         |
| <b>WS</b> | White Exterior / Stainless Interior     |
| <b>SS</b> | Stainless Exterior / Stainless Interior |
| <b>SB</b> | Stainless Exterior / Black Interior     |

##### TWO DOORS ON LEFT - SINGLE DOOR ON RIGHT

|          |   |
|----------|---|
| <b>J</b> | 2 Door Refrigerator on the Left with Left/Right Hand Hinged Doors, Single Door Freezer on the Right with Right Hand Hinged Door |
| <b>K</b> | 2 Door Freezer on the Left with Left/Right Hand Hinged Doors, Single Door Refrigerator on the Right with Right Hand Hinged Door |
| <b>L</b> | 2 Door Freezer on the Left with Left Hand Hinged Doors, Single Door Refrigerator on the Right with Left Hand Hinged Door        |
| <b>M</b> | 2 Door Refrigerator on the Left with Left Hand Hinged Doors, Single Door Freezer on the Right with Left Hand Hinged Door        |
| <b>N</b> | 2 Door Freezer on the Left with Right Hand Hinged Doors, Single Door Refrigerator on the Right with Right Hand Hinged Door      |
| <b>P</b> | 2 Door Refrigerator on the Left with Right Hand Hinged Doors, Single Door Freezer on the Right with Right Hand Hinged Door      |
| <b>Q</b> | 2 Door Refrigerator on the Left with Left Hand Hinged Doors, Single Door Freezer on the Right with Right Hand Hinged Door       |
| <b>R</b> | 2 Door Freezer on the Left with Left Hand Hinged Doors, Single Door Refrigerator on the Right with Right Hand Hinged Door       |

# COUNTERTOPS



## CT96

**Double pane, tempered glass door with locks**

**Heavy-duty black textured steel exterior**  
with black plastic door frames

**Heavy-duty white epoxy coated steel interior**

**LED lighting**  
creates dynamic product presentation

**3 epoxy coated shelves**  
top 2 shelves are adjustable

**Full electronic temperature control with display**

**Refrigeration system uses R600a refrigerant**  
to comply with all environmental concerns

**System is serviceable from the rear**

**Custom graphics available**

**1 year parts & labor warranty with an additional 4 year compressor warranty**

### REFRIGERATORS

MAINTAINS PRODUCT TEMPERATURES OF 35-41°F.

AGENCY CERTIFICATIONS



| MODEL       | MODEL #       | DOORS/SHELVES | VOLTS | HP  | AMPS | CUBIC FEET | WIDTH | DEPTH | HEIGHT | CRATED WEIGHT | EXTERIOR COLOR | INTERIOR COLOR |
|-------------|---------------|---------------|-------|-----|------|------------|-------|-------|--------|---------------|----------------|----------------|
| <b>CT96</b> | CT96HC-1-B    | 1/3           | 115   | 1/5 | 1.3  | 5.9        | 21.38 | 25.5  | 37.5   | 112           | BLACK          | WHITE          |
|             | CT96HC-1-S-MR |               |       |     |      |            |       |       |        |               | STAINLESS      | MIRROR         |

*Depth measurement includes handles.  
Height measurement includes mounting height.*

**ENERGY EFFICIENT R290/R600A PROVIDES SOLUTION FOR ALL ENVIRONMENTAL CONCERNS**

**DESIGNED TO PERFORM IN HIGH AMBIENT CONDITIONS**

**MADE IN THE USA**



**LED LIGHTING**  
for dynamic product presentation  
(CT96 & CF3 only)



**CUSTOM GRAPHICS AVAILABLE**  
for brand or product promotion  
(CT96 & CF3 only)



# Refrigerators & Freezers



## CF3

**Triple pane, tempered glass door**

**Pre-painted, steel interior and exterior**  
for easy cleaning

**LED lighting**  
creates dynamic product presentation

**2 shelves standard**  
one full & one half shelf

**Custom graphics available**

### AGENCY CERTIFICATIONS



**2" leveling legs**  
with up to 1" for leveling of the unit

**Refrigeration system uses R290 refrigerant**  
to comply with all environmental concerns

**3 year parts & labor warranty with an additional 2 year compressor warranty**



## UCF20

**Glass door provides clear merchandising of ice cream**

**Oversized refrigeration system holds -15°F to -10°F product temperature**

**Full electronic control**  
for enhanced defrost

### AGENCY CERTIFICATIONS



**Forced air design does not require unit to undergo manual defrost**  
which is a major advantage to comparable cold wall freezers

**20" footprint for countertop or undercounter applications**

## FREEZERS

| MODEL        | MODEL #              | DOORS/SHELVES | VOLTS | HP  | AMPS | CUBIC FEET | WIDTH | DEPTH | HEIGHT | CRATED WEIGHT | COLOR     | OPERATING TEMPERATURE |
|--------------|----------------------|---------------|-------|-----|------|------------|-------|-------|--------|---------------|-----------|-----------------------|
| <b>CF3</b>   | <b>CF3HC-1-W</b>     | 1/2           | 115   | 1/4 | 4    | 4          | 23.75 | 22.5  | 28.5   | 120           | WHITE     | -10° F                |
| <b>UCF20</b> | <b>UCF20HC-25-15</b> | 1/2           | 115   | 1/4 | 2.5  | 2.34       | 20    | 24.5  | 31.13  | 117           | STAINLESS | -10 to -15° F         |

*Depth measurement includes handles.*

# DIPPING CABINETS

**Galvanized metal cabinet**

with powder coated painted surface

**Easy-to-clean interior**

**Full electronic control**

**Sliding glass lids are LowE tempered**

**Lock and keys standard**

**2" Heavy-duty casters**

allow easy and fast movement

**Drain plug for easy cleaning**

**Lexan sneeze guard**

**Heavy-duty PVC coated wire support racks**

allows containers to be positioned on top level for optimal storage

**Each rack designed to hold**

multiple 3-gallon ice cream containers

**R290 refrigerant provides low energy consumption**

and is environmentally friendly



**3 YEAR PARTS & LABOR WARRANTY WITH AN ADDITIONAL 2 YEAR COMPRESSOR WARRANTY**

**R290 REFRIGERANT PROVIDES LOW ENERGY CONSUMPTION AND IS ENVIRONMENTALLY FRIENDLY**



**LID LOCKS STANDARD**  
for loss prevention



**LED LIGHTING**  
for dynamic product presentation

**ACCESS OPTIONS**

- Glass lids

**AGENCY CERTIFICATIONS**



## DIPPING CABINETS

COLD WALL SYSTEM MAINTAINS TEMPERATURES OF -10 to 8°F.

| MODEL WIDTH | MODEL #          | VOLTS | HP  | AMPS | CUBIC FEET | WIDTH | DEPTH | HEIGHT | CRATED WEIGHT | COLOR |
|-------------|------------------|-------|-----|------|------------|-------|-------|--------|---------------|-------|
| <b>50"</b>  | <b>BDC-HC-8</b>  | 120   | 1/3 | 5.4  | 15.2       | 50.4  | 26.4  | 52     | 225           | White |
| <b>68"</b>  | <b>BDC-HC-12</b> | 120   | 1/3 | 5.2  | 20.9       | 68.2  | 26.4  | 52     | 280           | White |

*Depth measurement includes handles.  
For total height, add 2 inches for the caster height.*

### BDC-HC-8 Capacity

Top rack: eight 3-gallon ice cream containers  
Bottom rack: six 3-gallon ice cream containers

### BDC-HC-12 Capacity

Top rack: twelve 3-gallon ice cream containers  
Bottom rack: ten 3-gallon ice cream containers

### EXTERIOR FINISHES

- White

### INTERIOR FINISHES

- White

### AVAILABLE ACCESSORIES

- Custom graphics
- 2 Ring tub



# NOVELTY CASES

**White coated steel exterior**

**White powder coated surface interior**

**R290 refrigerant provides low energy consumption**  
and is environmentally friendly

**LED lighting**

**Adjustable thermostat**

**Operating temperature of -10°F**

**Angle top design with LowE tempered glass lids**

**Lids are easily removable**

**Lid lock & keys**

**Round exterior edges**

**Integrated tag molding**

**2" heavy duty casters**

**Drain plug for easy cleaning**

**5 Removable baskets**



**3 YEAR PARTS & LABOR WARRANTY WITH  
AN ADDITIONAL 2 YEAR COMPRESSOR WARRANTY**

**R290 REFRIGERANT PROVIDES LOW ENERGY CONSUMPTION  
AND IS ENVIRONMENTALLY FRIENDLY**



**LID LOCKS STANDARD**  
for loss prevention



**LED LIGHTING**  
for dynamic product presentation

#### ACCESS OPTIONS

- Glass lids

#### AGENCY CERTIFICATIONS



## NOVELTY CASES

MAINTAINS TEMPERATURES OF -10°F.

| MODEL WIDTH | MODEL #    | LIDS/<br>BASKETS | VOLTS | HP  | AMPS | CUBIC<br>FEET | WIDTH | DEPTH | HEIGHT | CRATED<br>WEIGHT | COLOR |
|-------------|------------|------------------|-------|-----|------|---------------|-------|-------|--------|------------------|-------|
| 28"         | NC28HC-1-W | 2/2              | 115   | 1/5 | 3    | 6.02          | 28.1  | 26.4  | 32.2   | 144              | White |
| 34"         | NC34HC-1-W | 2/3              | 115   | 1/4 | 3    | 7.88          | 34.1  | 26.4  | 32.2   | 155              | White |
| 43"         | NC43HC-1-W | 2/4              | 115   | 1/4 | 3.5  | 10.3          | 42.7  | 26.4  | 32.2   | 180              | White |
| 51"         | NC51HC-1-W | 2/5              | 115   | 1/4 | 3.5  | 13.19         | 50.6  | 26.4  | 32.2   | 200              | White |

*Depth measurement includes handles.  
For total height, add 2 inches for the caster height.*



### EXTERIOR FINISHES

- White

### INTERIOR FINISHES

- White

### AVAILABLE ACCESSORIES

- Custom graphics
- Dip well

# Glass Door Merchandiser Accessories

| DESCRIPTION                                | UNIT(S)                      | PART NUMBER   |
|--|------------------------------|---------------|
| <b>SHELVING / ORGANIZERS</b>               |                              |               |
| Epoxy Coated Wire Shelf                    | MMR/MMF23                    | 403-900D-01   |
| Epoxy Coated Wire Shelf                    | MMR/MMF27                    | 403-871D-01   |
| Epoxy Coated Wire Shelf                    | MMR/MMF49                    | 403-873D-01   |
| Epoxy Coated Wire Shelf                    | MMR/MMF72                    | 403-874D-01   |
| Epoxy Coated Wire Shelf, Black             | MMR/MMF23                    | 403-900D-03   |
| Epoxy Coated Wire Shelf, Black             | MMR/MMF27                    | 403-871D-03   |
| Epoxy Coated Wire Shelf, Black             | MMR/MMF49                    | 403-873D-03   |
| Epoxy Coated Wire Shelf, Black             | MMR/MMF72                    | 403-874D-03   |
| Epoxy Coated Wire Shelf                    | MM14                         | 403-500D      |
| Wire Shelf                                 | CT96/CTF96 (New Model)       | CT9652        |
| CURVED Wine Rack (White)                   | MMR23                        | 403-905D-01   |
| CURVED Wine Rack (Black)                   | MMR23                        | 403-905D-02   |
| CURVED Wine Rack (White)                   | MMR27                        | 403-906D-01   |
| CURVED Wine Rack (Black)                   | MMR27                        | 403-906D-02   |
| CURVED Wine Rack (White)                   | MMR49                        | 403-907D-01   |
| CURVED Wine Rack (Black)                   | MMR49                        | 403-907D-02   |
| CURVED Wine Rack (White)                   | MMR72                        | 403-908D-01   |
| CURVED Wine Rack (Black)                   | MMR72                        | 403-908D-02   |
| FLAT Wine Rack with bottle support (White) | MMR23                        | 403-933D-01   |
| FLAT Wine Rack with bottle support (Black) | MMR23                        | 403-933D-02   |
| FLAT Wine Rack with bottle support (White) | MMR27                        | 403-934D-01   |
| FLAT Wine Rack with bottle support (Black) | MMR27                        | 403-934D-02   |
| FLAT Wine Rack with bottle support (White) | MMR49/45                     | 403-936D-01   |
| FLAT Wine Rack with bottle support (Black) | MMR49/45                     | 403-936D-02   |
| FLAT Wine Rack with bottle support (White) | MMR72/66                     | 403-937D-01   |
| FLAT Wine Rack with bottle support (Black) | MMR72/66                     | 403-937D-02   |
| FLAT Chrome Wine Rack with bottle support  | MMR23                        | 403-928D-03   |
| FLAT Chrome Wine Rack with bottle support  | MMR27                        | 403-929D-03   |
| FLAT Chrome Wine Rack with bottle support  | MMR49                        | 403-930D-03   |
| FLAT Chrome Wine Rack with bottle support  | MMR72                        | 403-931D-03   |
| Shelf Clip                                 | MMR/MMF Series               | 403-169A      |
| Novelty Basket (White)                     | MMF23                        | 403-938D-01   |
| Novelty Basket (Black)                     | MMF23                        | 403-938D-02   |
| Novelty Basket (White)                     | MMF27                        | 403-939D-01   |
| Novelty Basket (Black)                     | MMF27                        | 403-939D-02   |
| Novelty Basket (White)                     | MMF49                        | 403-940D-01   |
| Novelty Basket (Black)                     | MMF49                        | 403-940D-02   |
| Novelty Basket (White)                     | MMF72                        | 403-941D-01   |
| Novelty Basket (Black)                     | MMF72                        | 403-941D-02   |
| Shelf Clip                                 | CT96                         | CT9651        |
| Shelf Clip                                 | CTR3                         | 80FA39        |
| Gravity Flo Kits                           | MM14 (ONE KIT PER UNIT)      | 61C31-187A-01 |
| Gravity Flo Kits                           | MM23                         | 61C31-253D-01 |
| Gravity Flo Kits                           | MM27                         | 61C31-193A-01 |
| Gravity Flo Kits                           | MM49/72                      | 61C31-199A-01 |
| <b>MOUNTING</b>                            |                              |               |
| 3" Caster                                  | MM14                         | 61C01-008A    |
| 6" Seismic/Flanged Legs                    | MMR/MMF Series (set of four) | 00C31-055A    |

| DESCRIPTION                   | UNIT(S)                | PART NUMBER   |
|-------------------------------|------------------------|---------------|
| <b>SIGNAGE</b>                |                        |               |
| Price Tag Molding (per shelf) | MMR/F 23, 45/49, 66/72 | 61A32-082D-01 |
| Price Tag Molding (per shelf) | MMR/F 27               | 61A32-090D-02 |
| Brushed sign 26-3/8" x 8.5"   | MMR23/MMF23            | 409-505B-01   |
| Brushed sign 29 1/8" x 8.5"   | MMR27/MMF27            | 409-505B-02   |
| Brushed sign 46.13" W x 8.5"  | MMR44/MMF44            | 409-505B-04   |
| Brushed sign 51 1/8" x 8.5"   | MMR/MMF49              | 409-505B-05   |
| Brushed sign 74 1/4" x 8.5"   | MMR/MMF72              | 409-505B-06   |
| Flat Black Sign               | MMR23/MMF23            | 409-488B-01   |
| Flat Black Sign               | MMR/MMF27              | 409-488B-02   |
| Flat Black Sign               | MMR/MMF49              | 409-488B-05   |
| Flat Black Sign               | MMR/MMF72              | 409-488B-06   |
| Flat White Sign               | MMR23/MMF23            | 409-418C-053  |
| Flat White Sign               | MMR/MMF27              | 409-419C-140  |
| Flat White Sign               | MMR/MMF49              | 409-422C-109  |
| Flat White Sign               | MMR/MMF72              | 409-423C-061  |
| Self-Serve Sign               | MMR23/MMF23            | 409-418C-054  |
| Self-Serve Sign               | MMR/MMF27              | 409-419C-141  |
| Self-Serve Sign               | MMR/MMF49/MMRF49       | 409-422C-110  |
| Self-Serve Sign               | MMR/MMF72/MMRF72       | 409-423C-062  |
| Fresh Foods Sign              | MMR23/MMF23            | 409-418C-056  |
| Fresh Foods Sign              | MMR/MMF27              | 409-419C-143  |
| Fresh Foods Sign              | MMR/MMF49              | 409-422C-112  |
| Fresh Foods Sign              | MMR/MMF72              | 409-423C-064  |
| Cold Drinks Sign              | MMR23                  | 409-418C-055  |
| Cold Drinks Sign              | MMR27                  | 409-419C-142  |
| Cold Drinks Sign              | MMR49                  | 409-422C-111  |
| Cold Drinks Sign              | MMR72                  | 409-423C-063  |
| Chilled Wine Sign - Brown     | MMR23                  | 409-418C-061  |
| Chilled Wine Sign - Brown     | MMR27                  | 409-419C-146  |
| Chilled Wine Sign - Brown     | MMR49                  | 409-422C-117  |
| Chilled Wine Sign - Brown     | MMR72                  | 409-423C-066  |
| Chilled Wine Sign - Sepia     | MMR23                  | 409-418C-062  |
| Chilled Wine Sign - Sepia     | MMR27                  | 409-419C-147  |
| Chilled Wine Sign - Sepia     | MMR49                  | 409-422C-118  |
| Chilled Wine Sign - Sepia     | MMR72                  | 409-423C-067  |
| Chilled Wine Sign - Curved    | MMR23                  | 409-418C-063  |
| Chilled Wine Sign - Curved    | MMR27                  | 409-419C-148  |
| Chilled Wine Sign - Curved    | MMR49                  | 409-422C-119  |
| Chilled Wine Sign - Curved    | MMR72                  | 409-423C-068  |
| Got Milk Sign                 | MMR27                  | 409-419C-102  |
| Got Milk Sign                 | MMR 45/49              | 409-422C-087  |
| Got Milk Sign                 | MMR 66/72              | 409-423C-054  |
| <b>ADDITIONAL ACCESSORIES</b> |                        |               |
| Door Lock                     | CT96                   | 61C11S043A    |
| Door Lock                     | CR5                    | 61C11-040A    |







# OPEN AIR MERCHANDISERS

EASY-ACCESS AND HIGH VISIBILITY PRODUCT DISPLAYS

# BREEZE™

**Exterior finish is a heavy-duty steel**  
with a durable, baked on black or white coating

**Curved design with open front & side shield**  
to maximize product display

**Interior is white coated steel**

**2 recessed interior lights**  
provide maximum product visibility

**3 epoxy coated shelves**

**Modern grille is easy to remove**  
for cleaning or service

**Gravity-Flo organizer**

**Holds unit temperature from 32°-40°F**

**Certified for bottled beverage  
& packaged foods**

**Brightly lit sign panel**



**3 YEAR PARTS & LABOR WARRANTY  
WITH AN ADDITIONAL 2 YEAR COMPRESSOR WARRANTY**

**UNIQUE SIZE SUITED FOR ENDCAPS AND SCHOOLS**

**CUSTOM GRAPHICS AVAILABLE**



**SIDE SHIELD**  
to maximize product display



**GRAVITY FLO**  
organizer standard

## AGENCY CERTIFICATIONS



## REFRIGERATORS

MAINTAINS PRODUCT TEMPERATURES OF 32-38°F.

| MODEL WIDTH | MODEL #  | SHELVES | VOLTS | HP  | AMPS | CUBIC FEET | WIDTH | DEPTH | HEIGHT | CRATED WEIGHT | COLOR |
|-------------|----------|---------|-------|-----|------|------------|-------|-------|--------|---------------|-------|
| 30"         | BZ13-1-B | 3       | 115   | 1/2 | 12   | 12.63      | 30    | 32.75 | 54.38  | 336           | BLACK |
|             | BZ13-1-W |         |       |     |      |            |       |       |        |               | WHITE |



### EXTERIOR FINISHES

- Black
- White

### INTERIOR FINISHES

- White

### AVAILABLE ACCESSORIES

- Black dividers
- Black shelves
- Roller kit
- Custom graphics and signage



# VUEMAX™

**Heavy duty steel exterior**  
with a durable paint finish

**Glass sides enhance product visibility**  
from side viewpoints

**Foamed in place CFC-free polyurethane**  
insulation enhances the structural strength of the cabinet and increases energy efficiency

**LED lighting**  
enhances product illumination  
for maximum product visibility

**Shelving display flexibility**  
Shelves can be installed in two positions

**Full electronic temperature control**  
from 36° -40°F, with display

**Certified for bottled beverage  
& packaged foods**

**Night curtain**

**Stylish impact bumper**



**SIDE SHIELD**  
to maximize product display



**CUSTOM GRAPHICS AVAILABLE**  
for brand or product promotion

## AGENCY CERTIFICATIONS





## REFRIGERATORS

MAINTAINS PRODUCT TEMPERATURES OF 36-38°F.

| MODEL WIDTH | MODEL # | SHELVES | VOLTS | HP      | AMPS | CUBIC FEET | WIDTH | DEPTH | HEIGHT | CRATED WEIGHT |
|-------------|---------|---------|-------|---------|------|------------|-------|-------|--------|---------------|
| 35"         | VM7-1   | 3       | 120   | 1/3     | 7.5  | 9.58       | 34.8  | 31.7  | 59.3   | 433           |
|             | VM12-1  | 5       | 120   | (2) 1/4 | 10   | 15.45      | 34.8  | 31.7  | 78.8   | 524           |
| 51.5"       | VM18-1  | 5       | 120   | (2) 1/3 | 16   | 23.87      | 51.5  | 31.7  | 78.8   | 652           |



**3 YEAR PARTS & LABOR WARRANTY WITH AN ADDITIONAL 2 YEAR COMPRESSOR WARRANTY**

**IDEAL FOR GOURMET SHOPS, DELICATESSENS, CONVENIENCE STORES & BAKERIES**

### EXTERIOR FINISHES

- Black
- White
- Grey

### INTERIOR FINISHES

- White

### AVAILABLE ACCESSORIES

- Security Cover
- Bar/bag hooks
- Price tag molding
- Spring-loaded Product Dispensers
- Custom graphics available

### MOUNTING OPTIONS

- 6" adjustable legs (standard)
- 5" casters

# Open Air Merchandiser Accessories

| DESCRIPTION  | UNIT(S)                     | PART NUMBER                 |
|--|-----------------------------|-----------------------------|
| <b>SHELVING / ORGANIZERS</b>                         |                             |                             |
| Epoxy Coated Wire Shelf, Black Dividers              | BZ13                        | 403-749D-01                 |
| Shelf Clip   | BZ13                        | 403-168A                    |
| <b>MOUNTING</b>                                      |                             |                             |
| 2" Roller Kit  | BZ13                        | 61C01-010A                  |
| 5" Caster  | VM7/VM12/VM18 (set of four) | 61C01-014D-01               |
| <b>MERCHANDISING ACCESSORIES</b>                     |                             |                             |
| Front Product Display                                | VM-7/12                     | 183602102                   |
| Front Product Display                                | VM-18                       | 183602101                   |
| Side Saddle Bag Assembly                             | VM-18                       | 183110202                   |
| Side Saddle Bag Assembly                             | VM-7                        | 183110203                   |
| Clearcool Curtain Assembly, Plastic Strips           | VM-18                       | CLEARCOOL120                |
| Clearcool Curtain Assembly, Plastic Strips           | VM-12                       | CLEARCOOL77                 |
| Clearcool Curtain Assembly, Plastic Strips           | VM-7                        | CLEARCOOL55                 |
| Wonder Bar Assembly, 48" Saddle Style Black w/6 Pegs | VM-7/12                     | WonderBar-ALPA-55/77 BLACK  |
| Wonder Bar Assembly, 48" Saddle Style Black w/6 Pegs | VM-18                       | WonderBar-ALPA-99/120 BLACK |
| <b>ADDITIONAL ACCESSORIES</b>                        |                             |                             |
| Locking Cage w/Lock                                  | VM7                         | 103304002-ASM               |
| Locking Cage w/Lock                                  | VM12                        | 103304001-ASM               |
| Locking Cage w/Lock                                  | VM15                        | 103304003-ASM               |
| Locking Cage w/Lock                                  | VM18                        | 103304000-ASM               |
| Base Kit   | BZ13                        | 807-838C                    |









# FOOD PREP TABLES

BACK BONE OF FOOD SERVICE WITH ALMOST LIMITLESS OPTIONS

# SANDWICH PREP

**Full electronic control**

**Reversible cutting boards**

1/2" thick, 10" deep

**Locking divider bars**

**Heavy-duty aluminum pan liner**

easy to clean and prevents spills from falling into cabinet while also ensuring coldest air flows across bottom of pans

**Field reversible doors**

with 120 degree stay-open feature

**Two epoxy coated shelves**

per door section standard

**Snap-in door gaskets**

**Accommodates up to 6" deep food service pans**

4" deep 1/6 size polycarbonate pans are included (excludes -A models)

**Heavy duty insulated covers**

protects products and eliminates sweating when closed

**6" heavy duty casters standard**

3" casters or 6" leg option available at no charge when specified on order



**DESIGNED TO PERFORM IN HIGH AMBIENT CONDITIONS**

**3 YEAR PARTS & LABOR WARRANTY WITH AN ADDITIONAL 2 YEAR COMPRESSOR WARRANTY**

**MADE IN USA**



**PERFECT SEAL PAN LINER**  
ensures airflow under pans and protects bottom of cabinet from pan spills



**CLEAR LIDS AVAILABLE**  
for optimized product display

**ACCESS OPTIONS**

- Doors
- Drawers
- Dual-sided

**AGENCY CERTIFICATIONS**



# Food Prep Tables



## EXTERIOR FINISHES

- Stainless steel with galvanized back
- Stainless steel with stainless back

## INTERIOR FINISHES

- Galvanized
- Stainless steel

## AVAILABLE ACCESSORIES

- 12" crossbar
- Side/front crumb catchers
- Overshelf kits
- Composite cutting boards
- Bun tray rack
- Locks (for solid doors)

## AVAILABLE OPTIONS

- Left hand hinge doors
- Remote models available

## LID OPTIONS

- Clear lids
- Flat-hinged lids
- Lift-off lids
- See-thru lids

## MOUNTING OPTIONS

- 6" casters
- 3" casters (allows for ADA compliant working height)
- 6" legs

# SANDWICH PREP

## Standard Top

### DOORS

MAINTAINS PRODUCT TEMPERATURES OF 36-38°F.

| MODEL WIDTH           | MODEL #    | DOORS/<br>SHELVES | VOLTS | HP  | AMPS | CUBIC<br>FEET | WIDTH | DEPTH | HEIGHT | CRATED<br>WEIGHT | STANDARD PANS<br>4" DEEP   |
|-----------------------|------------|-------------------|-------|-----|------|---------------|-------|-------|--------|------------------|----------------------------|
| <b>27"</b><br>1 DOOR  | SPE27HC    | 1/2               | 115   | 1/6 | 2    | 6.91          | 27    | 32    | 39.38  | 202              | (6) 1/6 size, (2) 1/9 size |
|                       | SPE27HC-B  |                   |       |     |      |               |       |       |        |                  | (8) 1/6                    |
| <b>32"</b><br>1 DOOR  | SPE32HC-08 | 1/2               | 115   | 1/6 | 2    | 8.01          | 32    | 32    | 39.25  | 239              | (8) 1/6 size               |
| <b>36"</b><br>2 DOORS | SPE36HC-08 | 2/4               | 115   | 1/6 | 2    | 10.01         | 36    | 32    | 39     | 250              | (8) 1/6 size               |
|                       | SPE36HC-10 |                   |       |     |      |               |       |       |        | 252              | (10) 1/6 size              |
| <b>48"</b><br>2 DOORS | SPE48HC-08 | 2/4               | 115   | 1/6 | 2.2  | 13.01         | 48    | 32    | 39.25  | 296              | (8) 1/6 size               |
|                       | SPE48HC-10 |                   |       |     |      |               |       |       |        | 296              | (10) 1/6 size              |
|                       | SPE48HC-12 |                   |       |     |      |               |       |       |        | 302              | (12) 1/6 size              |
| <b>60"</b><br>2 DOORS | SPE60HC-08 | 2/4               | 115   | 1/3 | 5.4  | 16.02         | 60    | 32    | 39     | 346              | (8) 1/6 size               |
|                       | SPE60HC-10 |                   |       |     |      |               |       |       |        | 348              | (10) 1/6 size              |
|                       | SPE60HC-12 |                   |       |     |      |               |       |       |        | 342              | (12) 1/6 size              |
|                       | SPE60HC-16 |                   |       |     |      |               |       |       |        | 360              | (16) 1/6 size              |
| <b>72"</b><br>3 DOORS | SPE72HC-08 | 3/6               | 115   | 1/3 | 5.4  | 20.02         | 72    | 32    | 39     | 432              | (8) 1/6 size               |
|                       | SPE72HC-10 |                   |       |     |      |               |       |       |        | 432              | (10) 1/6 size              |
|                       | SPE72HC-12 |                   |       |     |      |               |       |       |        | 398              | (12) 1/6 size              |
|                       | SPE72HC-18 |                   |       |     |      |               |       |       |        | 388              | (18) 1/6 size              |

For total height, add 3 or 6 inches, based on your mounting choice. Depth measurement includes handles.

### CONDIMENT STATIONS WITH SNEEZEGUARD

MAINTAINS PRODUCT TEMPERATURES OF 36-38°F.

| MODEL WIDTH | MODEL #        | DOORS/<br>SHELVES | VOLTS | HP  | AMPS | CUBIC<br>FEET | WIDTH | DEPTH | HEIGHT | CRATED<br>WEIGHT | STANDARD PANS<br>4" DEEP |
|-------------|----------------|-------------------|-------|-----|------|---------------|-------|-------|--------|------------------|--------------------------|
| <b>27"</b>  | SPE27HC-SNZ    | 1/2               | 115   | 1/6 | 2    | 7.3           | 27    | 32    | 53     | 202              | (6) 1/6 pans, (2) 1/9    |
| <b>48"</b>  | SPE48HC-12-SNZ | 2/4               | 115   | 1/6 | 2.2  | 13.9          | 48    | 32    | 53.13  | 308              | (12) 1/6 pans            |

#### AVAILABLE OPTIONS

| SUFFIX   | OPTION                  |
|--|-------------------------|
| <b>24</b>                                      | Left hand hinge doors   |
| <b>R</b>                                       | Remote models available |
| Append suffix to model #<br>when placing order |                         |

## DRAWERS

MAINTAINS PRODUCT TEMPERATURES OF 36-38°F.

| MODEL WIDTH | MODEL #       | DRAWERS | DOORS/SHELVES | VOLTS | HP  | AMPS | CUBIC FEET | WIDTH | DEPTH | HEIGHT | CRATED WEIGHT | STANDARD PANS 4" DEEP       |
|-------------|---------------|---------|---------------|-------|-----|------|------------|-------|-------|--------|---------------|-----------------------------|
| <b>27"</b>  | SPED27HC      | 2       | –             | 115   | 1/6 | 2    | 6.91       | 27    | 32    | 39.38  | 232           | (6) 1/6 size & (2) 1/9 size |
|             | SPED27HC-B    | 2       | –             |       |     |      |            |       |       |        | 238           | (8) 1/6 size                |
| <b>32"</b>  | SPED32HC-08-2 | 2       | –             | 115   | 1/6 | 2    | 8.01       | 32    | 32    | 39.25  | 269           | (8) 1/6 size                |
| <b>36"</b>  | SPED36HC-08-2 | 2       | –             | 115   | 1/6 | 2    | 10.01      | 36    | 32    | 39     | 276           | (8) 1/6 size                |
|             | SPED36HC-10-2 | 2       | –             |       |     |      |            |       |       |        | 278           | (10) 1/6 size               |
| <b>48"</b>  | SPED48HC-08-2 | 2       | 1/2           | 115   | 1/6 | 2.2  | 13.01      | 48    | 32    | 39.25  | 358           | (8) 1/6 size                |
|             | SPED48HC-08-4 | 4       | –             |       |     |      |            |       |       |        | 358           | (8) 1/6 size                |
|             | SPED48HC-10-2 | 2       | 1/2           | 115   | 1/6 | 2.2  | 13.01      | 48    | 32    | 39.25  | 326           | (10) 1/6 size               |
|             | SPED48HC-10-4 | 4       | –             |       |     |      |            |       |       |        | 326           | (10) 1/6 size               |
|             | SPED48HC-12-2 | 2       | 1/2           | 115   | 1/6 | 2.2  | 13.01      | 48    | 32    | 39.25  | 332           | (12) 1/6 size               |
|             | SPED48HC-12-4 | 4       | –             |       |     |      |            |       |       |        | 356           | (12) 1/6 size               |
| <b>60"</b>  | SPED60HC-08-2 | 2       | 1/2           | 115   | 1/3 | 5.4  | 16.02      | 60    | 32    | 39     | 404           | (8) 1/6 size                |
|             | SPED60HC-08-4 | 4       | –             |       |     |      |            |       |       |        | 404           | (8) 1/6 size                |
|             | SPED60HC-10-2 | 2       | 1/2           | 115   | 1/3 | 5.4  | 16.02      | 60    | 32    | 39     | 356           | (10) 1/6 size               |
|             | SPED60HC-10-4 | 4       | –             |       |     |      |            |       |       |        | 406           | (10) 1/6 size               |
|             | SPED60HC-12-2 | 2       | 1/2           | 115   | 1/3 | 5.4  | 16.02      | 60    | 32    | 39     | 408           | (12) 1/6 size               |
|             | SPED60HC-12-4 | 4       | –             |       |     |      |            |       |       |        | 402           | (12) 1/6 size               |
|             | SPED60HC-16-2 | 2       | 1/2           | 115   | 1/3 | 5.4  | 16.02      | 60    | 32    | 39     | 382           | (16) 1/6 size               |
|             | SPED60HC-16-4 | 4       | –             |       |     |      |            |       |       |        | 414           | (16) 1/6 size               |
| <b>72"</b>  | SPED72HC-08-2 | 2       | 2/4           | 115   | 1/3 | 5.4  | 20.02      | 72    | 32    | 39.13  | 450           | (8) 1/6 size                |
|             | SPED72HC-08-4 | 4       | 1/2           |       |     |      |            |       |       |        | 450           | (8) 1/6 size                |
|             | SPED72HC-08-6 | 6       | –             |       |     |      |            |       |       |        | 456           | (8) 1/6 size                |
|             | SPED72HC-10-2 | 2       | 2/4           | 115   | 1/3 | 5.4  | 20.02      | 72    | 32    | 39.13  | 448           | (10) 1/6 size               |
|             | SPED72HC-10-4 | 4       | 1/2           |       |     |      |            |       |       |        | 450           | (10) 1/6 size               |
|             | SPED72HC-10-6 | 6       | –             |       |     |      |            |       |       |        | 452           | (10) 1/6 size               |
|             | SPED72HC-12-2 | 2       | 2/4           | 115   | 1/3 | 5.4  | 20.02      | 72    | 32    | 39.13  | 418           | (12) 1/6 size               |
|             | SPED72HC-12-4 | 4       | 1/2           |       |     |      |            |       |       |        | 442           | (12) 1/6 size               |
|             | SPED72HC-12-6 | 6       | –             |       |     |      |            |       |       |        | 484           | (12) 1/6 size               |
|             | SPED72HC-18-2 | 2       | 2/4           | 115   | 1/3 | 5.4  | 20.02      | 72    | 32    | 39.13  | 432           | (18) 1/6 size               |
|             | SPED72HC-18-4 | 4       | 1/2           |       |     |      |            |       |       |        | 460           | (18) 1/6 size               |
|             | SPED72HC-18-6 | 6       | –             |       |     |      |            |       |       |        | 484           | (18) 1/6 size               |

For total height, add 3 or 6 inches, based on your mounting choice. Depth measurement includes handles.

# SANDWICH PREP

## Clear Lid Standard Top

### DOORS

MAINTAINS PRODUCT TEMPERATURES OF 36-38°F.

| MODEL WIDTH           | MODEL #       | DOORS/SHELVES | VOLTS | HP  | AMPS | CUBIC FEET | WIDTH | DEPTH | HEIGHT | CRATED WEIGHT | STANDARD PANS 4" DEEP      |
|-----------------------|---------------|---------------|-------|-----|------|------------|-------|-------|--------|---------------|----------------------------|
| <b>27"</b><br>1 DOOR  | SPE27HC-CL    | 1/2           | 115   | 1/6 | 2    | 6.91       | 27    | 32    | 44.75  | 202           | (6) 1/6 size, (2) 1/9 size |
|                       | SPE27HC-B-CL  |               |       |     |      |            |       |       |        |               | (8) 1/6                    |
| <b>32"</b><br>1 DOOR  | SPE32HC-08-CL | 1/2           | 115   | 1/6 | 2    | 8.01       | 32    | 32    | 44.63  | 239           | (8) 1/6 size               |
| <b>36"</b><br>2 DOORS | SPE36HC-08-CL | 2/4           | 115   | 1/6 | 2    | 10.01      | 36    | 32    | 44.5   | 250           | (8) 1/6 size               |
|                       | SPE36HC-10-CL |               |       |     |      |            |       |       |        | 252           | (10) 1/6 size              |
| <b>48"</b><br>2 DOORS | SPE48HC-08-CL | 2/4           | 115   | 1/6 | 2.2  | 13.01      | 48    | 32    | 44.5   | 296           | (8) 1/6 size               |
|                       | SPE48HC-10-CL |               |       |     |      |            |       |       |        | 296           | (10) 1/6 size              |
|                       | SPE48HC-12-CL |               |       |     |      |            |       |       |        | 302           | (12) 1/6 size              |
| <b>60"</b><br>2 DOORS | SPE60HC-08-CL | 2/4           | 115   | 1/3 | 5.4  | 16.02      | 60    | 32    | 44.5   | 346           | (8) 1/6 size               |
|                       | SPE60HC-10-CL |               |       |     |      |            |       |       |        | 348           | (10) 1/6 size              |
|                       | SPE60HC-12-CL |               |       |     |      |            |       |       |        | 342           | (12) 1/6 size              |
|                       | SPE60HC-16-CL |               |       |     |      |            |       |       |        | 360           | (16) 1/6 size              |
| <b>72"</b><br>3 DOORS | SPE72HC-08-CL | 3/6           | 115   | 1/3 | 5.4  | 20.02      | 72    | 32    | 44.5   | 432           | (8) 1/6 size               |
|                       | SPE72HC-10-CL |               |       |     |      |            |       |       |        | 432           | (10) 1/6 size              |
|                       | SPE72HC-12-CL |               |       |     |      |            |       |       |        | 398           | (12) 1/6 size              |
|                       | SPE72HC-18-CL |               |       |     |      |            |       |       |        | 388           | (18) 1/6 size              |

NEW

| AVAILABLE OPTIONS                           |                         |
|---|-------------------------|
| SUFFIX                                      | OPTION                  |
| <b>24</b>                                   | Left hand hinge doors   |
| <b>R</b>                                    | Remote models available |
| Append suffix to model # when placing order |                         |

For total height, add 3 or 6 inches, based on your mounting choice. Depth measurement includes handles.

## CLEAR LIDS



## DRAWERS

MAINTAINS PRODUCT TEMPERATURES OF 36-38°F.

| MODEL WIDTH | MODEL #          | DRAWERS | DOORS/SHELVES | VOLTS | HP  | AMPS | CUBIC FEET | WIDTH | DEPTH | HEIGHT | CRATED WEIGHT | STANDARD PANS 4" DEEP       |
|-------------|------------------|---------|---------------|-------|-----|------|------------|-------|-------|--------|---------------|-----------------------------|
| <b>27"</b>  | SPED27HC-CL      | 2       | –             | 115   | 1/6 | 2    | 6.91       | 27    | 32    | 44.75  | 232           | (6) 1/6 size & (2) 1/9 size |
|             | SPED27HC-B-CL    | 2       | –             |       |     |      |            |       |       |        | 238           | (8) 1/6 size                |
| <b>32"</b>  | SPED32HC-08-2-CL | 2       | –             | 115   | 1/6 | 2    | 8.01       | 32    | 32    | 44.63  | 269           | (8) 1/6 size                |
| <b>36"</b>  | SPED36HC-08-2-CL | 2       | –             | 115   | 1/6 | 2    | 10.01      | 36    | 32    | 44.5   | 276           | (8) 1/6 size                |
|             | SPED36HC-10-2-CL | 2       | –             |       |     |      |            |       |       |        | 278           | (10) 1/6 size               |
| <b>48"</b>  | SPED48HC-08-2-CL | 2       | 1/2           | 115   | 1/6 | 2.2  | 13.01      | 48    | 32    | 44.5   | 358           | (8) 1/6 size                |
|             | SPED48HC-08-4-CL | 4       | –             |       |     |      |            |       |       |        | 358           | (8) 1/6 size                |
|             | SPED48HC-10-2-CL | 2       | 1/2           | 115   | 1/6 | 2.2  | 13.01      | 48    | 32    | 44.5   | 326           | (10) 1/6 size               |
|             | SPED48HC-10-4-CL | 4       | –             |       |     |      |            |       |       |        | 326           | (10) 1/6 size               |
|             | SPED48HC-12-2-CL | 2       | 1/2           | 115   | 1/6 | 2.2  | 13.01      | 48    | 32    | 44.5   | 332           | (12) 1/6 size               |
|             | SPED48HC-12-4-CL | 4       | –             |       |     |      |            |       |       |        | 356           | (12) 1/6 size               |
| <b>60"</b>  | SPED60HC-08-2-CL | 2       | 1/2           | 115   | 1/3 | 5.4  | 16.02      | 60    | 32    | 44.5   | 404           | (8) 1/6 size                |
|             | SPED60HC-08-4-CL | 4       | –             |       |     |      |            |       |       |        | 404           | (8) 1/6 size                |
|             | SPED60HC-10-2-CL | 2       | 1/2           | 115   | 1/3 | 5.4  | 16.02      | 60    | 32    | 44.5   | 356           | (10) 1/6 size               |
|             | SPED60HC-10-4-CL | 4       | –             |       |     |      |            |       |       |        | 406           | (10) 1/6 size               |
|             | SPED60HC-12-2-CL | 2       | 1/2           | 115   | 1/3 | 5.4  | 16.02      | 60    | 32    | 44.5   | 408           | (12) 1/6 size               |
|             | SPED60HC-12-4-CL | 4       | –             |       |     |      |            |       |       |        | 402           | (12) 1/6 size               |
|             | SPED60HC-16-2-CL | 2       | 1/2           | 115   | 1/3 | 5.4  | 16.02      | 60    | 32    | 44.5   | 382           | (16) 1/6 size               |
|             | SPED60HC-16-4-CL | 4       | –             |       |     |      |            |       |       |        | 414           | (16) 1/6 size               |
| <b>72"</b>  | SPED72HC-08-2-CL | 2       | 2/4           | 115   | 1/3 | 5.4  | 20.02      | 72    | 32    | 44.5   | 450           | (8) 1/6 size                |
|             | SPED72HC-08-4-CL | 4       | 1/2           |       |     |      |            |       |       |        | 450           | (8) 1/6 size                |
|             | SPED72HC-08-6-CL | 6       | –             |       |     |      |            |       |       |        | 456           | (8) 1/6 size                |
|             | SPED72HC-10-2-CL | 2       | 2/4           | 115   | 1/3 | 5.4  | 20.02      | 72    | 32    | 44.5   | 448           | (10) 1/6 size               |
|             | SPED72HC-10-4-CL | 4       | 1/2           |       |     |      |            |       |       |        | 450           | (10) 1/6 size               |
|             | SPED72HC-10-6-CL | 6       | –             |       |     |      |            |       |       |        | 452           | (10) 1/6 size               |
|             | SPED72HC-12-2-CL | 2       | 2/4           | 115   | 1/3 | 5.4  | 20.02      | 72    | 32    | 44.5   | 418           | (12) 1/6 size               |
|             | SPED72HC-12-4-CL | 4       | 1/2           |       |     |      |            |       |       |        | 442           | (12) 1/6 size               |
|             | SPED72HC-12-6-CL | 6       | –             |       |     |      |            |       |       |        | 484           | (12) 1/6 size               |
|             | SPED72HC-18-2-CL | 2       | 2/4           | 115   | 1/3 | 5.4  | 20.02      | 72    | 32    | 44.5   | 432           | (18) 1/6 size               |
|             | SPED72HC-18-4-CL | 4       | 1/2           |       |     |      |            |       |       |        | 460           | (18) 1/6 size               |
|             | SPED72HC-18-6-CL | 6       | –             |       |     |      |            |       |       |        | 484           | (18) 1/6 size               |

For total height, add 3 or 6 inches, based on your mounting choice. Depth measurement includes handles.

# SANDWICH PREP

## Mega Top

### DOORS

MAINTAINS PRODUCT TEMPERATURES OF 36-38°F.

| MODEL WIDTH           | MODEL #       | DOORS/SHELVES | VOLTS | HP  | AMPS | CUBIC FEET | WIDTH | DEPTH | HEIGHT | CRATED WEIGHT | STANDARD PANS 4" DEEP |
|-----------------------|---------------|---------------|-------|-----|------|------------|-------|-------|--------|---------------|-----------------------|
| <b>27"</b><br>1 DOOR  | SPE27HC-12M-B | 1/2           | 115   | 1/6 | 2    | 6.91       | 27    | 38.5  | 36.75  | 220           | (12) 1/6 size         |
| <b>32"</b><br>1 DOOR  | SPE32HC-12M   | 1/2           | 115   | 1/6 | 2    | 8.01       | 32    | 38.5  | 39.25  | 246           | (12) 1/6 size         |
| <b>36"</b><br>2 DOORS | SPE36HC-12M   | 2/4           | 115   | 1/6 | 2    | 10.01      | 36    | 38.5  | 39     | 276           | (12) 1/6 size         |
|                       | SPE36HC-15M   |               |       |     |      |            |       |       |        | 274           | (15) 1/6 size         |
| <b>48"</b><br>2 DOORS | SPE48HC-12M   | 2/4           | 115   | 1/6 | 2.2  | 13.01      | 48    | 38.5  | 39.25  | 336           | (12) 1/6 size         |
|                       | SPE48HC-18M   |               |       |     |      |            |       |       |        | 336           | (18) 1/6 size         |
| <b>60"</b><br>2 DOORS | SPE60HC-12M   | 2/4           | 115   | 1/3 | 5.4  | 16.02      | 60    | 38.5  | 39.25  | 342           | (12) 1/6 size         |
|                       | SPE60HC-18M   |               |       |     |      |            |       |       |        | 374           | (18) 1/6 size         |
|                       | SPE60HC-24M   |               |       |     |      |            |       |       |        | 392           | (24) 1/6 size         |
| <b>72"</b><br>3 DOORS | SPE72HC-12M   | 3/6           | 115   | 1/3 | 5.4  | 20.02      | 72    | 38.5  | 39.25  | 432           | (12) 1/6 size         |
|                       | SPE72HC-18M   |               |       |     |      |            |       |       |        | 434           | (18) 1/6 size         |
|                       | SPE72HC-24M   |               |       |     |      |            |       |       |        | 404           | (24) 1/6 size         |
|                       | SPE72HC-30M   |               |       |     |      |            |       |       |        | 446           | (30) 1/6 size         |

| MODEL WIDTH | MODEL #          | DOORS/SHELVES | VOLTS | HP  | AMPS | CUBIC FEET | WIDTH | DEPTH | HEIGHT | CRATED WEIGHT | STANDARD PANS 4" DEEP |
|-------------|------------------|---------------|-------|-----|------|------------|-------|-------|--------|---------------|-----------------------|
| <b>27"</b>  | SPE27HC-12M-B-DS | 1/2           | 115   | 1/6 | 2    | 6.91       | 27    | 48.75 | 40.75  | 244           | (12) 1/6              |
| <b>48"</b>  | SPE48HC-18M-DS   | 2/4           | 115   | 1/6 | 2.2  | 13.01      | 48    | 48.75 | 40.75  | 376           | (18) 1/6 size         |
| <b>60"</b>  | SPE60HC-24M-DS   | 2/4           | 115   | 1/3 | 5.4  | 16.02      | 60    | 48.75 | 40.75  | 430           | (24) 1/6 size         |
| <b>72"</b>  | SPE72HC-30M-DS   | 3/6           | 115   | 1/3 | 5.4  | 20.02      | 72    | 48.75 | 40.75  | 504           | (30) 1/6 size         |

| MODEL WIDTH | MODEL #         | DOORS/SHELVES | VOLTS | HP  | AMPS | CUBIC FEET | WIDTH | DEPTH | HEIGHT | CRATED WEIGHT | STANDARD PANS 4" DEEP |
|-------------|-----------------|---------------|-------|-----|------|------------|-------|-------|--------|---------------|-----------------------|
| <b>36"</b>  | SPE36HC-15M-STL | 2/4           | 115   | 1/6 | 2    | 10.01      | 36    | 38.38 | 53.75  | 274           | (15) 1/6 size         |
| <b>48"</b>  | SPE48HC-18M-STL | 2/4           | 115   | 1/6 | 2.2  | 13.01      | 48    | 38.38 | 53.75  | 354           | (18) 1/6 size         |
| <b>60"</b>  | SPE60HC-24M-STL | 2/4           | 115   | 1/3 | 5.4  | 16.02      | 60    | 38.38 | 55.25  | 414           | (24) 1/6 size         |
| <b>72"</b>  | SPE72HC-30M-STL | 3/6           | 115   | 1/3 | 5.4  | 20.02      | 72    | 38.38 | 56     | 464           | (30) 1/6 size         |

Depth measurement includes handles.  
For total height, add 3 or 6 inches, based on your mounting choice.



## DRAWERS

MAINTAINS PRODUCT TEMPERATURES OF 36-38°F.

| MODEL WIDTH | MODEL #        | DRAWERS | DOORS/<br>SHELVES | VOLTS | HP  | AMPS | CUBIC<br>FEET | WIDTH | DEPTH | HEIGHT | CRATED<br>WEIGHT | STANDARD PANS<br>4" DEEP    |
|-------------|----------------|---------|-------------------|-------|-----|------|---------------|-------|-------|--------|------------------|-----------------------------|
| 27"         | SPED27HC-12M   | 2       | –                 | 115   | 1/6 | 2    | 6.91          | 27    | 38.38 | 37     | 250              | (9) 1/6 size & (3) 1/9 size |
|             | SPED27HC-12M-B | 2       | –                 |       |     |      |               |       |       |        | 238              | (12) 1/6 size               |
| 32"         | SPED32HC-12M-2 | 2       | –                 | 115   | 1/6 | 2    | 8.01          | 32    | 38.5  | 39.25  | 280              | (12) 1/6 size               |
| 36"         | SPED36HC-12M-2 | 2       | –                 | 115   | 1/6 | 2    | 10.01         | 36    | 38.38 | 37     | 300              | (12) 1/6 size               |
|             | SPED36HC-15M-2 | 2       | –                 |       |     |      |               |       |       |        | 302              | (15) 1/6 size               |
| 48"         | SPED48HC-12M-2 | 2       | 1/2               | 115   | 1/6 | 2.2  | 13.01         | 48    | 38.38 | 37     | 354              | (12) 1/6 size               |
|             | SPED48HC-12M-4 | 4       | –                 |       |     |      |               |       |       |        | 360              | (12) 1/6 size               |
|             | SPED48HC-18M-2 | 2       | 1/2               | 115   | 1/6 | 2.2  | 13.01         | 48    | 38.38 | 37     | 366              | (18) 1/6 size               |
|             | SPED48HC-18M-4 | 4       | –                 |       |     |      |               |       |       |        | 394              | (18) 1/6 size               |
| 60"         | SPED60HC-12M-2 | 2       | 1/2               | 115   | 1/3 | 5.4  | 16.02         | 60    | 38.38 | 37     | 390              | (12) 1/6 size               |
|             | SPED60HC-12M-4 | 4       | –                 |       |     |      |               |       |       |        | 436              | (12) 1/6 size               |
|             | SPED60HC-18M-2 | 2       | 1/2               | 115   | 1/3 | 5.4  | 16.02         | 60    | 38.38 | 37     | 406              | (18) 1/6 size               |
|             | SPED60HC-18M-4 | 4       | –                 |       |     |      |               |       |       |        | 456              | (18) 1/6 size               |
|             | SPED60HC-24M-2 | 2       | 1/2               | 115   | 1/3 | 5.4  | 16.02         | 60    | 38.38 | 37     | 414              | (24) 1/6 size               |
|             | SPED60HC-24M-4 | 4       | –                 |       |     |      |               |       |       |        | 456              | (24) 1/6 size               |
| 72"         | SPED72HC-12M-2 | 2       | 2/4               | 115   | 1/3 | 5.4  | 20.02         | 72    | 38.38 | 37     | 482              | (12) 1/6 size               |
|             | SPED72HC-12M-4 | 4       | 1/2               |       |     |      |               |       |       |        | 484              | (12) 1/6 size               |
|             | SPED72HC-12M-6 | 6       | –                 |       |     |      |               |       |       |        | 484              | (12) 1/6 size               |
|             | SPED72HC-18M-2 | 2       | 2/4               | 115   | 1/3 | 5.4  | 20.02         | 72    | 38.38 | 37     | 450              | (18) 1/6 size               |
|             | SPED72HC-18M-4 | 4       | 1/2               |       |     |      |               |       |       |        | 450              | (18) 1/6 size               |
|             | SPED72HC-18M-6 | 6       | –                 |       |     |      |               |       |       |        | 505              | (18) 1/6 size               |
|             | SPED72HC-24M-2 | 2       | 2/4               | 115   | 1/3 | 5.4  | 20.02         | 72    | 38.38 | 37     | 470              | (24) 1/6 size               |
|             | SPED72HC-24M-4 | 4       | 1/2               |       |     |      |               |       |       |        | 492              | (24) 1/6 size               |
|             | SPED72HC-24M-6 | 6       | –                 |       |     |      |               |       |       |        | 496              | (24) 1/6 size               |
|             | SPED72HC-30M-2 | 2       | 2/4               | 115   | 1/3 | 5.4  | 20.02         | 72    | 38.38 | 37     | 480              | (30) 1/6 size               |
|             | SPED72HC-30M-4 | 4       | 1/2               |       |     |      |               |       |       |        | 508              | (30) 1/6 size               |
|             | SPED72HC-30M-6 | 6       | –                 |       |     |      |               |       |       |        | 528              | (30) 1/6 size               |

Depth measurement includes handles.  
For total height, add 3 or 6 inches, based on your mounting choice.

# SANDWICH PREP

## Clear Lid Mega Top

### DOORS

MAINTAINS PRODUCT TEMPERATURES OF 36-38°F.

| MODEL WIDTH           | MODEL #          | DOORS/SHELVES | VOLTS | HP  | AMPS | CUBIC FEET | WIDTH | DEPTH | HEIGHT | CRATED WEIGHT | STANDARD PANS 4" DEEP |
|-----------------------|------------------|---------------|-------|-----|------|------------|-------|-------|--------|---------------|-----------------------|
| <b>27"</b><br>1 DOOR  | SPE27HC-12M-B-CL | 1/2           | 115   | 1/6 | 2    | 6.91       | 27    | 38.5  | 51.25  | 220           | (12) 1/6 size         |
| <b>32"</b><br>1 DOOR  | SPE32HC-12M-CL   | 1/2           | 115   | 1/6 | 2    | 8.01       | 32    | 38.5  | 50.88  | 246           | (12) 1/6 size         |
| <b>36"</b><br>2 DOORS | SPE36HC-12M-CL   | 2/4           | 115   | 1/6 | 2    | 10.01      | 36    | 38.5  | 50.75  | 276           | (12) 1/6 size         |
|                       | SPE36HC-15M-CL   |               |       |     |      |            |       |       |        | 274           | (15) 1/6 size         |
| <b>48"</b><br>2 DOORS | SPE48HC-12M-CL   | 2/4           | 115   | 1/6 | 2.2  | 13.01      | 48    | 38.5  | 50.75  | 336           | (12) 1/6 size         |
|                       | SPE48HC-18M-CL   |               |       |     |      |            |       |       |        | 336           | (18) 1/6 size         |
| <b>60"</b><br>2 DOORS | SPE60HC-12M-CL   | 2/4           | 115   | 1/3 | 5.4  | 16.02      | 60    | 38.5  | 50.88  | 342           | (12) 1/6 size         |
|                       | SPE60HC-18M-CL   |               |       |     |      |            |       |       |        | 374           | (18) 1/6 size         |
|                       | SPE60HC-24M-CL   |               |       |     |      |            |       |       |        | 392           | (24) 1/6 size         |
| <b>72"</b><br>3 DOORS | SPE72HC-12M-CL   | 3/6           | 115   | 1/3 | 5.4  | 20.02      | 72    | 38.5  | 50.75  | 432           | (12) 1/6 size         |
|                       | SPE72HC-18M-CL   |               |       |     |      |            |       |       |        | 434           | (18) 1/6 size         |
|                       | SPE72HC-24M-CL   |               |       |     |      |            |       |       |        | 404           | (24) 1/6 size         |
|                       | SPE72HC-30M-CL   |               |       |     |      |            |       |       |        | 446           | (30) 1/6 size         |

NEW

*Depth measurement includes handles.  
For total height, add 3 or 6 inches, based on your mounting choice.*

| AVAILABLE OPTIONS                           |                         |
|---|-------------------------|
| SUFFIX                                      | OPTION                  |
| <b>24</b>                                   | Left hand hinge doors   |
| <b>R</b>                                    | Remote models available |
| Append suffix to model # when placing order |                         |

## CLEAR LIDS



## DRAWERS

MAINTAINS PRODUCT TEMPERATURES OF 36-38°F.

| MODEL WIDTH | MODEL #           | DRAWERS | DOORS/<br>SHELVES | VOLTS | HP  | AMPS | CUBIC<br>FEET | WIDTH | DEPTH | HEIGHT | CRATED<br>WEIGHT | STANDARD PANS<br>4" DEEP    |
|-------------|-------------------|---------|-------------------|-------|-----|------|---------------|-------|-------|--------|------------------|-----------------------------|
| 27"         | SPED27HC-12M-CL   | 2       | –                 | 115   | 1/6 | 2    | 6.91          | 27    | 38.38 | 51.25  | 250              | (9) 1/6 size & (3) 1/9 size |
|             | SPED27HC-12M-B-CL | 2       | –                 |       |     |      |               |       |       |        | 238              | (12) 1/6 size               |
| 32"         | SPED32HC-12M-2-CL | 2       | –                 | 115   | 1/6 | 2    | 8.01          | 32    | 38.5  | 50.88  | 280              | (12) 1/6 size               |
| 36"         | SPED36HC-12M-2-CL | 2       | –                 | 115   | 1/6 | 2    | 10.01         | 36    | 38.38 | 50.75  | 300              | (12) 1/6 size               |
|             | SPED36HC-15M-2-CL | 2       | –                 |       |     |      |               |       |       |        | 302              | (15) 1/6 size               |
| 48"         | SPED48HC-12M-2-CL | 2       | 1/2               | 115   | 1/6 | 2.2  | 13.01         | 48    | 38.38 | 50.75  | 354              | (12) 1/6 size               |
|             | SPED48HC-12M-4-CL | 4       | –                 |       |     |      |               |       |       |        | 360              | (12) 1/6 size               |
|             | SPED48HC-18M-2-CL | 2       | 1/2               | 115   | 1/6 | 2.2  | 13.01         | 48    | 38.38 | 50.75  | 366              | (18) 1/6 size               |
|             | SPED48HC-18M-4-CL | 4       | –                 |       |     |      |               |       |       |        | 394              | (18) 1/6 size               |
| 60"         | SPED60HC-12M-2-CL | 2       | 1/2               | 115   | 1/3 | 5.4  | 16.02         | 60    | 38.38 | 50.88  | 390              | (12) 1/6 size               |
|             | SPED60HC-12M-4-CL | 4       | –                 |       |     |      |               |       |       |        | 436              | (12) 1/6 size               |
|             | SPED60HC-18M-2-CL | 2       | 1/2               | 115   | 1/3 | 5.4  | 16.02         | 60    | 38.38 | 50.88  | 406              | (18) 1/6 size               |
|             | SPED60HC-18M-4-CL | 4       | –                 |       |     |      |               |       |       |        | 456              | (18) 1/6 size               |
|             | SPED60HC-24M-2-CL | 2       | 1/2               | 115   | 1/3 | 5.4  | 16.02         | 60    | 38.38 | 50.88  | 414              | (24) 1/6 size               |
|             | SPED60HC-24M-4-CL | 4       | –                 |       |     |      |               |       |       |        | 456              | (24) 1/6 size               |
| 72"         | SPED72HC-12M-2-CL | 2       | 2/4               | 115   | 1/3 | 5.4  | 20.02         | 72    | 38.38 | 50.75  | 482              | (12) 1/6 size               |
|             | SPED72HC-12M-4-CL | 4       | 1/2               |       |     |      |               |       |       |        | 484              | (12) 1/6 size               |
|             | SPED72HC-12M-6-CL | 6       | –                 |       |     |      |               |       |       |        | 484              | (12) 1/6 size               |
|             | SPED72HC-18M-2-CL | 2       | 2/4               | 115   | 1/3 | 5.4  | 20.02         | 72    | 38.38 | 50.75  | 450              | (18) 1/6 size               |
|             | SPED72HC-18M-4-CL | 4       | 1/2               |       |     |      |               |       |       |        | 450              | (18) 1/6 size               |
|             | SPED72HC-18M-6-CL | 6       | –                 |       |     |      |               |       |       |        | 505              | (18) 1/6 size               |
|             | SPED72HC-24M-2-CL | 2       | 2/4               | 115   | 1/3 | 5.4  | 20.02         | 72    | 38.38 | 50.75  | 470              | (24) 1/6 size               |
|             | SPED72HC-24M-4-CL | 4       | 1/2               |       |     |      |               |       |       |        | 492              | (24) 1/6 size               |
|             | SPED72HC-24M-6-CL | 6       | –                 |       |     |      |               |       |       |        | 496              | (24) 1/6 size               |
|             | SPED72HC-30M-2-CL | 2       | 2/4               | 115   | 1/3 | 5.4  | 20.02         | 72    | 38.38 | 50.75  | 480              | (30) 1/6 size               |
|             | SPED72HC-30M-4-CL | 4       | 1/2               |       |     |      |               |       |       |        | 508              | (30) 1/6 size               |
|             | SPED72HC-30M-6-CL | 6       | –                 |       |     |      |               |       |       |        | 528              | (30) 1/6 size               |

NEW

Depth measurement includes handles.  
For total height, add 3 or 6 inches, based on your mounting choice.

# SANDWICH PREP

## Cutting Top

17" DEEP REVERSIBLE CUTTING BOARD

### DOORS

MAINTAINS PRODUCT TEMPERATURES OF 36-38°F.

| MODEL WIDTH           | MODEL #     | DOORS/SHELVES | VOLTS | HP  | AMPS | CUBIC FEET | WIDTH | DEPTH | HEIGHT | CRATED WEIGHT | STANDARD PANS 4" DEEP       |
|-----------------------|-------------|---------------|-------|-----|------|------------|-------|-------|--------|---------------|-----------------------------|
| <b>27"</b><br>1 DOOR  | SPE27HC-C   | 1/2           | 115   | 1/6 | 2    | 6.91       | 27    | 38.38 | 39.38  | 212           | (6) 1/6 size & (2) 1/9 size |
|                       | SPE27HC-C-B |               |       |     |      |            |       |       |        | 212           | (8) 1/6 size                |
| <b>36"</b><br>2 DOORS | SPE36HC-08C | 2/4           | 115   | 1/6 | 2    | 10.01      | 36    | 38.38 | 39     | 268           | (8) 1/6 size                |
|                       | SPE36HC-10C |               |       |     |      |            |       |       |        | 276           | (10) 1/6 size               |
| <b>48"</b><br>2 DOORS | SPE48HC-08C | 2/4           | 115   | 1/6 | 2.2  | 13.01      | 48    | 38.38 | 39.25  | 326           | (8) 1/6 size                |
|                       | SPE48HC-10C |               |       |     |      |            |       |       |        | 322           | (10) 1/6 size               |
|                       | SPE48HC-12C |               |       |     |      |            |       |       |        | 326           | (12) 1/6 size               |
| <b>60"</b><br>2 DOORS | SPE60HC-08C | 2/4           | 115   | 1/3 | 5.4  | 16.02      | 60    | 38.38 | 39     | 332           | (8) 1/6 size                |
|                       | SPE60HC-10C |               |       |     |      |            |       |       |        | 334           | (10) 1/6 size               |
|                       | SPE60HC-12C |               |       |     |      |            |       |       |        | 342           | (12) 1/6 size               |
|                       | SPE60HC-16C |               |       |     |      |            |       |       |        | 376           | (16) 1/6 size               |
| <b>72"</b><br>3 DOORS | SPE72HC-08C | 3/6           | 115   | 1/3 | 5.4  | 20.02      | 72    | 38.38 | 39     | 396           | (8) 1/6 size                |
|                       | SPE72HC-10C |               |       |     |      |            |       |       |        | 427           | (10) 1/6 size               |
|                       | SPE72HC-12C |               |       |     |      |            |       |       |        | 420           | (12) 1/6 size               |
|                       | SPE72HC-18C |               |       |     |      |            |       |       |        | 438           | (18) 1/6 size               |

Depth measurement includes handles.  
For total height, add 3 or 6 inches, based on your mounting choice.

### AVAILABLE OPTIONS

| SUFFIX                                      | OPTION                  |
|---|-------------------------|
| <b>24</b>                                   | Left hand hinge doors   |
| <b>R</b>                                    | Remote models available |
| Append suffix to model # when placing order |                         |

### DRAWER PAN CONFIGURATIONS for all SPED units

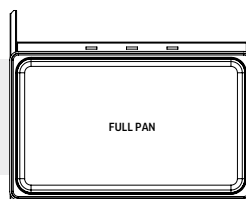

SPE027 / SPE032 / SPE060

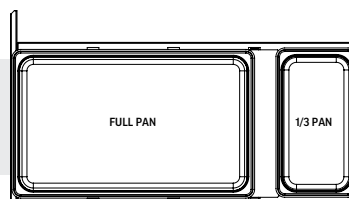

SPE036

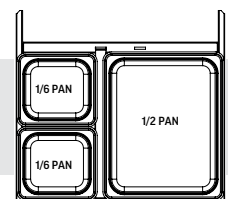

SPE048 / SPE072

## DRAWERS

MAINTAINS PRODUCT TEMPERATURES OF 36-38°F.

| MODEL WIDTH | MODEL #        | DRAWERS | DOORS/<br>SHELVES | VOLTS | HP  | AMPS | CUBIC<br>FEET | WIDTH | DEPTH | HEIGHT | CRATED<br>WEIGHT | STANDARD PANS<br>4" DEEP    |
|-------------|----------------|---------|-------------------|-------|-----|------|---------------|-------|-------|--------|------------------|-----------------------------|
| 27"         | SPED27HC-C     | 2       | –                 | 115   | 1/6 | 2    | 6.91          | 27    | 38.38 | 39.38  | 238              | (6) 1/6 size & (2) 1/9 size |
|             | SPED27HC-C-B   | 2       | –                 |       |     |      |               |       |       |        | 238              | (8) 1/6 size                |
| 36"         | SPED36HC-08C-2 | 2       | –                 | 115   | 1/6 | 2    | 10.01         | 36    | 38.25 | 39     | 276              | (8) 1/6 size                |
|             | SPED36HC-10C-2 | 2       | –                 |       |     |      |               |       |       |        | 278              | (10) 1/6 size               |
| 48"         | SPED48HC-08C-2 | 2       | 1/2               | 115   | 1/6 | 2.2  | 13.01         | 48    | 38.38 | 39.25  | 358              | (8) 1/6 size                |
|             | SPED48HC-08C-4 | 4       | –                 |       |     |      |               |       |       |        | 358              | (8) 1/6 size                |
|             | SPED48HC-10C-2 | 2       | 1/2               | 115   | 1/6 | 2.2  | 13.01         | 48    | 38.38 | 39.25  | 326              | (10) 1/6 size               |
|             | SPED48HC-10C-4 | 4       | –                 |       |     |      |               |       |       |        | 326              | (10) 1/6 size               |
|             | SPED48HC-12C-2 | 2       | 1/2               | 115   | 1/6 | 2.2  | 13.01         | 48    | 38.38 | 39.25  | 348              | (12) 1/6 size               |
|             | SPED48HC-12C-4 | 4       | –                 |       |     |      |               |       |       |        | 380              | (12) 1/6 size               |
| 60"         | SPED60HC-08C-2 | 2       | 1/2               | 115   | 1/3 | 5.4  | 16.02         | 60    | 38.38 | 39     | 404              | (8) 1/6 size                |
|             | SPED60HC-08C-4 | 4       | –                 |       |     |      |               |       |       |        | 404              | (8) 1/6 size                |
|             | SPED60HC-10C-2 | 2       | 1/2               | 115   | 1/3 | 5.4  | 16.02         | 60    | 38.38 | 39     | 406              | (10) 1/6 size               |
|             | SPED60HC-10C-4 | 4       | –                 |       |     |      |               |       |       |        | 406              | (10) 1/6 size               |
|             | SPED60HC-12C-2 | 2       | 1/2               | 115   | 1/3 | 5.4  | 16.02         | 60    | 38.38 | 39     | 402              | (12) 1/6 size               |
|             | SPED60HC-12C-4 | 4       | –                 |       |     |      |               |       |       |        | 368              | (12) 1/6 size               |
|             | SPED60HC-16C-2 | 2       | 1/2               | 115   | 1/3 | 5.4  | 16.02         | 60    | 38.38 | 39     | 420              | (16) 1/6 size               |
|             | SPED60HC-16C-4 | 4       | –                 |       |     |      |               |       |       |        | 456              | (16) 1/6 size               |
| 72"         | SPED72HC-08C-2 | 2       | 2/4               | 115   | 1/3 | 5.4  | 20.02         | 72    | 38.38 | 39.13  | 450              | (8) 1/6 size                |
|             | SPED72HC-08C-4 | 4       | 1/2               |       |     |      |               |       |       |        | 454              | (8) 1/6 size                |
|             | SPED72HC-08C-6 | 6       | –                 |       |     |      |               |       |       |        | 456              | (8) 1/6 size                |
|             | SPED72HC-10C-2 | 2       | 2/4               | 115   | 1/3 | 5.4  | 20.02         | 72    | 38.38 | 39.13  | 448              | (10) 1/6 size               |
|             | SPED72HC-10C-4 | 4       | 1/2               |       |     |      |               |       |       |        | 450              | (10) 1/6 size               |
|             | SPED72HC-10C-6 | 6       | –                 |       |     |      |               |       |       |        | 452              | (10) 1/6 size               |
|             | SPED72HC-12C-2 | 2       | 2/4               | 115   | 1/3 | 5.4  | 20.02         | 72    | 38.38 | 39.13  | 418              | (12) 1/6 size               |
|             | SPED72HC-12C-4 | 4       | 1/2               |       |     |      |               |       |       |        | 442              | (12) 1/6 size               |
|             | SPED72HC-12C-6 | 6       | –                 |       |     |      |               |       |       |        | 508              | (12) 1/6 size               |
|             | SPED72HC-18C-2 | 2       | 2/4               | 115   | 1/3 | 5.4  | 20.02         | 72    | 38.38 | 39.13  | 468              | (18) 1/6 size               |
|             | SPED72HC-18C-4 | 4       | 1/2               |       |     |      |               |       |       |        | 486              | (18) 1/6 size               |
|             | SPED72HC-18C-6 | 6       | –                 |       |     |      |               |       |       |        | 538              | (18) 1/6 size               |

Depth measurement includes handles.  
For total height, add 3 or 6 inches, based on your mounting choice.

# SANDWICH PREP

## Pan Configurations

### Standard Top

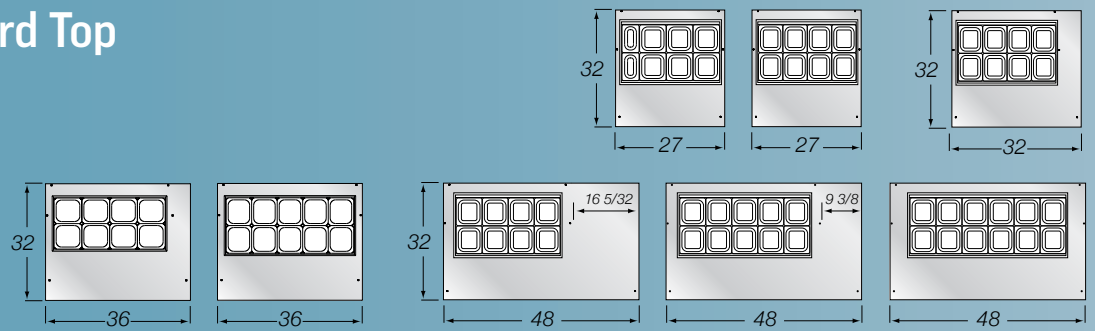

### Mega Top

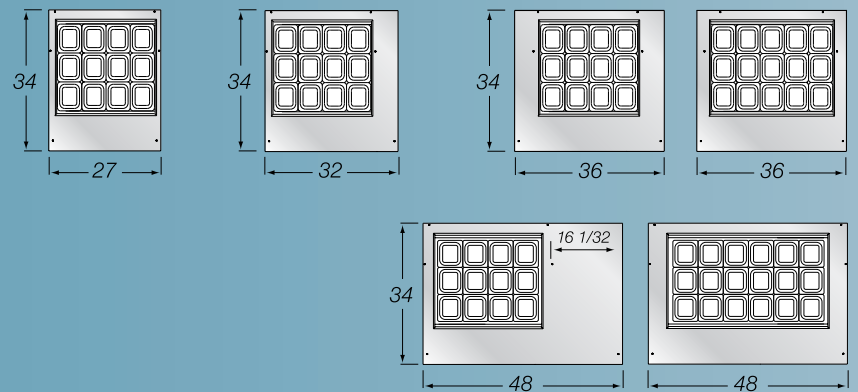

### Cutting Top

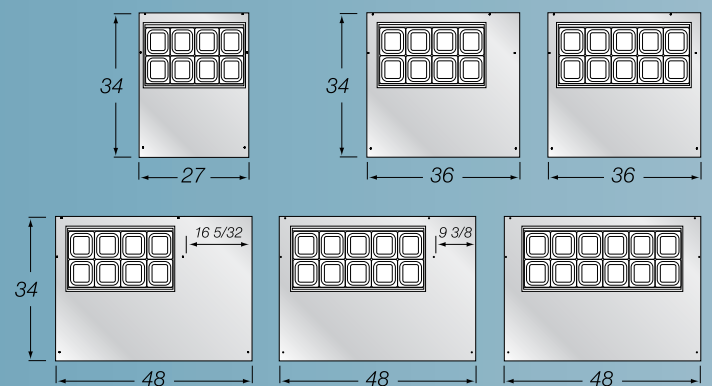

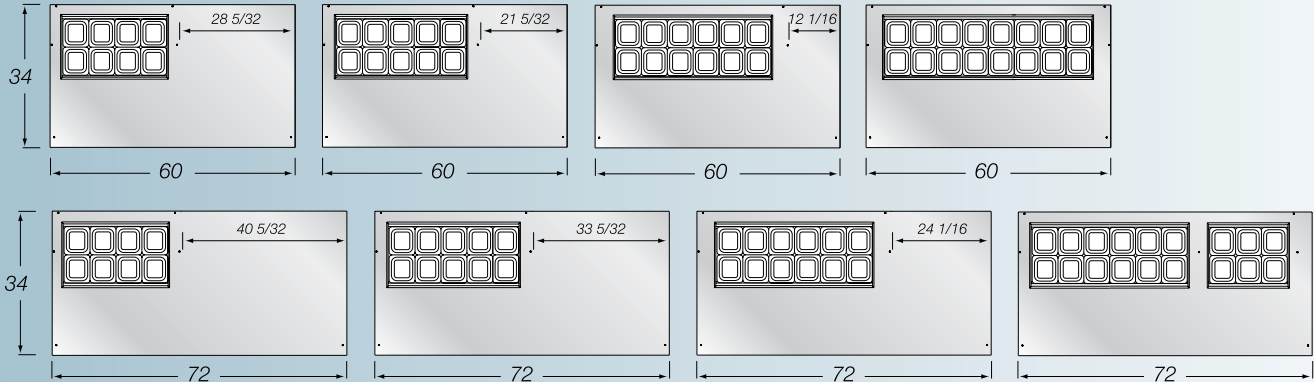
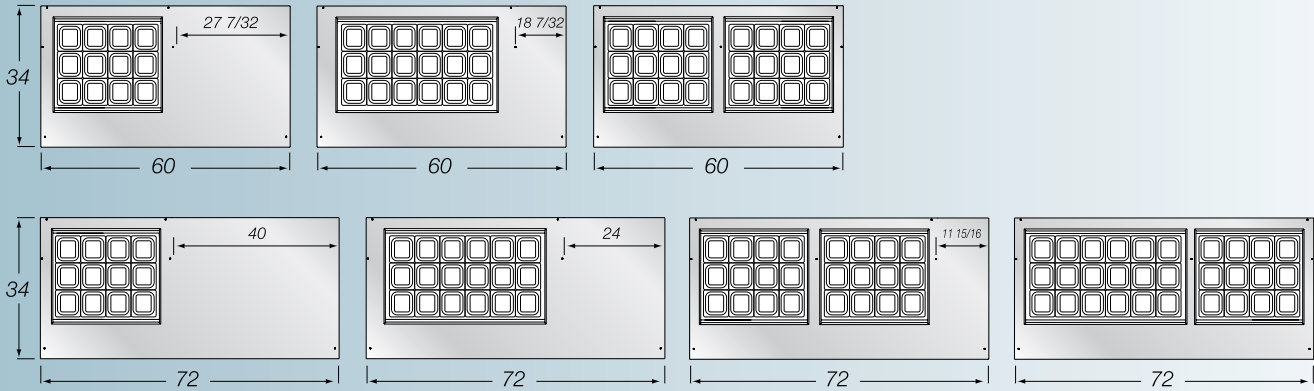
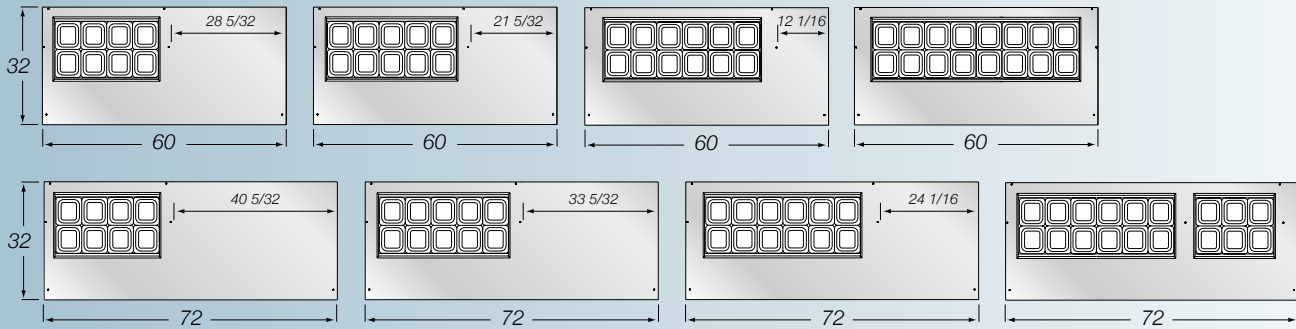

# PIZZA PREP

**REDESIGNED  
FOR 2019**

**New duct system features uniform airflow distribution**

over evaporator coil and throughout raised rail

**Newly designed easy-open lid system**

provides easier accessibility

**Electronic controller with smart-defrost**

**Electrical defrost heater**

terminates defrost sooner, reducing product instability

**Right or left compressor placement**

specify at time of order

**Field reversible doors**

with 120 degree stay open feature

**Heavy-duty aluminum pan liner**

is easy to clean and prevents spills from falling into cabinet

**Accommodates up to 6" deep food service pans**

Not included

**Improved serviceability**

Removable service panel for easy access to refrigeration system

**Featuring environmentally friendly  
energy efficient R290 refrigerant**



**DESIGNED TO PERFORM IN HIGH AMBIENT CONDITIONS**

**LOW-PROFILE DESIGN FOR ENHANCED ERGONOMICS AND PRODUCT DISPLAY**

**IMPROVED AIRFLOW MAINTAINS CONSISTENT PAN TEMPERATURE IN TOP RAIL**



**3 DRAWERS IN SINGLE SECTION**  
available on all sizes



**CLEAR LIDS AVAILABLE**  
for optimized product display

**ACCESS OPTIONS**

- Doors
- Drawers (stacks of 2 or 3)

**LID OPTIONS**

- Clear lids
- Removable lids

**AGENCY CERTIFICATIONS**





# Pizza & Deli Prep Tables



## EXTERIOR FINISHES

- Stainless steel with galvanized back
- Stainless steel with stainless back

## INTERIOR FINISHES

- Corrosion-resistant aluminum
- Stainless

## AVAILABLE ACCESSORIES

- Composite cutting boards
- Bun tray racks
- Overshelf
- Locks
- Additional shelves



## AVAILABLE OPTIONS

- Left hand hinge doors
- Remote models available
- Alternate compressor locations

## MOUNTING OPTIONS

- 3" casters (standard)
- 6" casters
- 6" legs

# Pizza Prep

## DOORS

MAINTAINS PRODUCT TEMPERATURES OF 36-38°F.

| MODEL WIDTH | MODEL # | DOORS/SHELVES | VOLTS | HP  | AMPS | CUBIC FEET | WIDTH | DEPTH | HEIGHT | CRATED WEIGHT | FULL SIZE PAN CAPACITY |
|-------------|---------|---------------|-------|-----|------|------------|-------|-------|--------|---------------|------------------------|
| <b>46"</b>  | DP46HC  | 1/2           | 115   | 1/3 | 4.5  | 11.91      | 46    | 36.88 | 49.38  | 336           | 2                      |
| <b>60"</b>  | DP60HC  | 2/4           | 115   | 1/3 | 4.5  | 17         | 60    | 37    | 49.5   | 440           | 3                      |
| <b>67"</b>  | DP67HC  | 2/4           | 115   | 1/3 | 4.5  | 20.68      | 67    | 37    | 49.25  | 440           | 3                      |
| <b>72"</b>  | DP72HC  | 2/4           | 115   | 1/3 | 4.5  | 21.87      | 72    | 37    | 49.75  | 438           | 3                      |
| <b>93"</b>  | DP93HC  | 3/6           | 115   | 1/2 | 7.8  | 31.54      | 93    | 37    | 49.38  | 574           | 4                      |
| <b>119"</b> | DP119HC | 4/8           | 115   | 1/2 | 7.8  | 42.2       | 119   | 37    | 49.38  | 712           | 5                      |

NEW

NEW

*Depth measurement includes cutting board.  
For total height, add 3 or 6 inches, based on your mounting choice.*



DPD72HC-3 (see page 90)

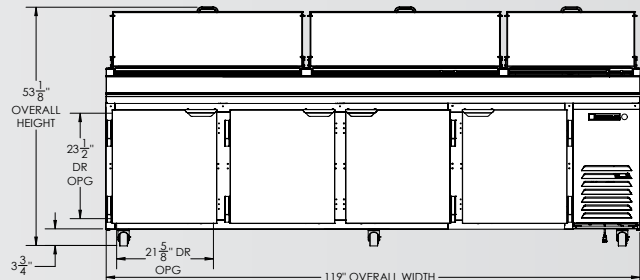
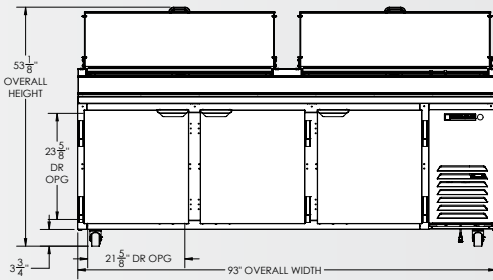
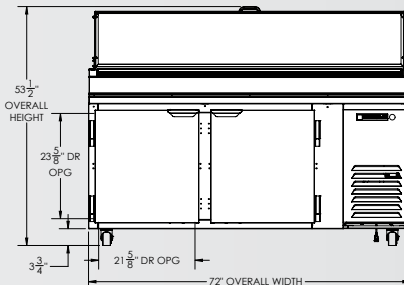
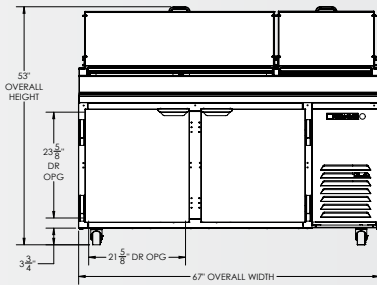
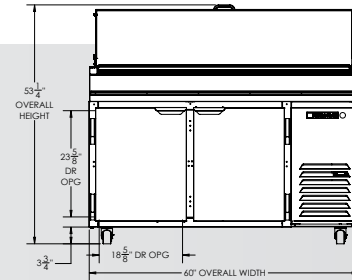
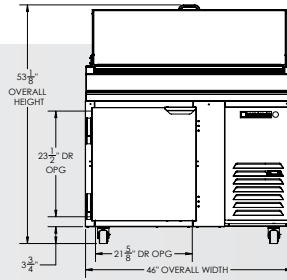
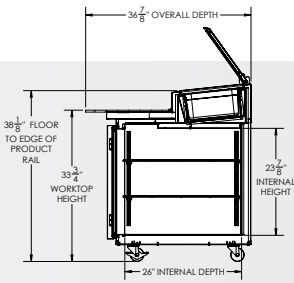

**PAN CONFIGURATIONS**  
for DP and DPD units

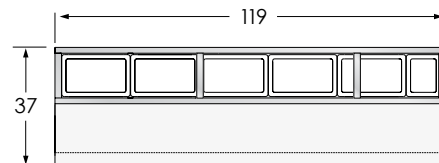
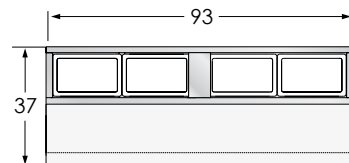
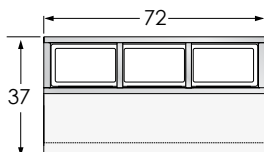
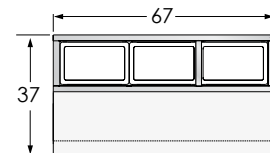
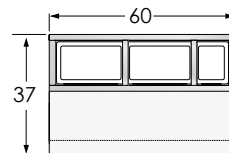
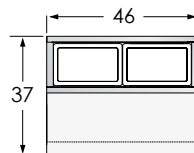

# Pizza Prep

## DRAWERS

MAINTAINS PRODUCT TEMPERATURES OF 36-38°F.

| MODEL WIDTH | MODEL #     | DRAWERS | DOORS/SHELVES | VOLTS | HP  | AMPS | CUBIC FEET | WIDTH | DEPTH | HEIGHT | CRATED WEIGHT | FULL SIZE PAN CAPACITY |
|-------------|-------------|---------|---------------|-------|-----|------|------------|-------|-------|--------|---------------|------------------------|
| 46"         | DPD46HC-2   | 2       | -             | 115   | 1/3 | 4.5  | 11.91      | 46    | 37    | 49.38  | 311           | 2                      |
|             | DPD46HC-3   | 3       |               |       |     |      |            |       |       |        |               |                        |
| 60"         | DPD60HC-2   | 2       | -             | 115   | 1/3 | 4.5  | 17         | 60    | 37    | 49.50  | 454           | 2                      |
|             | DPD60HC-3   | 3       |               |       |     |      |            |       |       |        |               |                        |
| 67"         | DPD67HC-2   | 2       | 1/2           | 115   | 1/3 | 4.5  | 20.68      | 67    | 37    | 49.25  | 484           | 3                      |
|             | DPD67HC-3   | 3       |               |       |     |      |            |       |       |        |               |                        |
|             | DPD67HC-4   | 4       | -             |       |     |      |            |       |       |        |               |                        |
|             | DPD67HC-6   | 6       |               |       |     |      |            |       |       |        |               |                        |
| 72"         | DPD72HC-2   | 2       | 1/2           | 115   | 1/3 | 4.5  | 21.87      | 72    | 37    | 49.63  | 540           | 3                      |
|             | DPD72HC-3   | 3       |               |       |     |      |            |       |       |        |               |                        |
|             | DPD72HC-4   | 4       | -             |       |     |      |            |       |       |        |               |                        |
|             | DPD72HC-6   | 6       |               |       |     |      |            |       |       |        |               |                        |
| 93"         | DPD93HC-2   | 2       | 2/4           | 115   | 1/2 | 7.8  | 31.54      | 93    | 37    | 49.38  | 600           | 4                      |
|             | DPD93HC-3   | 3       |               |       |     |      |            |       |       |        |               |                        |
|             | DPD93HC-4   | 4       | 1/2           |       |     |      |            |       |       |        |               |                        |
|             | DPD93HC-6   | 6       | -             |       |     |      |            |       |       |        |               |                        |
|             | DPD93HC-9   | 9       |               |       |     |      |            |       |       |        |               |                        |
| 119"        | DPD119HC-2  | 2       | 3/6           | 115   | 1/2 | 7.8  | 42.2       | 119   | 37    | 49.38  | 703           | 5                      |
|             | DPD119HC-3  | 3       | 3/6           |       |     |      |            |       |       |        |               |                        |
|             | DPD119HC-4  | 4       | 2/4           |       |     |      |            |       |       |        |               |                        |
|             | DPD119HC-6  | 6       | 1/2           |       |     |      |            |       |       |        |               |                        |
|             | DPD119HC-6T | 6       | 2/4           |       |     |      |            |       |       |        |               |                        |
|             | DPD119HC-8  | 8       | -             |       |     |      |            |       |       |        |               |                        |
|             | DPD119HC-9  | 9       | 1/2           |       |     |      |            |       |       |        |               |                        |
|             | DPD119HC-12 | 12      | -             |       |     |      |            |       |       |        |               |                        |

Depth measurement includes handles. For total height, add 3 or 6 inches, based on your mounting choice.

### DRAWER PAN CONFIGURATIONS for DPD units

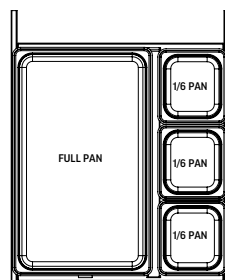

DPD46 / DPD67 / DPD93 / DPD119

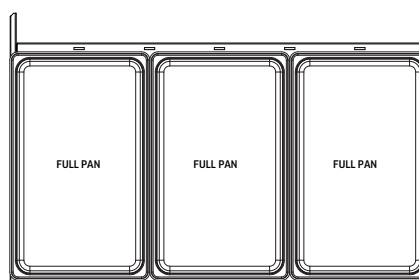

DPD60

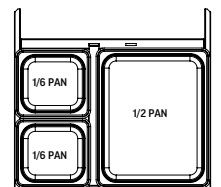

DPD72

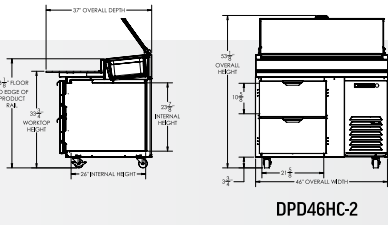

DPD46HC-3

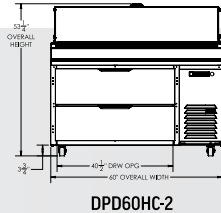

DPD60HC-3

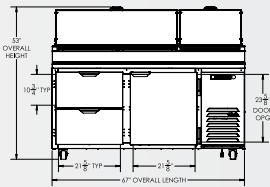

DPD67HC-2

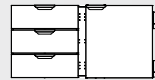

DPD67HC-3

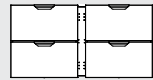

DPD67HC-4

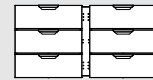

DPD67HC-6

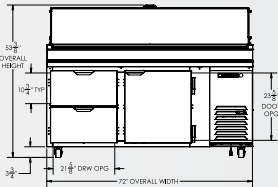

DPD72HC-2

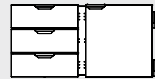

DPD72HC-3

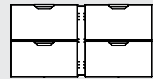

DPD72HC-4

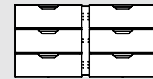

DPD72HC-6

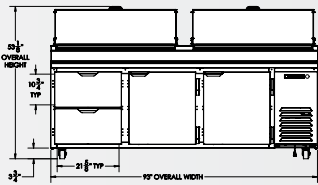

DPD93HC-2

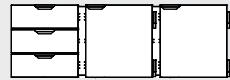

DPD93HC-3

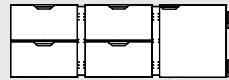

DPD93HC-4

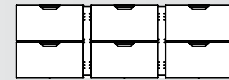

DPD93HC-6

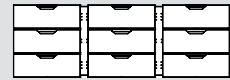

DPD93HC-9

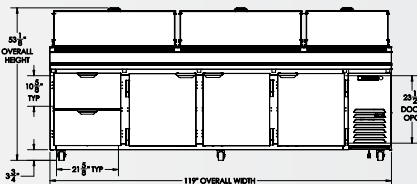

DPD119HC-2

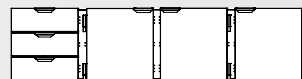

DPD119HC-3

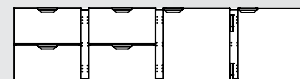

DPD119HC-4

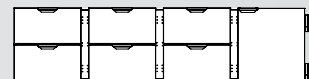

DPD119HC-6



DPD119HC-6T

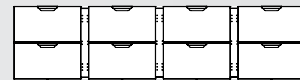

DPD119HC-8

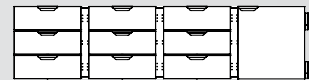

DPD119HC-9

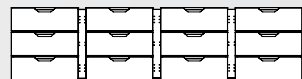

DPD119HC-12

# Food Prep Table Accessories

| DESCRIPTION                                     | UNIT(S)                       | PART NUMBER   |
|---|-------------------------------|---------------|
| <b>SHELVING / ORGANIZERS</b>                    |                               |               |
| Epoxy Coated Wire Shelf (Large)                 | SPE27/27-12M/27C              | 403-826B      |
| Epoxy Coated Wire Shelf (Small)                 | SPE27/SPE27-12M/SPE27C        | 403-912D-01   |
| Epoxy Coated Wire Shelf (Large)                 | SPE36/SPE36M/SPE36C           | 403-911D-01   |
| Epoxy Coated Wire Shelf (Small)                 | SPE36/SPE36M/SPE36C           | 403-915D-01   |
| Epoxy Coated Wire Shelf (Large)                 | SPE48/48M/48C                 | 403-828B      |
| Epoxy Coated Wire Shelf (Small)                 | SPE48/SPE48M/SPE48C           | 403-913D-01   |
| Epoxy Coated Wire Shelf (Large)                 | SPE60/60M/60C                 | 403-829B      |
| Epoxy Coated Wire Shelf (Small)                 | SPE60/SPE60M/SPE60C           | 403-914D-01   |
| Epoxy Coated Ctr Section Wire Shelf (Large)     | SPE72/72M/72C                 | 403-827B      |
| Epoxy Coated Wire Shelf L&R (Large)             | SPE72/72M/72C                 | 403-828B      |
| Epoxy Coated Ctr Section Wire Shelf (Small)     | SPE72/SPE72M/SPE72C           | 403-912D-01   |
| Epoxy Coated Wire Shelf L&R (Small)             | SPE72/SPE72M/SPE72C           | 403-913D-01   |
| Shelf Clip                                      | All SPE/SPED/DP/DPD           | 403-169A      |
| Epoxy Coated Large Shelf                        | SPE27                         | 403-722C      |
| Epoxy Coated Small Shelf                        | SPE27                         | 403-721C      |
| Epoxy Coated Large Shelf                        | SPE36                         | 403-723C      |
| Epoxy Coated Small Shelf                        | SPE36                         | 403-721C      |
| Epoxy Coated Large Shelf                        | SPE48                         | 403-723C      |
| Epoxy Coated Small Shelf                        | SPE48                         | 403-721C      |
| Epoxy Coated Large Shelf                        | SPE60                         | 403-723C      |
| Epoxy Coated Small Shelf                        | SPE60                         | 403-721C      |
| Epoxy Coated Large Shelf                        | SPE72                         | 403-723C      |
| Epoxy Coated Small Shelf                        | SPE72                         | 403-721C      |
| Bottle Organizer (Holds Qty. 10 Bottles) 16 oz. | SPE Mega Tops                 | 00B23-023D-01 |
| Bottle Organizer (Holds Qty. 10 Bottles) 24 oz. | SPE Mega Tops                 | 00B23-024D-01 |
| Bottle Organizer (Holds Qty. 8 Bottles) 16 oz.  | SPE Standard & Cutting Tops   | 00B23-025D-01 |
| Bottle Organizer (Holds Qty. 6 Bottles) 24 oz.  | SPE Standard & Cutting Tops   | 00B23-026D-01 |
| <b>CRUMBCATCHERS</b>                            |                               |               |
| Crumbcatcher Kit                                | SPE27A/SPE27B/SPE27MA/SPE27MB | 00C23-071A-01 |
| Crumbcatcher Kit                                | SPE36/36M                     | 00C23-071A-09 |
| Crumbcatcher Kit                                | SPE48/48M                     | 00C23-071A-02 |
| Crumbcatcher Kit                                | SPE60/60M                     | 00C23-071A-03 |
| Crumbcatcher Kit                                | SPE72/72M                     | 00C23-071A-04 |
| Crumbcatcher Kit                                | SPE27C                        | 00C23-071A-05 |
| Crumbcatcher Kit                                | SPE36C                        | 00C23-071A-10 |
| Crumbcatcher Kit                                | SPE48C                        | 00C23-071A-06 |
| Crumbcatcher Kit                                | SPE60C                        | 00C23-071A-07 |
| Crumbcatcher Kit                                | SPE72C                        | 00C23-071A-08 |
| Side Crumbcatcher Kit                           | SPE Series                    | 00C23-072A    |
| <b>TRAY SLIDES &amp; PAN INSERTS</b>            |                               |               |
| Tray Slide                                      | SPE60                         | 403-963D      |
| Tray Slide                                      | SPE72                         | 403-968D      |
| Pan Insert                                      | SPE27A                        | 00B23-032D-01 |
| Pan Insert                                      | SPE27B                        | 00B32-033D-01 |

| SPE WHITE POLY CUTTING BOARDS |                         |             |
|-------------------------------|-------------------------|-------------|
| 10" Cutting Board             | SPE27/27-12M, SPED27    | 705-290C-01 |
| 10" Cutting Board             | SPE36/SPE36 MEGA/SPED36 | 705-290C-05 |
| 10" Cutting Board             | SPE48/48M, SPED48       | 705-290C-02 |
| 10" Cutting Board             | SPE60/60M, SPED60       | 705-290C-03 |
| 10" Cutting Board             | SPE72/72M, SPED72       | 705-290C-04 |
| 17" Cutting Board             | SPE27C, SPED27C         | 705-264C    |
| 17" Cutting Board             | SPE36C/SPED36C          | 705-414D-01 |
| 17" Cutting Board             | SPE48C, SPED48C         | 705-265C    |
| 17" Cutting Board             | SPE60C, SPED60C         | 705-266C    |
| 17" Cutting Board             | SPE72C, SPED72C         | 705-267C    |

| DP WHITE POLY CUTTING BOARDS (1/2" THICK) |       |             |
|---|-------|-------------|
| 19" Cutting Board                         | DP46  | 705-307C-01 |
| 19" Cutting Board                         | DP67  | 705-286B    |
| 19" Cutting Board                         | DP93  | 705-287B    |
| 19" Cutting Board                         | DP119 | 705-288B    |

| SPE COMPOSITE CUTTING BOARDS (1/2" THICK) |        |             |
|---|--------|-------------|
| 10" Composite Cutting Board               | SPE27M | 705-392D-06 |
| 17" Composite Cutting Board               | SPE27C | 705-392D-07 |
| 10" Composite Cutting Board               | SPE36A | 705-392D-15 |
| 17" Composite Cutting Board               | SPE36A | 705-392D-16 |
| 10" Composite Cutting Board               | SPE48  | 705-392D-04 |
| 12" Composite Cutting Board               | SPE48  | 705-378B-01 |
| 15" Composite Cutting Board               | SPE48C | 705-392D-01 |
| 17" Composite Cutting Board               | SPE48C | 705-392D-08 |
| 10" Composite Cutting Board               | SPE60  | 705-392D-05 |
| 15" Composite Cutting Board               | SPE60C | 705-392D-02 |
| 17" Composite Cutting Board               | SPE60C | 705-392D-09 |
| 10" Composite Cutting Board               | SPE72  | 705-378B-02 |
| 17" Composite Cutting Board               | SPE72C | 705-392D-10 |

| DP COMPOSITE CUTTING BOARDS (1/2" THICK) |       |             |
|--|-------|-------------|
| 19" X 46" Composite Cutting Board        | DP46  | 705-392D-11 |
| 19" X 67" Composite Cutting Board        | DP67  | 705-392D-12 |
| 19" X 93" Composite Cutting Board        | DP93  | 705-392D-13 |
| 19" X 119" Composite Cutting Board       | DP119 | 705-392D-14 |

| ADDITIONAL ACCESSORIES |                    |            |
|------------------------|--------------------|------------|
| Door Lock              | DP, SPE (per door) | 00C30-099A |
| Digital Thermometer    | DD, SPE            | 402-249A   |

| MOUNTING                |                               |            |
|-------------------------|-------------------------------|------------|
| 3" Caster               | SPE units (set of four)       | 00C31-041A |
| 6" Caster               | SPE units (set of four)       | 00C31-038A |
| 3" Caster               | DP46,67,93 (set of four)      | 61C01-013A |
| 6" Caster               | DP46,67,93 (set of four)      | 61C01-001A |
| 3" Caster               | DP119 (set of six)            | 61C01-012A |
| 6" Black Leg            | SPE units (set of four)       | 58B02S001A |
| 6" Black Leg            | DP46,67,93 (set of four)      | 58B02S001A |
| 6" Black Leg            | DP119 (set of six)            | 58B02S002A |
| 6" Seismic/Flanged Legs | SPE Series (set of four)      | 00C31-055A |
| 6" Seismic/Flanged Legs | DP Series (set of four)       | 00C31-055A |
| 2 3/4 in Caster Kit     | Low Profile (set of four) SPE | 00C31-049A |
| 2" Roller Kit           | SPE units                     | 00C31S045A |

# Food Prep Table Accessories

| OVERSHELVES             |                 |               |
|-------------------------|-----------------|---------------|
| 10" Single              | SPE27           | 00C23S026A    |
| 10" Single              | SPE36-08        | 00C23-074A-11 |
| 10" Single              | SPE36-10        | 00C23-074A-12 |
| 10" Single              | SPE48           | 00C23-027A    |
| 10" Single              | SPE60           | 00C23-028A    |
| 10" Single              | SPE72           | 00C23-029A    |
| 10" Double              | SPE27           | 00C23-030A    |
| 10" Double              | SPE36-08        | 00C23-075A-08 |
| 10" Double              | SPE36-10        | 00C23-075A-09 |
| 10" Double              | SPE48           | 00C23-031A    |
| 10" Double              | SPE60           | 00C23-032A    |
| 10" Double              | SPE72           | 00C23-033A    |
| Single                  | SPE27-12M       | 00C23-074A-01 |
| Single                  | SPE36-12M       | 00C23-074A-10 |
| Single                  | SPE36-15M       | 00C23-074A-12 |
| Single                  | SPE48/60/72-12M | 00C23-074A-02 |
| Single                  | SPE48-18M       | 00C23-074A-03 |
| Single / For Dual-Sided | SPE48-18M-DS    | 00C23-105D    |
| Single                  | SPE60-18M       | 00C23-074A-04 |
| Single                  | SPE60-24M       | 00C23-074A-05 |
| Single / For Dual-Sided | SPE60-24M-DS    | 00C23-106D    |
| Single                  | SPE72-18M       | 00C23-074A-06 |
| Single                  | SPE72-24M       | 00C23-074A-07 |
| Single                  | SPE72-30M       | 00C23-074A-08 |
| Single / For Dual-Sided | SPE72-30M-DS    | 00C23-093A    |
| Double                  | SPE27-12M       | 00C23-030A    |
| Double                  | SPE27-12M-B     | 00C23-075A-06 |
| Double                  | SPE36-12M       | 00C23-075A-8  |
| Double                  | SPE36-15M       | 00C23-075A-09 |
| Double                  | SPE48-12M       | 00C23-075A-01 |
| Double / For Dual-Sided | SPE48-18M-DS    | 00C23-107D-02 |
| Double                  | SPE60-12M       | 00C23-075A-01 |
| Double                  | SPE72-12M       | 00C23-075A-01 |
| Double                  | SPE48-18M       | 00C23-075A-02 |
| Double                  | SPE60-18M       | 00C23-075A-03 |
| Double                  | SPE60-24M       | 00C23-075A-04 |
| Double / For Dual-Sided | SPE60-24M-DS    | 00C23-107D-03 |
| Double                  | SPE72-24M       | 00C23-032A    |
| Double                  | SPE72-30M       | 00C23-075A-05 |
| Double / For Dual-Sided | SPE72-30M-DS    | 00C23-107D-04 |



| OVERSHELVES CONT'D                             |                                 |               |
|--|---------------------------------|---------------|
| Single - 14" Deep                              | DP46                            | 00C23-044A    |
| Single - 14" Deep                              | DP67                            | 00C23-045A    |
| Single - 14" Deep                              | DP93                            | 00C23-046A    |
| Single - 14" Deep                              | DP119                           | 00C23-047A    |
| Single - 14" Deep                              | DP46                            | 00C23-119D-01 |
| Double - 14" Deep                              | DP67                            | 00C23-116D-01 |
| Double - 14" Deep                              | DP93                            | 00C23-120D-00 |
| Double - 14" Deep                              | DP119                           | 00C23-121D-00 |
| Single - 14" Deep                              | SPE36-15M-STL                   | 00C23-110D    |
| Single - 14" Deep                              | SPE48-18M-STL                   | 00C23-094D    |
| Single - 14" Deep                              | SPE60-24M-STL                   | 00C23-095D    |
| Single - 14" Deep                              | SPE72-30M-STL                   | 00C23-096D    |
| Single - 14" Deep with side guards & LED light | SPE48-18M-STL                   | 00C23-113D-01 |
| Single - 14" Deep with side guards & LED light | SPE60-24M-STL                   | 00C23-113D-02 |
| Single - 14" Deep with side guards & LED light | SPE72-30M-STL                   | 00C23-113D-03 |
| Double - 10" Deep                              | SPE27 (will not work on B top)  | 00C23-123D-00 |
| Double - 10" Deep                              | SPE36                           | 00C23-124D-00 |
| Double - 10" Deep                              | SPE48                           | 00C23-125D-00 |
| Double - 10" Deep                              | SPE60                           | 00C23-126D-00 |
| Double - 10" Deep                              | SPE72                           | 00C23-127D-00 |
| Double - 18" Deep                              | SPE27-M (will not fit on B top) | 00C23-128D-00 |
| Double - 18" Deep                              | SPE36-M                         | 00C23-129D-00 |
| Double - 18" Deep                              | SPE48-M                         | 00C23-130D-00 |
| Double - 18" Deep                              | SPE60-M                         | 00C23-131D-00 |
| Double - 18" Deep                              | SPE72-M                         | 00C23-132D-00 |

| NIGHT COVERS FOR STANDARD PREP | COVERS REQUIRED | DESCRIPTION  | PART NUMBER   |
|--------------------------------|-----------------|--------------|---------------|
| SPE27                          | 1               | 8 pan cover  | 00C32-013A-02 |
| SPE36-08                       | 1               | 8 pan cover  | 00C32-013A-06 |
| SPE36-10                       | 1               | 10 pan cover | 00C32-013A-07 |
| SPE48-08                       | 1               | 8 pan cover  | 00C32-013A-02 |
| SPE48-10                       | 1               | 10 pan cover | 00C32-013A-03 |
| SPE48-12                       | 1               | 12 pan cover | 00C32-013A-04 |
| SPE60-08                       | 1               | 8 pan cover  | 00C32-013A-02 |
| SPE60-10                       | 1               | 10 pan cover | 00C32-013A-03 |
| SPE60-12                       | 1               | 12 pan cover | 00C32-013A-04 |
| SPE60-16                       | 1               | 16 pan cover | 00C32-013A-05 |
| SPE72-08                       | 1               | 8 pan cover  | 00C32-013A-02 |
| SPE72-10                       | 1               | 10 pan cover | 00C32-013A-03 |
| SPE72-12                       | 1               | 12 pan cover | 00C32-013A-04 |
| SPE72-18                       | 2               | 12 pan cover | 00C32-013A-04 |
|                                |                 | 6 pan cover  | 00C32-013A-01 |

| NIGHT COVERS FOR MEGATOP PREP | COVERS REQUIRED | DESCRIPTION              | PART NUMBER   |
|-------------------------------|-----------------|--------------------------|---------------|
| SPE27-12M                     | 1               | 12 pan cover             | 00C32-014A-01 |
| SPE36-12M                     | 1               | 12 pan cover             | 00C32-014A-01 |
| SPE36-15M                     | 1               | 15 pan cover             | 00C32-014A-04 |
| SPE48-12M                     | 1               | 12 pan cover             | 00C32-014A-01 |
| SPE48-18M                     | 1               | 18 pan cover             | 00C32-014A-02 |
| SPE60-12M                     | 1               | 12 pan cover             | 00C32-014A-01 |
| SPE60-18M                     | 1               | 18 pan cover             | 00C32-014A-02 |
| SPE60-24M                     | 2               | 12 pan cover (order two) | 00C32-014A-01 |
| SPE72-12M                     | 1               | 12 pan cover             | 00C32-014A-01 |
| SPE72-18M                     | 1               | 18 pan cover             | 00C32-014A-02 |
| SPE72-24M                     | 2               | 12 pan cover (order two) | 00C32-014A-01 |
| SPE72-30M                     | 2               | 12 pan cover             | 00C32-014A-01 |
|                               |                 | 18 pan cover             | 00C32-014A-02 |





# WORKTOPS & UNDERCOUNTERS

FOUNDATION OF KITCHEN LAYOUTS BUILT TO PERFORM

# WORKTOPS

**Stainless steel top**

**Full electronic control**

**Interior thermometer**

**Self-closing doors**

with 120° stay-open feature, on cartridge style hinges

**Easy door removal**

for service and cleaning

**Magnetic gasket**

attached to each door for positive seal

**Two epoxy-coated steel wire shelves per section**

**Field-reversible doors**

**6" heavy duty casters**

3" casters or 6" leg option available at no charge when specified on order



## DESIGNED TO PERFORM IN HIGH AMBIENT CONDITIONS

## 3 YEAR PARTS & LABOR WARRANTY WITH AN ADDITIONAL 2 YEAR COMPRESSOR WARRANTY

## MADE IN USA



**REMOVABLE BACKSPASH**  
available as an option, as well as a Flat Top, or a Foamed-in-Place backsplash



**FIELD REVERSIBLE DOORS**  
for layout flexibility

### ACCESS OPTIONS

- Doors
- Drawers

### AGENCY CERTIFICATIONS





#### EXTERIOR FINISHES

- Stainless steel with galvanized back
- Stainless steel with stainless back

#### INTERIOR FINISHES

- Corrosion-resistant aluminum
- Stainless

#### AVAILABLE ACCESSORIES

- Overshelf kits
- Composite cutting boards
- Bun tray rack
- Locks (doors only)
- Glass doors
- 16-gauge stainless steel top

#### AVAILABLE OPTIONS

- Left hand hinge doors
- Remote models available

#### BACKSPLASH OPTIONS

- Removable
- 4" foamed-in-place
- Flat-top

#### MOUNTING OPTIONS

- 6" casters
- 3" casters (allows for ADA compliant working height)
- 6" legs

# WORKTOPS

## Rear-Mounted Refrigeration

### REFRIGERATORS - DOORS

MAINTAINS PRODUCT TEMPERATURES OF 36-38°F.

| MODEL WIDTH | MODEL DEPTH | MODEL #      | DOORS/SHELVES | VOLTS | HP  | AMPS | CUBIC FEET | WIDTH | DEPTH | HEIGHT | CRATED WEIGHT | BACK SPLASH |
|-------------|-------------|--------------|---------------|-------|-----|------|------------|-------|-------|--------|---------------|-------------|
| 24"         | Solid       | WTR24AHC     | 1/2           | 115   | 1/6 | 2    | 5.16       | 24    | 32    | 33.63  | 168           | REMOVABLE   |
|             | Solid       | WTR24AHC-FIP | 1/2           | 115   | 1/6 | 2    | 5.16       | 24    | 32    | 33.63  | 182           | FOAM        |
|             | Solid       | WTR24AHC-FLT | 1/2           | 115   | 1/6 | 2    | 5.16       | 24    | 32    | 29.63  | 168           | FLAT TOP    |
| 27"         | Solid       | WTR27AHC     | 1/2           | 115   | 1/6 | 2    | 6.13       | 27    | 32    | 33.63  | 184           | REMOVABLE   |
|             | Solid       | WTR27AHC-FIP | 1/2           | 115   | 1/6 | 2    | 6.13       | 27    | 32    | 33.63  | 172           | FOAM        |
|             | Solid       | WTR27AHC-FLT | 1/2           | 115   | 1/6 | 2    | 6.13       | 27    | 32    | 29.63  | 180           | FLAT TOP    |
| 32"         | Solid       | WTR32AHC     | 1/2/          | 115   | 1/6 | 2    | 7.2        | 32    | 32    | 33.63  | 184           | REMOVABLE   |
|             | Solid       | WTR32AHC-FIP | 1/2/          | 115   | 1/6 | 2    | 7.2        | 32    | 32    | 33.63  | 172           | FOAM        |
|             | Solid       | WTR32AHC-FLT | 1/2/          | 115   | 1/6 | 2    | 7.2        | 32    | 32    | 33.63  | 180           | FLAT TOP    |
| 36"         | Solid       | WTR36AHC     | 2/4           | 115   | 1/6 | 2    | 8.5        | 36    | 32    | 33.63  | 216           | REMOVABLE   |
|             | Solid       | WTR36AHC-FIP | 2/4           | 115   | 1/6 | 2    | 8.5        | 36    | 32    | 33.63  | 226           | FOAM        |
|             | Solid       | WTR36AHC-FLT | 2/4           | 115   | 1/6 | 2    | 8.5        | 36    | 32    | 29.63  | 212           | FLAT TOP    |
| 48"         | Solid       | WTR48AHC     | 2/4           | 115   | 1/6 | 2.2  | 11.82      | 48    | 32    | 33.63  | 258           | REMOVABLE   |
|             | Solid       | WTR48AHC-FIP | 2/4           | 115   | 1/6 | 2.2  | 11.82      | 48    | 32    | 33.63  | 266           | FOAM        |
|             | Solid       | WTR48AHC-FLT | 2/4           | 115   | 1/6 | 2.2  | 11.82      | 48    | 32    | 29.63  | 235           | FLAT TOP    |
| 60"         | Solid       | WTR60AHC     | 2/4           | 115   | 1/5 | 3    | 14.75      | 60    | 32    | 33.63  | 312           | REMOVABLE   |
|             | Solid       | WTR60AHC-FIP | 2/4           | 115   | 1/5 | 3    | 14.75      | 60    | 32    | 33.63  | 322           | FOAM        |
|             | Solid       | WTR60AHC-FLT | 2/4           | 115   | 1/5 | 3    | 14.75      | 60    | 32    | 29.63  | 300           | FLAT TOP    |
| 72"         | Solid       | WTR72AHC     | 3/6           | 115   | 1/5 | 3    | 17.88      | 72    | 32    | 33.63  | 334           | REMOVABLE   |
|             | Solid       | WTR72AHC-FIP | 3/6           | 115   | 1/5 | 3    | 17.88      | 72    | 32    | 33.63  | 362           | FOAM        |
|             | Solid       | WTR72AHC-FLT | 3/6           | 115   | 1/5 | 3    | 17.88      | 72    | 32    | 29.63  | 347           | FLAT TOP    |

Depth measurement includes handles. For total height, add 3 or 6 inches, based on your mounting choice.

| BACKSPLASH OPTIONS |                               |
|--------------------|-------------------------------|
| SUFFIX             | EXTERIOR                      |
| (standard)         | Removable backsplash          |
| FIP                | 4" foamed-in-place backsplash |
| FLT                | Flat-top with no backsplash   |

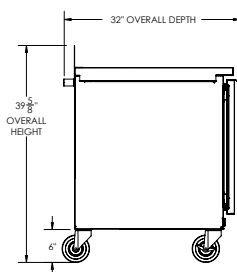

STANDARD

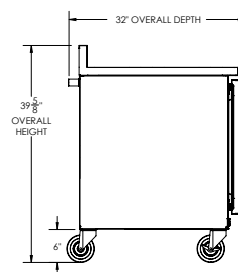

FOAMED IN PLACE

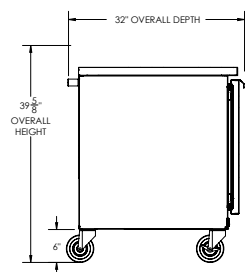

FLAT-TOP

## REFRIGERATORS (SHALLOW DEPTH) - DOORS

MAINTAINS PRODUCT TEMPERATURES OF 36-38°F.

| MODEL WIDTH | DOOR TYPE | MODEL #            | DOORS/<br>SHELVES | VOLTS | HP  | AMPS | CUBIC<br>FEET | WIDTH | DEPTH | HEIGHT | CRATED<br>WEIGHT | BACK<br>SPLASH |
|-------------|-----------|--------------------|-------------------|-------|-----|------|---------------|-------|-------|--------|------------------|----------------|
| <b>20"</b>  | Solid     | <b>WTR20HC</b>     | 1/2               | 115   | 1/6 | 2    | 2.34          | 20    | 24.5  | 30.13  | 116              | REMOVABLE      |
|             | Solid     | <b>WTR20HC-FIP</b> | 1/2               | 115   | 1/6 | 2    | 2.34          | 20    | 24.5  | 30.13  | 124              | FOAM           |
|             | Solid     | <b>WTR20HC-FLT</b> | 1/2               | 115   | 1/6 | 2    | 2.34          | 20    | 24.5  | 30.13  | 119              | FLAT TOP       |
| <b>27"</b>  | Solid     | <b>WTR27HC</b>     | 1/2               | 115   | 1/6 | 2    | 5.25          | 27    | 29.88 | 33.63  | 161              | REMOVABLE      |
|             | Solid     | <b>WTR27HC-FIP</b> | 1/2               | 115   | 1/6 | 2    | 5.25          | 27    | 29.88 | 33.63  | 161              | FOAM           |
|             | Solid     | <b>WTR27HC-FLT</b> | 1/2               | 115   | 1/6 | 2    | 5.25          | 27    | 29.88 | 29.63  | 160              | FLAT TOP       |
| <b>34"</b>  | Solid     | <b>WTR34HC</b>     | 2/4               | 115   | 1/6 | 2    | 3.88          | 34    | 24.63 | 30.13  | 171              | REMOVABLE      |
|             | Solid     | <b>WTR34HC-FIP</b> | 2/4               | 115   | 1/6 | 2    | 3.88          | 34    | 24.63 | 30.13  | 172              | FOAM           |
|             | Solid     | <b>WTR34HC-FLT</b> | 2/4               | 115   | 1/6 | 2    | 3.88          | 34    | 24.63 | 26.13  | 172              | FLAT TOP       |

Depth measurement includes handles. For total height, add 3 or 6 inches, based on your mounting choice.



### AVAILABLE OPTIONS

| SUFFIX                                      | OPTION                  |
|---|-------------------------|
| <b>24</b>                                   | Left hand hinge doors   |
| <b>25</b>                                   | Glass doors             |
| <b>R</b>                                    | Remote models available |
| Append suffix to model # when placing order |                         |

# WORKTOPS

## Rear-Mounted Refrigeration

### REFRIGERATORS - DRAWERS

MAINTAINS PRODUCT TEMPERATURES OF 36-38°F.

| MODEL WIDTH | MODEL #         | DRAWERS | DOORS/SHELVES | VOLTS | HP  | AMPS | CUBIC FEET | WIDTH | DEPTH | HEIGHT | CRATED WEIGHT | BACK SPLASH |
|-------------|-----------------|---------|---------------|-------|-----|------|------------|-------|-------|--------|---------------|-------------|
| 27"         | WTRD27AHC-2     | 2       | -             | 115   | 1/6 | 2    | 6.13       | 27    | 32    | 33.63  | 202           | REMOVABLE   |
|             | WTRD27AHC-2-FIP | 2       | -             | 115   | 1/6 | 2    | 6.13       | 27    | 32    | 33.63  | 202           | FOAM        |
|             | WTRD27AHC-2-FLT | 2       | -             | 115   | 1/6 | 2    | 6.13       | 27    | 32    | 29.63  | 192           | FLAT TOP    |
| 32"         | WTRD32AHC-2     | 2       | -             | 115   | 1/6 | 2    | 7.2        | 32    | 32    | 33.63  | 230           | REMOVABLE   |
|             | WTRD32AHC-2-FIP | 2       | -             | 115   | 1/6 | 2    | 7.2        | 32    | 32    | 33.63  | 244           | FOAM        |
|             | WTRD32AHC-2-FLT | 2       | -             | 115   | 1/6 | 2    | 7.2        | 32    | 32    | 29.63  | 226           | FLAT TOP    |
| 36"         | WTRD36AHC-2     | 2       | -             | 115   | 1/6 | 2    | 8.5        | 36    | 32    | 33.63  | 244           | REMOVABLE   |
|             | WTRD36AHC-2-FIP | 2       | -             | 115   | 1/6 | 2    | 8.5        | 36    | 32    | 33.63  | 258           | FOAM        |
|             | WTRD36AHC-2-FLT | 2       | -             | 115   | 1/6 | 2    | 8.5        | 36    | 32    | 29.63  | 240           | FLAT TOP    |
| 48"         | WTRD48AHC-2     | 2       | 1/2           | 115   | 1/6 | 2.2  | 11.82      | 48    | 32    | 33.63  | 282           | REMOVABLE   |
|             | WTRD48AHC-4     | 4       | -             | 115   | 1/6 | 2.2  | 11.82      | 48    | 32    | 33.63  | 326           | REMOVABLE   |
|             | WTRD48AHC-2-FIP | 2       | 1/2           | 115   | 1/6 | 2.2  | 11.82      | 48    | 32    | 33.63  | 282           | FOAM        |
|             | WTRD48AHC-4-FIP | 4       | -             | 115   | 1/6 | 2.2  | 11.82      | 48    | 32    | 33.63  | 334           | FOAM        |
|             | WTRD48AHC-2-FLT | 2       | 1/2           | 115   | 1/6 | 2.2  | 11.82      | 48    | 32    | 29.63  | 242           | FLAT TOP    |
|             | WTRD48AHC-4-FLT | 4       | -             | 115   | 1/6 | 2.2  | 11.82      | 48    | 32    | 29.63  | 326           | FLAT TOP    |

Depth measurement includes handles.  
For total height, add 3 or 6 inches, based on your mounting choice.

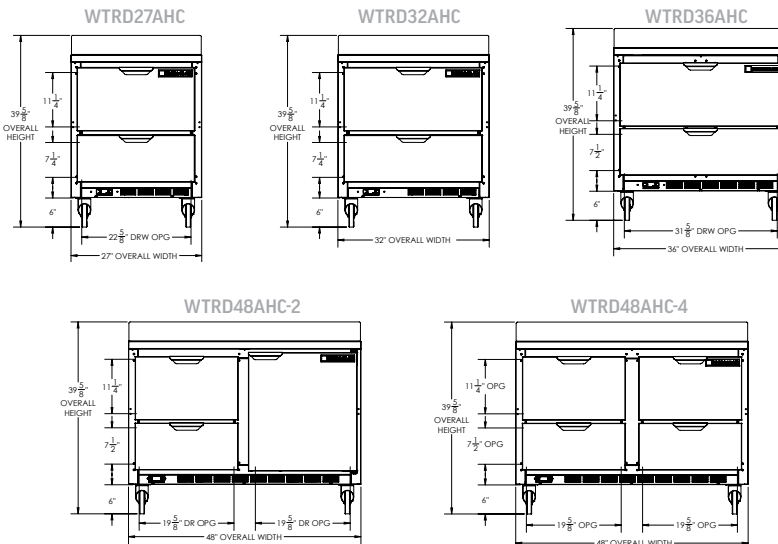



## REFRIGERATORS - DRAWERS

MAINTAINS PRODUCT TEMPERATURES OF 36-38°F.

| MODEL WIDTH | MODEL #         | DRAWERS | DOORS/SHELVES | VOLTS | HP  | AMPS | CUBIC FEET | WIDTH | DEPTH | HEIGHT | CRATED WEIGHT | BACK SPLASH |
|-------------|-----------------|---------|---------------|-------|-----|------|------------|-------|-------|--------|---------------|-------------|
| 60"         | WTRD60AHC-2     | 2       | 1/2           | 115   | 1/5 | 3    | 14.75      | 60    | 32    | 33.63  | 342           | REMOVABLE   |
|             | WTRD60AHC-4     | 4       | –             | 115   | 1/5 | 3    | 14.75      | 60    | 32    | 33.63  | 356           | REMOVABLE   |
|             | WTRD60AHC-2-FIP | 2       | 1/2           | 115   | 1/5 | 3    | 14.75      | 60    | 32    | 33.63  | 342           | FOAM        |
|             | WTRD60AHC-4-FIP | 4       | –             | 115   | 1/5 | 3    | 14.75      | 60    | 32    | 33.63  | 386           | FOAM        |
|             | WTRD60AHC-2-FLT | 2       | 1/2           | 115   | 1/5 | 3    | 14.75      | 60    | 32    | 29.63  | 330           | FLAT TOP    |
|             | WTRD60AHC-4-FLT | 4       | –             | 115   | 1/5 | 3    | 14.75      | 60    | 32    | 29.63  | 271           | FLAT TOP    |
| 72"         | WTRD72AHC-2     | 2       | 2/4           | 115   | 1/5 | 3    | 17.88      | 72    | 32    | 33.63  | 370           | REMOVABLE   |
|             | WTRD72AHC-4     | 4       | 1/2           | 115   | 1/5 | 3    | 17.88      | 72    | 32    | 33.63  | 370           | REMOVABLE   |
|             | WTRD72AHC-6     | 6       | –             | 115   | 1/5 | 3    | 17.88      | 72    | 32    | 33.63  | 330           | REMOVABLE   |
|             | WTRD72AHC-2-FIP | 2       | 2/4           | 115   | 1/5 | 3    | 17.88      | 72    | 32    | 33.63  | 370           | FOAM        |
|             | WTRD72AHC-4-FIP | 4       | 1/2           | 115   | 1/5 | 3    | 17.88      | 72    | 32    | 33.63  | 370           | FOAM        |
|             | WTRD72AHC-6-FIP | 6       | –             | 115   | 1/5 | 3    | 17.88      | 72    | 32    | 33.63  | 370           | FOAM        |
|             | WTRD72AHC-2-FLT | 2       | 2/4           | 115   | 1/5 | 3    | 17.88      | 72    | 32    | 29.63  | 370           | FLAT TOP    |
|             | WTRD72AHC-4-FLT | 4       | 1/2           | 115   | 1/5 | 3    | 17.88      | 72    | 32    | 29.63  | 330           | FLAT TOP    |
|             | WTRD72AHC-6-FLT | 6       | –             | 115   | 1/5 | 3    | 17.88      | 72    | 32    | 29.63  | 422           | FLAT TOP    |

*Depth measurement includes handles.  
For total height, add 3 or 6 inches, based on your mounting choice.*

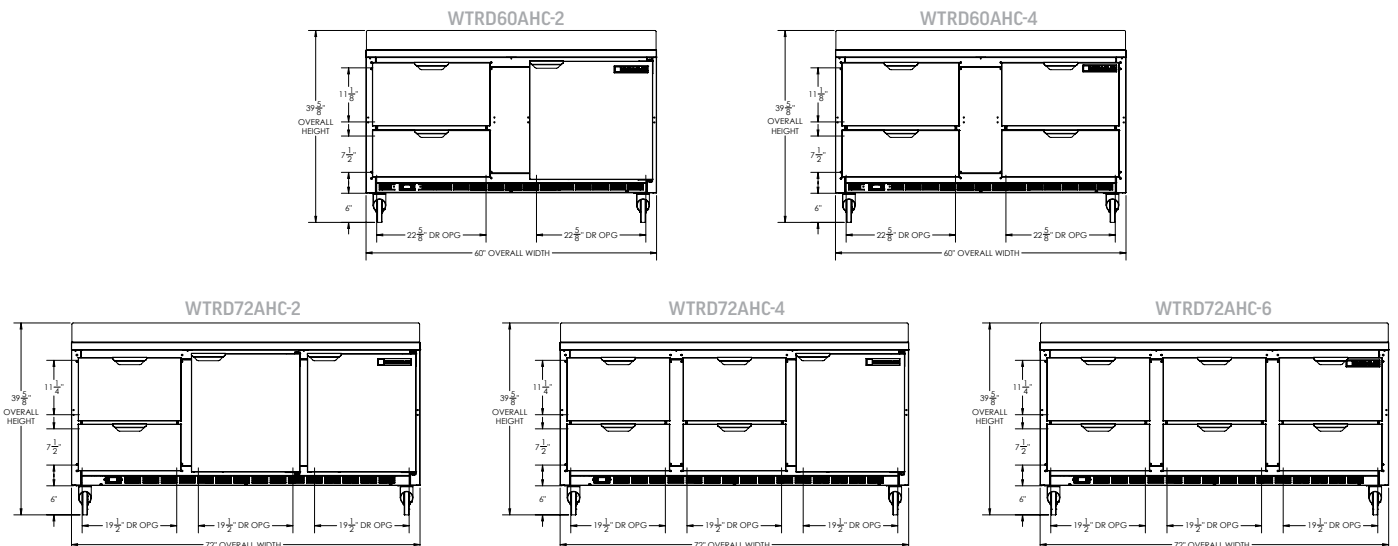

# WORKTOPS

## Rear-Mounted Refrigeration

### FREEZERS - DOORS

MAINTAINS PRODUCT TEMPERATURE AT 0° F AND BELOW.

| MODEL WIDTH | MODEL DEPTH | MODEL #      | DOORS/<br>SHELVES | VOLTS | HP   | AMPS | CUBIC<br>FEET | WIDTH | DEPTH | HEIGHT | CRATED<br>WEIGHT | BACK<br>SPLASH |
|-------------|-------------|--------------|-------------------|-------|------|------|---------------|-------|-------|--------|------------------|----------------|
| 24"         | Solid       | WTF24AHC     | 1/2               | 115   | 1/4  | 2.5  | 5.16          | 24    | 32    | 33.63  | 190              | REMOVABLE      |
|             | Solid       | WTF24AHC-FIP | 1/2               | 115   | 1/4  | 2.5  | 5.16          | 24    | 32    | 33.63  | 184              | FOAM           |
|             | Solid       | WTF24AHC-FLT | 1/2               | 115   | 1/4  | 2.5  | 5.16          | 24    | 32    | 29.63  | 184              | FLAT TOP       |
| 27"         | Solid       | WTF27AHC     | 1/2               | 115   | 1/4  | 2.5  | 6.13          | 27    | 32    | 33.63  | 190              | REMOVABLE      |
|             | Solid       | WTF27AHC-FIP | 1/2               | 115   | 1/4  | 2.5  | 6.13          | 27    | 32    | 33.63  | 202              | FOAM           |
|             | Solid       | WTF27AHC-FLT | 1/2               | 115   | 1/4  | 2.5  | 6.13          | 27    | 32    | 29.63  | 184              | FLAT TOP       |
| 32"         | Solid       | WTF32AHC     | 1/2               | 115   | 1/3+ | 4    | 7.2           | 32    | 32    | 33.63  | 220              | REMOVABLE      |
|             | Solid       | WTF32AHC-FIP | 1/2               | 115   | 1/3+ | 4    | 7.2           | 32    | 32    | 33.63  | 230              | FOAM           |
|             | Solid       | WTF32AHC-FLT | 1/2               | 115   | 1/3+ | 4    | 7.2           | 32    | 32    | 33.63  | 215              | FLAT TOP       |
| 36"         | Solid       | WTF36AHC     | 2/4               | 115   | 1/4  | 6    | 8.69          | 36    | 32    | 33.63  | 232              | REMOVABLE      |
|             | Solid       | WTF36AHC-FIP | 2/4               | 115   | 1/4  | 6    | 8.69          | 36    | 32    | 33.63  | 246              | FOAM           |
|             | Solid       | WTF36AHC-FLT | 2/4               | 115   | 1/2  | 6    | 8.69          | 36    | 32    | 29.63  | 218              | FLAT TOP       |
| 48"         | Solid       | WTF48AHC     | 2/4               | 115   | 1/2  | 7    | 11.04         | 48    | 32    | 33.63  | 294              | REMOVABLE      |
|             | Solid       | WTF48AHC-FIP | 2/4               | 115   | 1/2  | 7    | 11.04         | 48    | 32    | 33.63  | 214              | FOAM           |
|             | Solid       | WTF48AHC-FLT | 2/4               | 115   | 1/2  | 7    | 11.04         | 48    | 32    | 29.63  | 246              | FLAT TOP       |
| 60"         | Solid       | WTF60AHC     | 2/4               | 115   | 1/2  | 7    | 14.39         | 60    | 32    | 33.63  | 320              | REMOVABLE      |
|             | Solid       | WTF60AHC-FIP | 2/4               | 115   | 1/2  | 7    | 14.39         | 60    | 32    | 33.63  | 340              | FOAM           |
|             | Solid       | WTF60AHC-FLT | 2/4               | 115   | 1/2  | 7    | 14.39         | 60    | 32    | 29.63  | 320              | FLAT TOP       |

Depth measurement includes handles.  
For total height, add 3 or 6 inches, based on your mounting choice.

| BACKSPLASH OPTIONS |                               |
|--------------------|-------------------------------|
| SUFFIX             | EXTERIOR                      |
| (standard)         | Removable backsplash          |
| <b>FIP</b>         | 4" foamed-in-place backsplash |
| <b>FLT</b>         | Flat-top with no backsplash   |

| AVAILABLE OPTIONS                              |                         |
|--|-------------------------|
| SUFFIX   | OPTION                  |
| <b>24</b>                                      | Left hand hinge doors   |
| <b>25</b>                                      | Glass doors             |
| <b>R</b>                                       | Remote models available |
| Append suffix to model #<br>when placing order |                         |

## FREEZERS (SHALLOW DEPTH) - DOORS

MAINTAINS PRODUCT TEMPERATURE AT 0° F AND BELOW.

| MODEL WIDTH | DOOR TYPE | MODEL #     | DOORS/<br>SHELVES | VOLTS | HP  | AMPS | CUBIC<br>FEET | WIDTH | DEPTH | HEIGHT | CRATED<br>WEIGHT | BACK<br>SPLASH |
|-------------|-----------|-------------|-------------------|-------|-----|------|---------------|-------|-------|--------|------------------|----------------|
| 20"         | Solid     | WTF20HC     | 1/2               | 115   | 1/4 | 2.5  | 2.34          | 20    | 24.50 | 30.13  | 134              | REMOVABLE      |
|             | Solid     | WTF20HC-FIP | 1/2               | 115   | 1/4 | 2.5  | 2.34          | 20    | 24.50 | 30.13  | 134              | FOAM           |
|             | Solid     | WTF20HC-FLT | 1/2               | 115   | 1/4 | 2.5  | 2.34          | 20    | 24.50 | 26.13  | 134              | FLAT TOP       |
| 27"         | Solid     | WTF27HC     | 1/2               | 115   | 1/4 | 2.5  | 5.25          | 27    | 29.88 | 33.63  | 185              | REMOVABLE      |
|             | Solid     | WTF27HC-FIP | 1/2               | 115   | 1/4 | 2.5  | 5.25          | 27    | 29.88 | 33.63  | 192              | FOAM           |
|             | Solid     | WTF27HC-FLT | 1/2               | 115   | 1/4 | 2.5  | 5.25          | 27    | 29.88 | 29.63  | 185              | FLAT TOP       |

*Depth measurement includes handles.  
For total height, add 3 or 6 inches, based on your mounting choice.*

## DUAL-TEMPS - DOORS

MAINTAINS PRODUCT TEMPERATURES OF  
36-38°F (REFRIGERATOR), AND 0°F (FREEZER).

| MODEL WIDTH | DOOR TYPE | MODEL #        | DOORS/<br>SHELVES | VOLTS | HP               | AMPS             | CUBIC<br>FEET      | WIDTH | DEPTH | HEIGHT | CRATED<br>WEIGHT | BACK<br>SPLASH |
|-------------|-----------|----------------|-------------------|-------|------------------|------------------|--------------------|-------|-------|--------|------------------|----------------|
| 48"         | Solid     | WTRF48A-1-SA-A | 2/4               | 115   | R: 1/4<br>F: 1/2 | R: 4.0<br>F: 5.5 | R: 5.31<br>F: 5.31 | 48    | 32    | 33.63  | 302              | REMOVABLE      |
| 50"         | Solid     | WTRF50A-1-SA-A | 2/4               | 115   | R: 1/4<br>F: 1/2 | R: 4.0<br>F: 5.5 | R: 5.76<br>F: 5.31 | 50    | 32    | 33.63  | 307              | REMOVABLE      |

*Depth measurement includes handles.  
For total height, add 3 or 6 inches, based on your mounting choice.*

# WORKTOPS

## Rear-Mounted Refrigeration

**FREEZERS - DRAWERS - 29**

MAINTAINS PRODUCT TEMPERATURE AT 0° F AND BELOW.

| MODEL WIDTH | MODEL #         | DRAWERS | DOORS/SHELVES | VOLTS | HP   | AMPS | CUBIC FEET | WIDTH | DEPTH | HEIGHT | CRATED WEIGHT | BACK SPLASH |
|-------------|-----------------|---------|---------------|-------|------|------|------------|-------|-------|--------|---------------|-------------|
| 27"         | WTFD27AHC-2     | 2       | -             | 115   | 1/4  | 2.5  | 6.13       | 27    | 32    | 33.63  | 218           | REMOVABLE   |
|             | WTFD27AHC-2-FIP | 2       | -             | 115   | 1/4  | 2.5  | 6.13       | 27    | 32    | 33.63  | 218           | FOAM        |
|             | WTFD27AHC-2-FLT | 2       | -             | 115   | 1/4  | 2.5  | 6.13       | 27    | 32    | 29.63  | 228           | FLAT TOP    |
| 32"         | WTFD32AHC-2     | 2       | -             | 115   | 1/3+ | 4    | 7.2        | 32    | 32    | 33.63  | 248           | REMOVABLE   |
|             | WTFD32AHC-2-FIP | 2       | -             | 115   | 1/3+ | 4    | 7.2        | 32    | 32    | 33.63  | 248           | FOAM        |
|             | WTFD32AHC-2-FLT | 2       | -             | 115   | 1/3+ | 4    | 7.2        | 32    | 32    | 29.63  | 258           | FLAT TOP    |
| 36"         | WTFD36AHC-2     | 2       | -             | 115   | 1/2  | 6    | 8.69       | 36    | 32    | 33.63  | 264           | REMOVABLE   |
|             | WTFD36AHC-2-FIP | 2       | -             | 115   | 1/2  | 6    | 8.69       | 36    | 32    | 33.63  | 262           | FOAM        |
|             | WTFD36AHC-2-FLT | 2       | -             | 115   | 1/2  | 6    | 8.69       | 36    | 32    | 29.63  | 264           | FLAT TOP    |

*Depth measurement includes handles.  
For total height, add 3 or 6 inches, based on your mounting choice.*

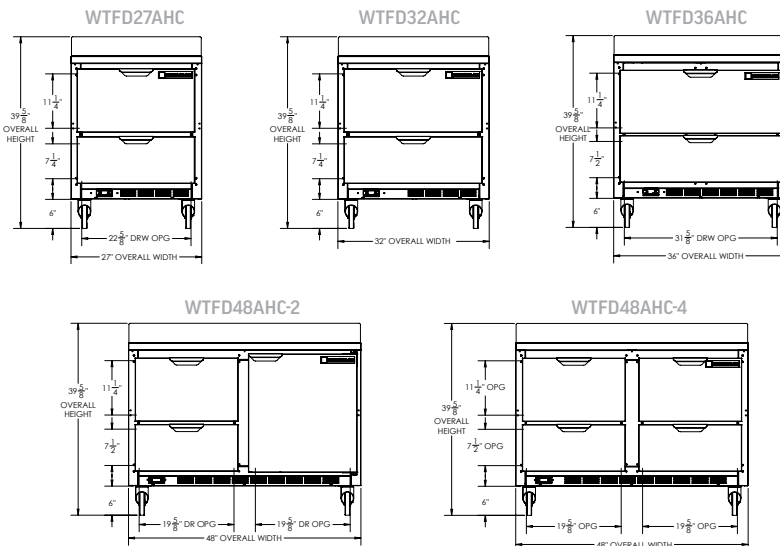

## FREEZERS - DRAWERS - 29

MAINTAINS PRODUCT TEMPERATURE AT 0° F AND BELOW.

| MODEL WIDTH | MODEL #         | DRAWERS | DOORS/SHELVES | VOLTS | HP  | AMPS | CUBIC FEET | WIDTH | DEPTH | HEIGHT | CRATED WEIGHT | BACK SPLASH |
|-------------|-----------------|---------|---------------|-------|-----|------|------------|-------|-------|--------|---------------|-------------|
| 48"         | WTFD48AHC-2     | 2       | 1/2           | 115   | 1/2 | 7    | 11.44      | 48    | 32    | 33.63  | 325           | REMOVABLE   |
|             | WTFD48AHC-4     | 4       | –             | 115   | 1/2 | 7    | 11.44      | 48    | 32    | 33.63  | 356           | REMOVABLE   |
|             | WTFD48AHC-2-FIP | 2       | 1/2           | 115   | 1/2 | 7    | 11.44      | 48    | 32    | 33.63  | 324           | FOAM        |
|             | WTFD48AHC-4-FIP | 4       | –             | 115   | 1/2 | 7    | 11.44      | 48    | 32    | 33.63  | 356           | FOAM        |
|             | WTFD48AHC-2-FLT | 2       | 1/2           | 115   | 1/2 | 7    | 11.44      | 48    | 32    | 29.63  | 310           | FLAT TOP    |
|             | WTFD48AHC-4-FLT | 4       | –             | 115   | 1/2 | 7    | 11.44      | 48    | 32    | 29.63  | 356           | FLAT TOP    |
| 60"         | WTFD60AHC-2     | 2       | 1/2           | 115   | 1/2 | 7    | 14.36      | 60    | 32    | 33.63  | 390           | REMOVABLE   |
|             | WTFD60AHC-4     | 4       | –             | 115   | 1/2 | 7    | 14.36      | 60    | 32    | 33.63  | 392           | REMOVABLE   |
|             | WTFD60AHC-2-FIP | 2       | 1/2           | 115   | 1/2 | 7    | 14.36      | 60    | 32    | 33.63  | 390           | FOAM        |
|             | WTFD60AHC-4-FIP | 4       | –             | 115   | 1/2 | 7    | 14.36      | 60    | 32    | 33.63  | 392           | FOAM        |
|             | WTFD60AHC-2-FLT | 2       | 1/2           | 115   | 1/2 | 7    | 14.36      | 60    | 32    | 29.63  | 390           | FLAT TOP    |
|             | WTFD60AHC-4-FLT | 4       | –             | 115   | 1/2 | 7    | 14.36      | 60    | 32    | 29.63  | 392           | FLAT TOP    |

Depth measurement includes handles.  
For total height, add 3 or 6 inches, based on your mounting choice.

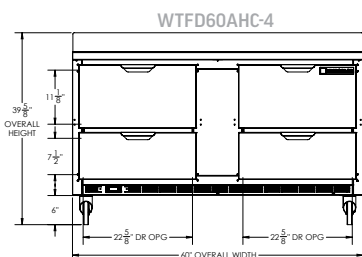
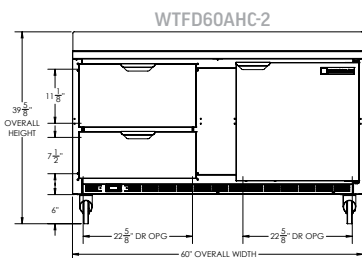

### DRAWER PAN CONFIGURATIONS for WTRD and WTFD units

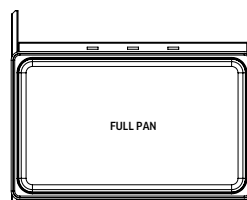

WTRD27 / WTRD32 / WTRD60  
WTFD27 / WTFD32 / WTFD60

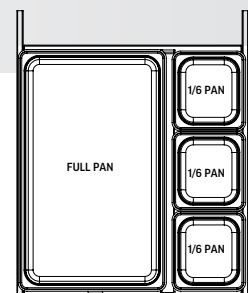

WTRD46 / WTRD67 / WTRD93 / WTRD119  
WTFD46 / WTFD67 / WTFD93 / WTFD119

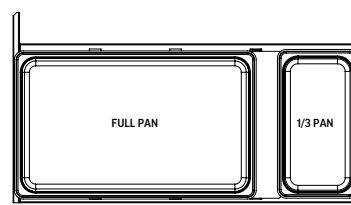

WTRD36 / WTFD36

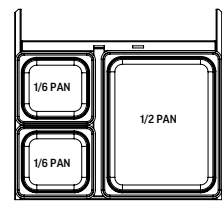

WTRD48 / WTRD72 / WTFD48

# WORKTOPS

## Side-Mounted Refrigeration

### REFRIGERATORS - DOORS

MAINTAINS PRODUCT TEMPERATURES OF 36-38°F.

| MODEL WIDTH | DOOR TYPE | MODEL #          | DOORS/SHELVES | VOLTS | HP  | AMPS | CUBIC FEET | WIDTH | DEPTH | HEIGHT | CRATED WEIGHT | BACK SPLASH |
|-------------|-----------|------------------|---------------|-------|-----|------|------------|-------|-------|--------|---------------|-------------|
| <b>41"</b>  | Solid     | <b>WTR41AHC</b>  | 1/2           | 115   | 1/6 | 2.2  | 7.94       | 41    | 34    | 33.5   | 290           | FOAM        |
| <b>46"</b>  | Solid     | <b>WTR46AHC</b>  | 1/2           | 115   | 1/6 | 3    | 10.8       | 46    | 34    | 33.5   | 325           | FOAM        |
| <b>67"</b>  | Solid     | <b>WTR67AHC</b>  | 2/4           | 115   | 1/5 | 3    | 18.97      | 67    | 34    | 33.5   | 400           | FOAM        |
| <b>93"</b>  | Solid     | <b>WTR93AHC</b>  | 3/6           | 115   | 1/3 | 5    | 29.7       | 93    | 34    | 33.5   | 528           | FOAM        |
| <b>119"</b> | Solid     | <b>WTR119AHC</b> | 4/8           | 115   | 1/3 | 5    | 40.12      | 119   | 34    | 33.5   | 675           | FOAM        |

Depth measurement includes handles.

For total height, add 3 or 6 inches, based on your mounting choice.

| AVAILABLE OPTIONS                           |                         |
|---|-------------------------|
| SUFFIX                                      | OPTION                  |
| <b>24</b>                                   | Left hand hinge doors   |
| <b>25</b>                                   | Glass doors             |
| <b>R</b>                                    | Remote models available |
| Append suffix to model # when placing order |                         |

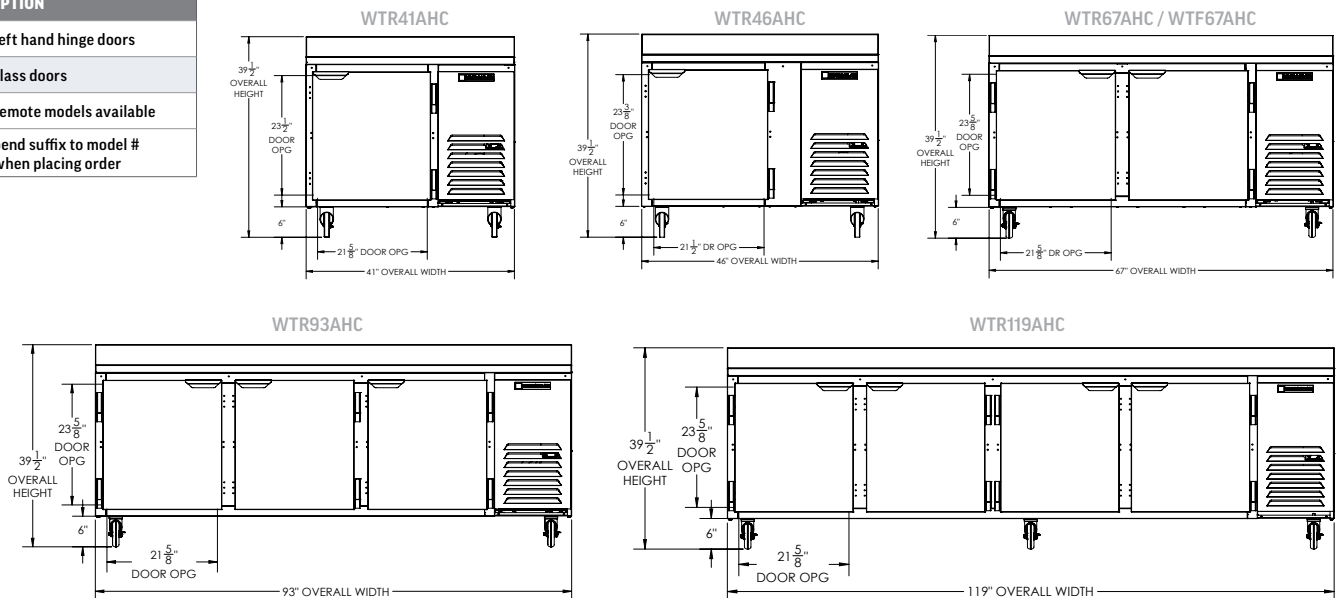

### FREEZERS - DOORS

MAINTAINS PRODUCT TEMPERATURE AT 0° F AND BELOW.

| MODEL WIDTH | DOOR TYPE | MODEL #         | DOORS/SHELVES | VOLTS | HP  | AMPS | CUBIC FEET | WIDTH | DEPTH | HEIGHT | CRATED WEIGHT | BACK SPLASH |
|-------------|-----------|-----------------|---------------|-------|-----|------|------------|-------|-------|--------|---------------|-------------|
| <b>67"</b>  | Solid     | <b>WTF67AHC</b> | 2/4           | 115   | 3/4 | 8.9  | 20.8       | 67    | 34    | 33.50  | 431           | FOAM        |

Depth measurement includes handles.

For total height, add 3 or 6 inches, based on your mounting choice.

## REFRIGERATORS - DRAWERS

MAINTAINS PRODUCT TEMPERATURES OF 36-38°F.

| MODEL WIDTH | MODEL #      | DRAWERS | DOORS/SHELVES | VOLTS | HP  | AMPS | CUBIC FEET | WIDTH | DEPTH | HEIGHT | CRATED WEIGHT | BACK SPLASH |
|-------------|--------------|---------|---------------|-------|-----|------|------------|-------|-------|--------|---------------|-------------|
| <b>46"</b>  | WTRD46AHC-2  | 2       | –             | 115   | 1/5 | 3    | 10.8       | 46    | 34    | 33.38  | 282           | FOAM        |
|             | WTRD67AHC-2  | 2       | 1/2           | 115   | 1/5 | 3    | 18.97      | 67    | 34    | 33.38  | 435           | FOAM        |
| <b>67"</b>  | WTRD67AHC-4  | 4       | –             | 115   | 1/5 | 3    | 18.97      | 67    | 34    | 33.38  | 450           | FOAM        |
|             | WTRD93AHC-2  | 2       | 2/4           | 115   | 1/3 | 5    | 29.7       | 93    | 34    | 33.38  | 562           | FOAM        |
| <b>93"</b>  | WTRD93AHC-4  | 4       | 1/2           | 115   | 1/3 | 5    | 29.7       | 93    | 34    | 33.38  | 588           | FOAM        |
|             | WTRD93AHC-6  | 6       | –             | 115   | 1/3 | 5    | 29.7       | 93    | 34    | 33.38  | 606           | FOAM        |
| <b>119"</b> | WTRD119AHC-2 | 2       | 3/6           | 115   | 1/3 | 4.9  | 40.12      | 119   | 34    | 33.38  | 604           | FOAM        |
|             | WTRD119AHC-4 | 4       | 2/4           | 115   | 1/3 | 4.9  | 40.12      | 119   | 34    | 33.38  | 604           | FOAM        |
|             | WTRD119AHC-6 | 6       | 1/2           | 115   | 1/3 | 4.9  | 40.12      | 119   | 34    | 33.38  | 604           | FOAM        |
|             | WTRD119AHC-8 | 8       | –             | 115   | 1/3 | 4.9  | 40.12      | 119   | 34    | 33.38  | 604           | FOAM        |

*Depth measurement includes handles.  
For total height, add 3 or 6 inches, based on your mounting choice.*



# UNDERCOUNTERS

**Undercounter units feature a 1/2" thick sub-top**

**Full electronic control**

**Interior thermometer**

**Self-closing doors**

with 120° stay-open feature, on cartridge style hinges

**Easy door removal for service and cleaning**

**Magnetic gasket attached to each door**

for positive seal

**6" heavy duty casters standard**

3" casters or 6" leg option available  
at no charge when specified on order

**Two epoxy-coated steel wire shelves**

per section

**Field-reversible doors**



**DESIGNED TO PERFORM IN HIGH AMBIENT CONDITIONS**

**3 YEAR PARTS & LABOR WARRANTY WITH  
AN ADDITIONAL 2 YEAR COMPRESSOR WARRANTY**

**MADE IN USA**



**3" CASTERS AVAILABLE**  
at no charge when specified at the  
time of order



**FIELD REVERSIBLE DOORS**  
for layout flexibility

## ACCESS OPTIONS

- Doors
- Drawers

## AGENCY CERTIFICATIONS







### EXTERIOR FINISHES

- Stainless steel with galvanized back
- Stainless steel with stainless back

### INTERIOR FINISHES

- Corrosion-resistant aluminum
- Stainless

### AVAILABLE ACCESSORIES

- Bun tray rack
- Locks (doors only)
- Glass doors



### AVAILABLE OPTIONS

- Left hand hinge doors
- Remote models available

### MOUNTING OPTIONS

- 6" casters
- 3" casters (allows for ADA compliant working height)
- 6" legs

# UNDERCOUNTERS

## Rear-Mounted Refrigeration

### REFRIGERATORS (SHALLOW DEPTH) - DOORS

MAINTAINS PRODUCT TEMPERATURES OF 36-38°F.

| MODEL WIDTH | DOOR TYPE | MODEL # | DOORS/SHELVES | VOLTS | HP  | AMPS | CUBIC FEET | WIDTH | DEPTH | HEIGHT | CRATED WEIGHT |
|-------------|-----------|---------|---------------|-------|-----|------|------------|-------|-------|--------|---------------|
| 20"         | Solid     | UCR20HC | 1/2           | 115   | 1/6 | 2    | 2.34       | 20    | 24.5  | 25.13  | 119           |
| 27"         | Solid     | UCR27HC | 1/2           | 115   | 1/6 | 2    | 5.25       | 27    | 29.88 | 28.63  | 157           |
| 34"         | Solid     | UCR34HC | 2/2           | 115   | 1/6 | 2    | 3.88       | 34    | 24.63 | 25.13  | 167           |

Depth measurement includes handles. For total height, add 3 or 6 inches, based on your mounting choice.

### REFRIGERATORS - DOORS

MAINTAINS PRODUCT TEMPERATURES OF 36-38°F.

| MODEL WIDTH | DOOR TYPE | MODEL #  | DOORS/SHELVES | VOLTS | HP  | AMPS | CUBIC FEET | WIDTH | DEPTH | HEIGHT | CRATED WEIGHT |
|-------------|-----------|----------|---------------|-------|-----|------|------------|-------|-------|--------|---------------|
| 24"         | Solid     | UCR24AHC | 1/2           | 115   | 1/6 | 2    | 4.48       | 24    | 32    | 28.63  | 164           |
| 27"         | Solid     | UCR27AHC | 1/2           | 115   | 1/6 | 2    | 6.13       | 27    | 32    | 28.63  | 164           |
| 32"         | Solid     | UCR32AHC | 1/2           | 115   | 1/6 | 2    | 7.2        | 32    | 32    | 28.63  | 190           |
| 36"         | Solid     | UCR36AHC | 2/4           | 115   | 1/6 | 2    | 8.5        | 36    | 32    | 28.63  | 204           |
| 48"         | Solid     | UCR48AHC | 2/4           | 115   | 1/6 | 2    | 11.82      | 48    | 32    | 28.63  | 252           |
| 60"         | Solid     | UCR60AHC | 2/4           | 115   | 1/5 | 3    | 14.75      | 60    | 32    | 28.63  | 290           |
| 72"         | Solid     | UCR72AHC | 3/6           | 115   | 1/5 | 3    | 17.88      | 72    | 32    | 28.63  | 336           |

Depth measurement includes handles. For total height, add 3 or 6 inches, based on your mounting choice.

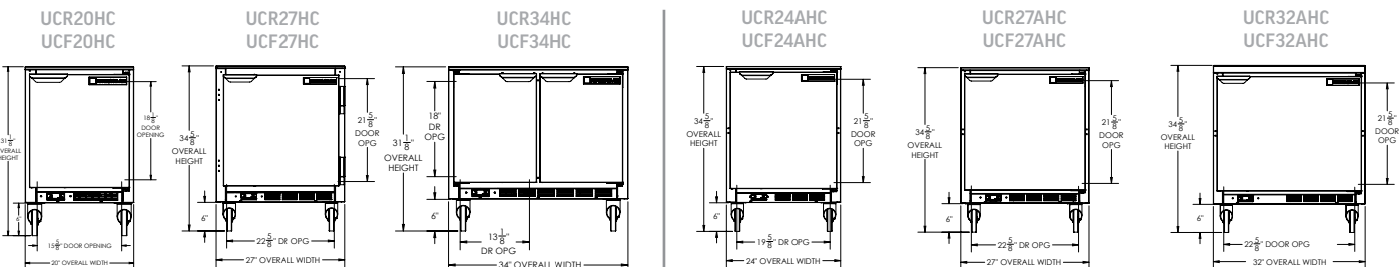

## FREEZERS (SHALLOW DEPTH) - DOORS

MAINTAINS PRODUCT TEMPERATURE AT 0° F AND BELOW.

| MODEL WIDTH | DOOR TYPE | MODEL #        | DOORS/SHELVES | VOLTS | HP  | AMPS | CUBIC FEET | WIDTH | DEPTH | HEIGHT | CRATED WEIGHT |
|-------------|-----------|----------------|---------------|-------|-----|------|------------|-------|-------|--------|---------------|
| <b>20"</b>  | Solid     | <b>UCF20HC</b> | 1/2           | 115   | 1/4 | 2.5  | 2.34       | 20    | 24.5  | 25.13  | 130           |
| <b>24"</b>  | Solid     | <b>UCF24HC</b> | 1/2           | 115   | 1/4 | 2.5  | 4.48       | 24    | 29.88 | 28.63  | 182           |
| <b>27"</b>  | Solid     | <b>UCF27HC</b> | 1/2           | 115   | 1/4 | 2.5  | 5.25       | 27    | 29.88 | 28.63  | 180           |

Depth measurement includes handles. For total height, add 3 or 6 inches, based on your mounting choice.

## FREEZERS - DOORS

MAINTAINS PRODUCT TEMPERATURE AT 0° F AND BELOW.

| MODEL WIDTH | DOOR TYPE | MODEL #         | DOORS/SHELVES | VOLTS | HP   | AMPS | CUBIC FEET | WIDTH | DEPTH | HEIGHT | CRATED WEIGHT |
|-------------|-----------|-----------------|---------------|-------|------|------|------------|-------|-------|--------|---------------|
| <b>24"</b>  | Solid     | <b>UCF24AHC</b> | 1/2           | 115   | 1/4  | 2.5  | 5.16       | 24    | 32    | 28.63  | 182           |
| <b>27"</b>  | Solid     | <b>UCF27AHC</b> | 1/2           | 115   | 1/4  | 2.5  | 6.13       | 27    | 32    | 28.63  | 178           |
| <b>32"</b>  | Solid     | <b>UCF32AHC</b> | 1/2           | 115   | 1/3+ | 4    | 7.2        | 32    | 32    | 28.63  | 206           |
| <b>36"</b>  | Solid     | <b>UCF36AHC</b> | 2/4           | 115   | 1/2  | 6    | 8.69       | 36    | 32    | 28.63  | 218           |
| <b>48"</b>  | Solid     | <b>UCF48AHC</b> | 2/4           | 115   | 1/2  | 7    | 11.04      | 48    | 32    | 28.63  | 272           |
| <b>60"</b>  | Solid     | <b>UCF60AHC</b> | 2/4           | 115   | 1/2  | 7    | 14.39      | 60    | 32    | 28.63  | 330           |

Depth measurement includes handles. For total height, add 3 or 6 inches, based on your mounting choice.

### AVAILABLE OPTIONS

| SUFFIX                                      | OPTION                  |
|---|-------------------------|
| <b>24</b>                                   | Left hand hinge doors   |
| <b>25</b>                                   | Glass doors             |
| <b>R</b>                                    | Remote models available |
| Append suffix to model # when placing order |                         |

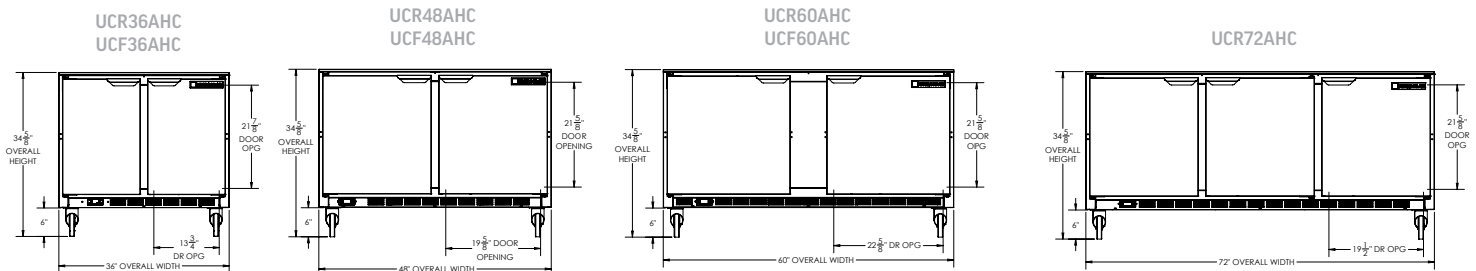

# UNDERCOUNTERS

## Rear-Mounted Refrigeration

### REFRIGERATORS - DRAWERS

MAINTAINS PRODUCT TEMPERATURES OF 36-38°F.

| MODEL WIDTH | MODEL #     | DRAWERS | DOORS/SHELVES | VOLTS | HP  | AMPS | CUBIC FEET | WIDTH | DEPTH | HEIGHT | CRATED WEIGHT |
|-------------|-------------|---------|---------------|-------|-----|------|------------|-------|-------|--------|---------------|
| <b>27"</b>  | UCRD27AHC-2 | 2       | -             | 115   | 1/6 | 2    | 6.13       | 27    | 32    | 28.63  | 196           |
| <b>32"</b>  | UCRD32AHC-2 | 2       | -             | 115   | 1/6 | 2    | 7.2        | 32    | 32    | 28.63  | 222           |
| <b>36"</b>  | UCRD36AHC-2 | 2       | -             | 115   | 1/6 | 2    | 8.5        | 36    | 32.25 | 28.63  | 240           |
| <b>48"</b>  | UCRD48AHC-2 | 2       | 1/2           | 115   | 1/6 | 2.2  | 11.6       | 48    | 32    | 28.5   | 259           |
|             | UCRD48AHC-4 | 4       | -             | 115   | 1/6 | 2.2  | 11.6       | 48    | 31.88 | 28.63  | 306           |
| <b>60"</b>  | UCRD60AHC-2 | 2       | 1/2           | 115   | 1/5 | 3    | 14.4       | 60    | 32    | 28.5   | 235           |
|             | UCRD60AHC-4 | 4       | -             | 115   | 1/5 | 3    | 14.4       | 60    | 32    | 28.5   | 235           |
| <b>72"</b>  | UCRD72AHC-2 | 2       | 2/4           | 115   | 1/5 | 3    | 17.1       | 72    | 32    | 28.5   | 372           |
|             | UCRD72AHC-4 | 4       | 1/2           | 115   |     |      |            | 72    | 32    | 28.5   | 372           |
|             | UCRD72AHC-6 | 6       | -             | 115   |     |      |            | 72    | 29.25 | 28.5   | 372           |

*Depth measurement includes handles.  
For total height, add 3 or 6 inches, based on your mounting choice.*

### FREEZERS - DRAWERS

MAINTAINS PRODUCT TEMPERATURE AT 0° F AND BELOW.

| MODEL WIDTH | MODEL #     | DRAWERS | DOORS/SHELVES | VOLTS | HP   | AMPS | CUBIC FEET | WIDTH | DEPTH | HEIGHT | CRATED WEIGHT |
|-------------|-------------|---------|---------------|-------|------|------|------------|-------|-------|--------|---------------|
| <b>27"</b>  | UCFD27AHC-2 | 2       | -             | 115   | 1/4  | 2.5  | 6.13       | 27    | 32    | 28.63  | 196           |
| <b>32"</b>  | UCFD32AHC-2 | 2       | -             | 115   | 1/3+ | 4    | 7.2        | 32    | 32    | 28.63  | 230           |
| <b>36"</b>  | UCFD36AHC-2 | 2       | -             | 115   | 1/2  | 6    | 8.7        | 36    | 32.25 | 28.63  | 256           |
| <b>48"</b>  | UCFD48AHC-2 | 2       | 1/2           | 115   | 1/2  | 7    | 11.6       | 48    | 32    | 28.63  | 306           |
|             | UCFD48AHC-4 | 4       | -             | 115   | 1/2  | 7    | 11.6       | 48    | 31.88 | 28.63  | 306           |
| <b>60"</b>  | UCFD60AHC-2 | 2       | 1/2           | 115   | 1/2  | 7    | 15.8       | 60    | 32    | 28.63  | 382           |
|             | UCFD60AHC-4 | 4       | -             | 115   | 1/2  | 7    | 15.8       | 60    | 32    | 28.63  | 382           |

*Depth measurement includes handles.  
For total height, add 3 or 6 inches, based on your mounting choice.*

## DUAL-TEMPS - DOORS

MAINTAINS PRODUCT TEMPERATURES OF  
36-38°F (REFRIGERATOR), AND 0°F (FREEZER).

| MODEL WIDTH | DOOR TYPE | MODEL #               | DOORS/<br>SHELVES | VOLTS | HP             | AMPS           | CUBIC<br>FEET      | WIDTH | DEPTH | HEIGHT | CRATED<br>WEIGHT |
|-------------|-----------|-----------------------|-------------------|-------|----------------|----------------|--------------------|-------|-------|--------|------------------|
| <b>48"</b>  | Solid     | <b>UCRF48A-1-SA-A</b> | 2/4               | 115   | R:1/4<br>F:1/2 | R:4.0<br>F:5.5 | R: 5.5<br>F: 5.5   | 48    | 32    | 28.50  | 297              |
|             | Solid     | <b>UCRF48A-1-SA-B</b> | 2/4               | 115   | R:1/4<br>F:1/2 | R:4.0<br>F:5.5 | R: 5.31<br>F: 5.31 | 48    | 32    | 28.50  | 297              |
| <b>50"</b>  | Solid     | <b>UCRF50A-1-SA-A</b> | 2/4               | 115   | R:1/4<br>F:1/2 | R:4.0<br>F:5.5 | R: 5.76<br>F: 5.31 | 50    | 32    | 28.63  | 298              |
|             | Solid     | <b>UCRF50A-1-SA-B</b> | 2/4               | 115   | R:1/4<br>F:1/2 | R:4.0<br>F:5.5 | R: 5.76<br>F: 5.31 | 50    | 32    | 28.63  | 298              |

*Depth measurement includes handles.  
For total height, add 3 or 6 inches, based on your mounting choice.*

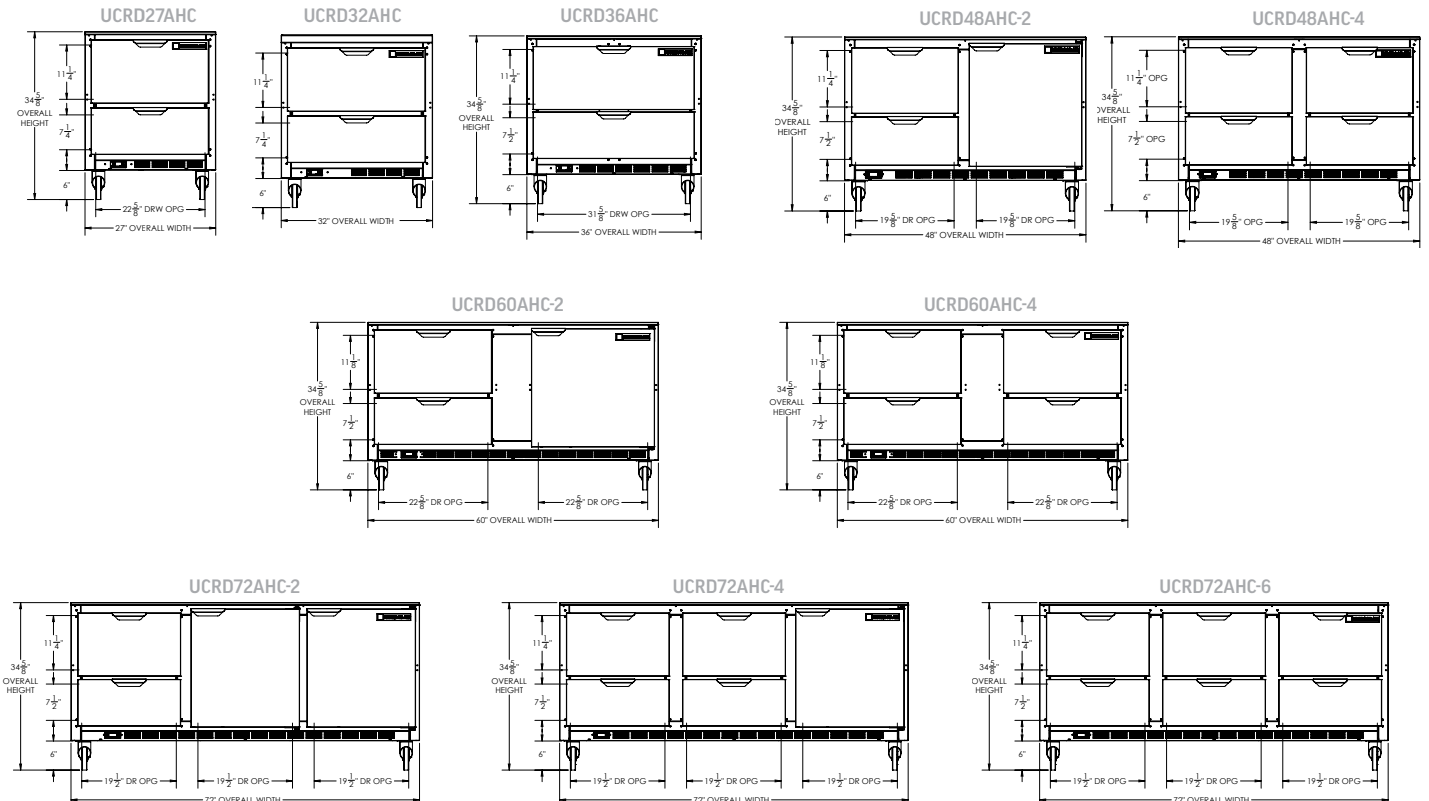

# UNDERCOUNTERS

## Side-Mounted Refrigeration

### REFRIGERATORS - DOORS

MAINTAINS PRODUCT TEMPERATURES OF 36-38°F.

| MODEL WIDTH | DOOR TYPE | MODEL #          | DOORS/SHELVES | VOLTS | HP  | AMPS | CUBIC FEET | WIDTH | DEPTH | HEIGHT | CRATED WEIGHT |
|-------------|-----------|------------------|---------------|-------|-----|------|------------|-------|-------|--------|---------------|
| <b>41"</b>  | Solid     | <b>UCR41AHC</b>  | 1/2           | 115   | 1/5 | 2.2  | 7.94       | 41    | 32.88 | 28.5   | 261           |
| <b>46"</b>  | Solid     | <b>UCR46AHC</b>  | 1/2           | 115   | 1/5 | 3    | 10.8       | 46    | 32.88 | 28.5   | 281           |
| <b>67"</b>  | Solid     | <b>UCR67AHC</b>  | 2/4           | 115   | 1/5 | 2.2  | 18.97      | 67    | 32.88 | 28.5   | 358           |
| <b>93"</b>  | Solid     | <b>UCR93AHC</b>  | 3/6           | 115   | 1/3 | 5    | 29.7       | 93    | 32.88 | 28.5   | 468           |
| <b>119"</b> | Solid     | <b>UCR119AHC</b> | 4/8           | 115   | 1/3 | 5    | 40.12      | 119   | 32.88 | 28.5   | 590           |

Depth measurement includes handles. For total height, add 3 or 6 inches, based on your mounting choice.

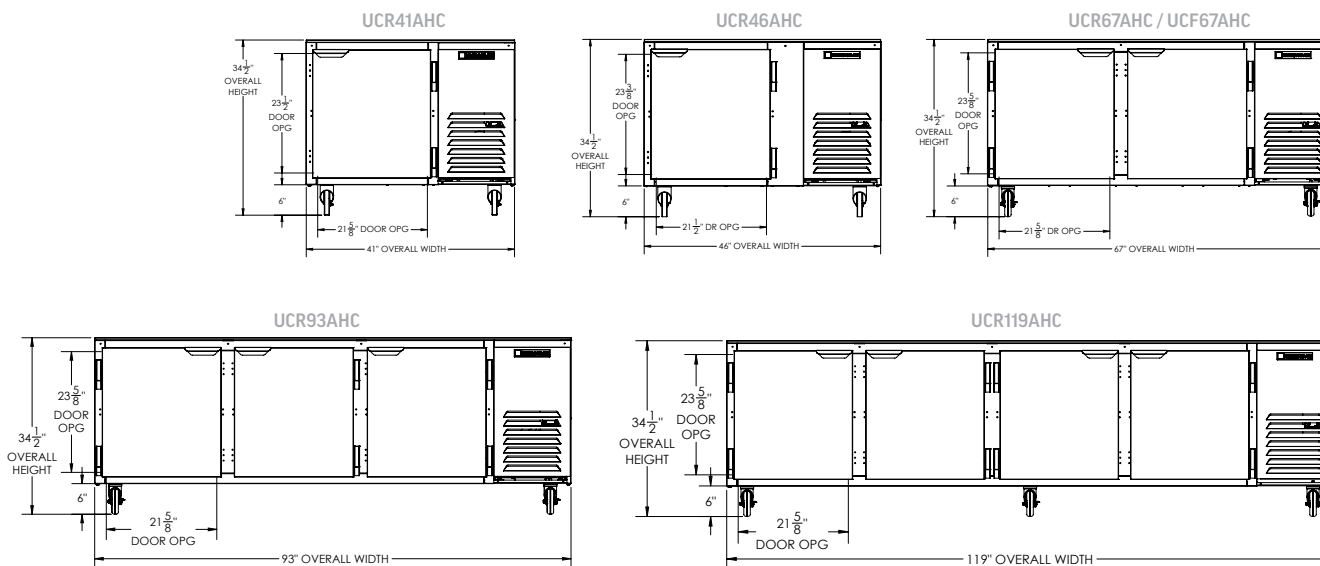

### FREEZERS - DOORS

MAINTAINS PRODUCT TEMPERATURE AT 0° F AND BELOW.

| MODEL WIDTH | DOOR TYPE | MODEL #         | DOORS/SHELVES | VOLTS | HP  | AMPS | CUBIC FEET | WIDTH | DEPTH | HEIGHT | CRATED WEIGHT |
|-------------|-----------|-----------------|---------------|-------|-----|------|------------|-------|-------|--------|---------------|
| <b>67"</b>  | Solid     | <b>UCF67AHC</b> | 2/4           | 115   | 3/4 | 9    | 20.08      | 67    | 32.88 | 28.5   | 266           |

Depth measurement includes handles. For total height, add 3 or 6 inches, based on your mounting choice.

## REFRIGERATORS - DRAWERS

MAINTAINS PRODUCT TEMPERATURES OF 36-38°F.

| MODEL WIDTH | MODEL #      | DRAWERS | DOORS/SHELVES | VOLTS | HP  | AMPS | CUBIC FEET | WIDTH | DEPTH | HEIGHT | CRATED WEIGHT |
|-------------|--------------|---------|---------------|-------|-----|------|------------|-------|-------|--------|---------------|
| <b>46"</b>  | UCRD46AHC-2  | 2       | –             | 115   | 1/5 | 3    | 10.8       | 46    | 32    | 28.5   | 180           |
|             | UCRD67AHC-2  | 2       | 1/2           | 115   | 1/5 | 2.2  | 19.2       | 67    | 32    | 28.5   | 342           |
| <b>67"</b>  | UCRD67AHC-4  | 4       | –             | 115   | 1/5 | 2.2  | 19.2       | 67    | 32    | 28.5   | 342           |
|             | UCRD93AHC-2  | 2       | 2/4           | 115   | 1/5 | 3    | 29.7       | 93    | 32.88 | 28.5   | 496           |
| <b>93"</b>  | UCRD93AHC-4  | 4       | 1/2           | 115   | 1/5 | 3    | 29.7       | 93    | 32    | 28.5   | 520           |
|             | UCRD93AHC-6  | 6       | –             | 115   | 1/5 | 3    | 29.7       | 93    | 32.88 | 28.5   | 565           |
| <b>119"</b> | UCRD119AHC-2 | 2       | 3/6           | 115   | 1/3 | 4.9  | 40.5       | 119   | 32    | 28.5   | 563           |
|             | UCRD119AHC-4 | 4       | 2/4           | 115   | 1/3 | 4.9  | 40.5       | 119   | 32    | 28.5   | 563           |
|             | UCRD119AHC-6 | 6       | 1/2           | 115   | 1/3 | 4.9  | 40.5       | 119   | 32    | 28.5   | 563           |
|             | UCRD119AHC-8 | 8       | –             | 115   | 1/3 | 4.9  | 40.5       | 119   | 32    | 28.5   | 563           |

*Depth measurement includes handles.  
For total height, add 3 or 6 inches, based on your mounting choice.*



# Worktop & Undercounter Accessories

| DESCRIPTION                                 | UNIT(S)   | PART NUMBER   |
|---|---|---------------|
| <b>SHELVING / ORGANIZERS</b>                |   |               |
| Epoxy Coated Wire Shelf (Large)             | UCF/UCR/WTF/WTR27A  | 403-826B      |
| Epoxy Coated Wire Shelf (Small)             | UCF/UCR/WTF/WTR27A  | 403-912D-01   |
| Epoxy Coated Wire Shelf (Large)             | UCF/UCR/WTF/WTR36A  | 403-911D-01   |
| Epoxy Coated Wire Shelf (Small)             | UCF/UCR/WTF/WTR36A  | 403-915D-01   |
| Epoxy Coated Wire Shelf (Large)             | UCF/UCR/WTF/WTR48A  | 403-828B      |
| Epoxy Coated Wire Shelf (Small)             | UCF/UCR/WTF/WTR48A  | 403-913D-01   |
| Epoxy Coated Wire Shelf (Large)             | UCF/UCR/WTF/WTR60A  | 403-829D      |
| Epoxy Coated Wire Shelf (Small)             | UCF/UCR/WTF/WTR60A  | 403-914D-01   |
| Epoxy Coated Ctr Section Wire Shelf (Large) | UCR/WTR72A  | 403-827B      |
| Epoxy Coated Wire Shelf L&R (Large)         | UCR/WTR72A  | 403-828B      |
| Epoxy Coated Ctr Section Wire Shelf (Small) | UCR/WTR72A  | 403-912D-01   |
| Epoxy Coated Wire Shelf L&R (Small)         | UCR/WTR72A  | 403-913D-01   |
| Epoxy Coated Wire Shelf                     | UCR46A/67A, UCF67A  | 403-834D      |
| Epoxy Coated Wire Shelf                     | UCR93A/119A   | 403-834D      |
| Epoxy Coated Wire Shelf                     | WTR41/46/67A/93A  | 403-834D      |
| Epoxy Coated Wire Shelf                     | WTR119A, WTF67A   | 403-834D      |
| Epoxy Coated Wire Shelf                     | UCF/UCR/WTR20   | 403-419D      |
| Epoxy Coated Wire Shelf                     | UCR/WTR34Y  | 403-339D      |
| Epoxy Coated Wire Shelf                     | UCR/UCF/WTF/WTR27 Shallow Depth                           | 403-294D      |
| Shelf Clip                                  | UCR/WTR/UCRD/WTRD   | 403-169A      |
| Epoxy Coated Large Shelf                    | WTR27A/UCR27A   | 403-722C      |
| Epoxy Coated Small Shelf                    | WTR27A/UCR27A   | 403-721C      |
| Epoxy Coated Large Shelf                    | WTR36A, UCR36A  | 403-723C      |
| Epoxy Coated Small Shelf                    | WTR36A, UCR36A  | 403-721C      |
| Epoxy Coated Large Shelf                    | WTR48A/UCR48A   | 403-723C      |
| Epoxy Coated Small Shelf                    | WTR48A/UCR48A   | 403-721C      |
| Epoxy Coated Large Shelf                    | WTR60A/UCR60A   | 403-723C      |
| Epoxy Coated Small Shelf                    | WTR60A/UCR60A   | 403-721C      |
| Epoxy Coated Large Shelf                    | WTR72A/UCR72A   | 403-723C      |
| Epoxy Coated Small Shelf                    | WTR72A/UCR72A   | 403-721C      |
| <b>STACKING COLLARS</b>                     |   |               |
| Stacking Collar                             | UCR20HC, UCF20HC  | 00C32-015A-01 |
| Wall Mount Shelf                            | UCR20HC, UCF20HC (3/16" anchors recommended for mounting) | 00A24-136D-05 |
| Stacking Collar                             | UCR27AHC, UCF27AHC  | 00C32-012A    |



| DESCRIPTION             | UNIT(S)                                | PART NUMBER |
|-------------------------|--|-------------|
| <b>MOUNTING</b>         |  |             |
| 3" Caster               | UCR20,UCF20,UCR27,UCF27,UCR34          | 00C31-041A  |
| 6" Caster               | UCR20,UCF20,UCR27,UCF27,UCR34          | 00C31-038A  |
| 3" Caster               | 29" Undercounter/Worktop (set of four) | 00C31-041A  |
| 6" Caster               | 29" Undercounter/Worktop (set of four) | 00C31-038A  |
| 3" Caster               | 32" Undercounter/Worktop (set of four) | 61C01-013A  |
| 6" Caster               | 32" Undercounter/Worktop (set of four) | 61C01-001A  |
| 3" Caster               | UCR/WTR 119A (set of six)              | 61C01-012A  |
| 6" Black Leg            | 29" Undercounter/Worktop (set of four) | 58B02S001A  |
| 6" Black Leg            | 32" Undercounter/Worktop (set of four) | 58B02S001A  |
| 6" Black Leg            | UCR/WTR 119A (set of six)              | 58B02S002A  |
| 6" Seismic/Flanged Legs | 29" WT/UC (set of four)                | 00C31-055A  |
| 6" Seismic/Flanged Legs | 32" WT/UC (set of four)                | 00C31-055A  |
| 6" Seismic/Flanged Legs | UC Shallow Depth (set of four)         | 00C31-055A  |
| 2 3/4 in Caster Kit     | WT/UC                                  | 00C31-049A  |
| 2" Roller Kit           | WT/UC                                  | 00C31S045A  |

| <b>WORKTOP WHITE POLY CUTTING BOARDS (1/2" THICK)</b> |               |               |
|---|---------------|---------------|
| Set of (2) Brackets Required                          | All Units     | 00C23-076A-01 |
| 29" Cutting Board                                     | WTR27A/WTF27A | 705-397D-05   |
| 29" Cutting Board                                     | WTR36A/WTF36A | 705-397D-19   |
| 29" Cutting Board                                     | WTR48A/WTF48A | 705-397D-06   |
| 29" Cutting Board                                     | WTR60A/WTF60A | 705-397D-07   |

| <b>COMPOSITE CUTTING BOARDS (1/2" THICK)</b> |               |               |
|--|---------------|---------------|
| Set of (2) Brackets Required                 | All Units     | 00C23-076A-01 |
| Composite Cutting Board                      | WTR27A/WTF27A | 705-397D-03   |
| Composite Cutting Board                      | WTR36A/WTF36A | 705-397D-17   |
| Composite Cutting Board                      | WTR41         | 705-397D-18   |
| Composite Cutting Board                      | WTR48A/WTF48A | 705-397D-02   |
| Composite Cutting Board                      | WTR60A/WTF60A | 705-397D-04   |
| Composite Cutting Board                      | WTR72A        | 705-397D-01   |

| <b>ADDITIONAL ACCESSORIES</b> |                    |            |
|-------------------------------|--------------------|------------|
| Door Lock                     | UCR,WTR (per door) | 00C30-099A |
| Digital Thermometer           | WT,UC              | 402-249A   |





# CHEF BASES

AMPLE COLD STORAGE WHILE SUPPORTING WORK SPACES

# CHEF BASES

## Fire-proof 16-gauge stainless steel top

Reinforced with 2" CFC & HCFC-free foam insulation

## No heat shield required

Must adhere to proper clearance per owners manual

## Full marine edge on standard size models

to prevent spills from dripping over the edge

## Full electronic temperature control

## Top & bottom drawers accommodates 6" deep pans

to provide ample food product storage

## Drawers have a dynamic load rating of 275 lbs per drawer

## 12-gauge drawer slides

with 3 Delrin encased stainless steel roller bearings per each drawer slides

## Self-closing drawer feature

engages in the last 1-2" of travel ensuring a perfect seal every time

## 6" heavy duty casters standard

3" casters or 6" leg option available at no charge when specified on order

## Made in the USA



## DESIGNED TO PERFORM IN HIGH AMBIENT CONDITIONS

## 3 YEAR PARTS & LABOR WARRANTY WITH AN ADDITIONAL 2 YEAR COMPRESSOR WARRANTY

## LIFETIME WARRANTY ON ALL DRAWERS AND SLIDES



**12-GAUGE DRAWER SLIDES**  
with 3 Delrin encased stainless steel roller bearings per each drawer slide



**ACCOMMODATES 6" PANS IN**  
top and bottom drawers

### ACCESS OPTIONS

- Drawers

### AGENCY CERTIFICATIONS





### EXTERIOR FINISHES

- Stainless steel with galvanized back

### INTERIOR FINISHES

- Corrosion-resistant aluminum

### AVAILABLE ACCESSORIES

- Custom flat top sizes available, up to 12" overhang on either side to create a custom sized top
- Gasket guards



### AVAILABLE OPTIONS

- Flat Top edge in lieu of marine edge on standard sizes
- Remote models available

### MOUNTING OPTIONS

- 6" casters
- 3" casters (allows for ADA compliant working height)
- 6" legs

# CHEF BASES

## REFRIGERATORS - DRAWERS

MAINTAINS PRODUCT TEMPERATURES OF 36-38°F.

| MODEL WIDTH | MODEL #         | DRAWERS | VOLTS | HP  | AMPS | CUBIC FEET | TOP WIDTH | CABINET WIDTH | DEPTH | HEIGHT | CRATED WEIGHT |
|-------------|-----------------|---------|-------|-----|------|------------|-----------|---------------|-------|--------|---------------|
| 36"         | WTRCS36D-1      | 2       | 115   | 1/4 | 5    | 5.67       | 36        | 36            | 34.75 | 20.63  | 334           |
|             | 48              |         |       |     |      |            | 36        | 34.75         | 20.63 | 346    |               |
| 48"         | WTRCS48D-1      | 2       | 115   | 1/3 | 4.5  | 7.02       | 48        | 48            | 34.75 | 20.63  | 368           |
| 52"         | WTRCS52D-1      | 2       | 115   | 1/3 | 4.5  | 8.99       | 52        | 52            | 34.75 | 20.63  | 380           |
| 60.5"       | WTRCS60D-1      | 2       | 115   | 1/3 | 4.5  | 10.29      | 60.50     | 60.50         | 34.75 | 20.63  | 450           |
|             | 64              |         |       |     |      |            | 60.50     | 34.75         | 20.63 | 458    |               |
| 72"         | WTRCS72D-1      | 4       | 115   | 1/3 | 4.5  | 14.29      | 72        | 72            | 34.75 | 20.63  | 580           |
|             | WTRCS72D-1-76   |         |       |     |      |            | 76        | 72            | 34.75 | 20.63  | 600           |
| 84"         | WTRCS84D-1      | 4       | 115   | 1/3 | 4.5  | 17.37      | 84        | 84            | 34.75 | 20.63  | 636           |
|             | WTRCS84D-1-89   |         |       |     |      |            | 89        | 84            | 34.75 | 20.63  | 648           |
|             | WTRCS84D-1-96   |         |       |     |      |            | 96        | 84            | 34.75 | 20.63  | 680           |
|             | WTRCS84D-1-108  |         |       |     |      |            | 108       | 84            | 34.75 | 20.63  | 680           |
| 112"        | WTRCS112D-1     | 6       | 115   | 1/2 | 7.3  | 22.11      | 112       | 112           | 34.75 | 20.63  | 772           |
|             | WTRCS112D-1-120 |         |       |     |      |            | 120       | 112           | 34.75 | 20.63  | 772           |

Depth measurement includes handles. For total height, add 3 or 6 inches, based on your mounting choice.

## CHEF BASE ACCESSORIES

| DESCRIPTION   | UNIT(S)      | PART NUMBER   |
|---|--------------|---------------|
| <b>MOUNTING</b>   |              |               |
| 3" Caster   | WTRCS Series | 00C26-017A    |
| <b>ADDITIONAL ACCESSORIES</b>                                     |              |               |
| Gasket Guard  | WTRCS36      | 00B23S041D-02 |
| Gasket Guard  | WTRCS60      | 00B23S041D-01 |
| Gasket Guard  | WTRCS72      | 00B23S041D-03 |
| Additional Gasket Guards available for other sizes of Chef Bases. |              |               |

## FREEZERS - DRAWERS

MAINTAINS PRODUCT TEMPERATURE AT 0° F AND BELOW.

| MODEL WIDTH | MODEL #        | DRAWERS | VOLTS | HP  | AMPS | CUBIC FEET | TOP WIDTH | CABINET WIDTH | DEPTH | HEIGHT | CRATED WEIGHT |
|-------------|----------------|---------|-------|-----|------|------------|-----------|---------------|-------|--------|---------------|
| 36"         | WTFCS36D-1     | 2       | 115   | 1/2 | 5    | 5.67       | 36        | 36            | 34.75 | 20.63  | 336           |
|             | 48             |         |       |     |      |            | 36        | 34.75         | 20.63 | 346    |               |
| 52"         | WTFCS52D-1     | 2       | 115   | 3/4 | 10.6 | 8.99       | 52        | 52            | 34.75 | 20.63  | 408           |
| 60.5"       | WTFCS60D-1     | 2       | 115   | 3/4 | 10.6 | 10.29      | 60.50     | 60.50         | 34.75 | 20.63  | 500           |
|             | 64             |         |       |     |      |            | 60.50     | 34.75         | 20.63 | 500    |               |
| 72"         | WTFCS72D-1     | 4       | 115   | 3/4 | 10.6 | 14.29      | 72        | 72            | 34.75 | 20.63  | 594           |
|             | 76             |         |       |     |      |            | 72        | 34.75         | 20.63 | 600    |               |
| 84"         | WTFCS84D-1     | 4       | 115   | 3/4 | 10.6 | 17.37      | 84        | 84            | 34.75 | 20.63  | 636           |
|             | WTFCS84D-1-89  |         |       |     |      |            | 89        | 84            | 34.75 | 20.63  | 636           |
|             | WTFCS84D-1-96  |         |       |     |      |            | 96        | 84            | 34.75 | 20.63  | 678           |
|             | WTFCS84D-1-108 |         |       |     |      |            | 108       | 84            | 34.75 | 20.63  | 678           |

Depth measurement includes handles. For total height, add 3 or 6 inches, based on your mounting choice.



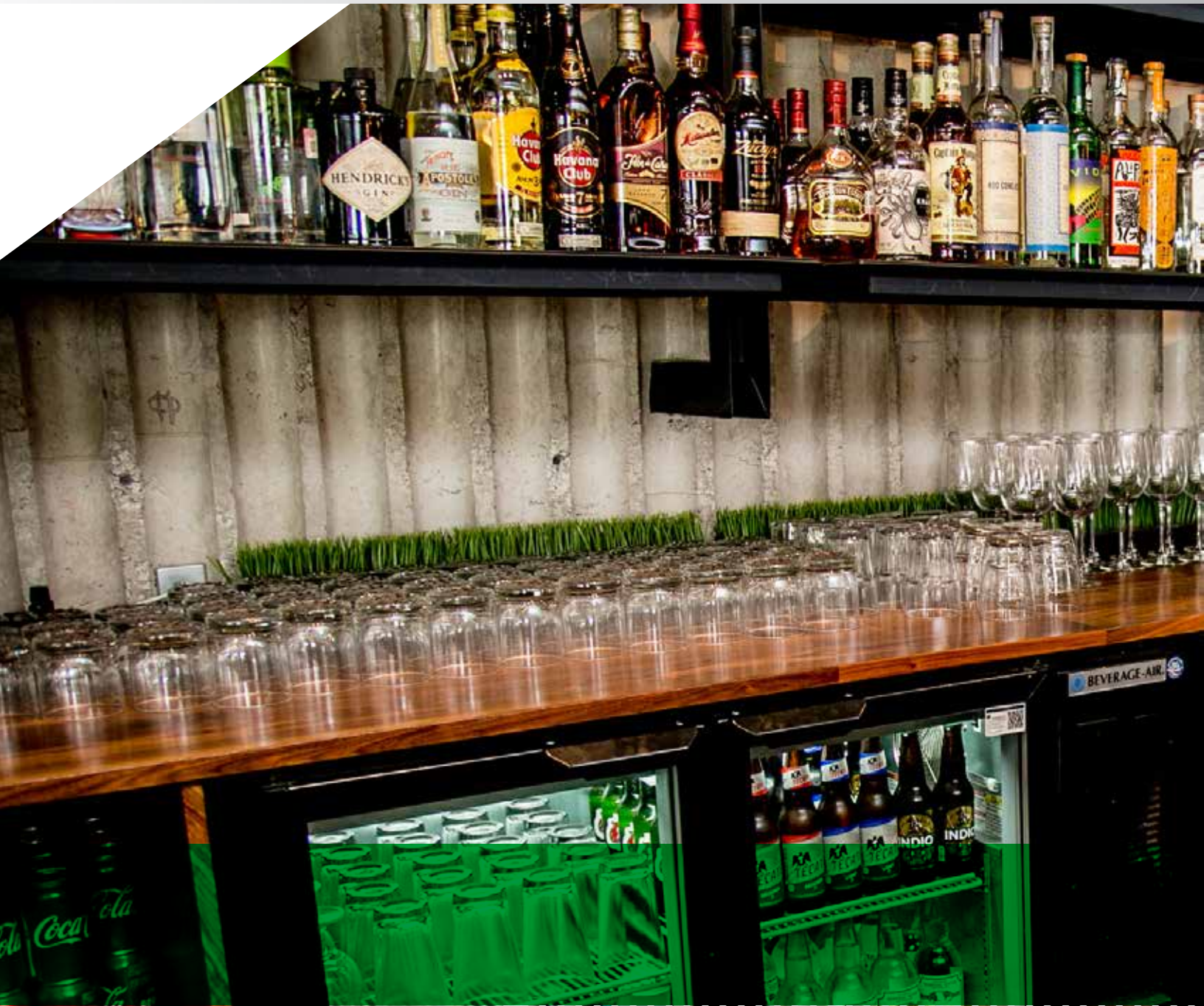





# BAR & WINE EQUIPMENT

DYNAMIC PERFORMANCE THAT ENHANCES THE FRONT OF THE HOUSE

# DIRECT DRAWS

## 3-IN-1 DRAFT SOLUTIONS

Dispense beer, wine, or coffee (other non-alcoholic beverages) with the same tap—no line/manifold changes needed!



**Stainless steel top with drip tray**

**Galvanized steel interior liner**  
with heavy duty stainless steel floor

**Full electronic control**

**Drain tube located at bottom front of cooler**  
connects to floor drain

**Self-closing doors with locks**

**Magnetic gasket attached to each door**  
for positive seal

**Field reversible door**

**Compressor available on left or right side**  
specify at time of order

## WIDE VARIETY OF OPTIONS AND ACCESSORIES

**3 YEAR PARTS & LABOR WARRANTY WITH  
AN ADDITIONAL 2 YEAR COMPRESSOR WARRANTY**

**MADE IN USA**



**LEFT OR RIGHT COMPRESSOR**  
Specify which side the compressor should be located at time of order



**DRAIN TUBE**  
bottom front of cooler (condensor side) and connects directly to floor drain

### ACCESS OPTIONS

- Doors

### AGENCY CERTIFICATIONS



## REFRIGERATORS

MAINTAINS PRODUCT TEMPERATURES OF 36-38°F.

| MODEL WIDTH | MODEL #        | DOORS | VOLTS | HP  | AMPS | CUBIC FEET | WIDTH | DEPTH | HEIGHT | CRATED WEIGHT | # OF STRAIGHT WALL KEGS | FINISH          |
|-------------|----------------|-------|-------|-----|------|------------|-------|-------|--------|---------------|-------------------------|-----------------|
| 24"         | DD24HC-1-B     | 1     | 115   | 1/6 | 2    | 7.66       | 24    | 30.13 | 37.75  | 174           | 1                       | BLACK           |
|             | DD24HC-1-S     |       |       |     |      |            |       |       |        | 184           | 1                       | STAINLESS FRONT |
| 36"         | DD36HC-1-B     | 1     | 115   | 1/4 | 3.2  | 8.31       | 36    | 24.5  | 36     | 250           | 2                       | BLACK           |
|             | DD36HC-1-S     |       |       |     |      |            |       |       |        | 242           | 2                       | STAINLESS       |
| 48"         | DD48HC-1-B     | 2     | 115   | 1/4 | 2.50 | 12.4       | 48    | 24.5  | 36     | 284           | 2                       | BLACK           |
|             | DD48HC-1-S     |       |       |     |      |            |       |       |        |               | 2                       | STAINLESS       |
| 50.5"       | DD50HC-1-B     | 2     | 115   | 1/4 | 2.50 | 17.86      | 50.5  | 29    | 37.25  | 290           | 2                       | BLACK           |
|             | DD50HC-1-S     |       |       |     |      |            |       |       |        | 310           | 2                       | STAINLESS FRONT |
|             | DD50HC-1-C-B   | 2     | 115   | 1/4 | 2.50 | 17.86      | 50.5  | 29    | 37.25  | 310           | 2                       | BLACK           |
|             | DD50HC-1-C-S   |       |       |     |      |            |       |       |        | 310           | 2                       | STAINLESS FRONT |
| 59"         | DD58HC-1-B     | 2     | 115   | 1/4 | 2.50 | 21.86      | 59    | 29    | 37.38  | 342           | 3                       | BLACK           |
|             | DD58HC-1-S     |       |       |     |      |            |       |       |        | 376           | 3                       | STAINLESS FRONT |
|             | DD58HC-1-C-B   | 2     | 115   | 1/4 | 2.50 | 21.86      | 59    | 29    | 37.38  | 342           | 3                       | BLACK           |
|             | DD58HC-1-C-S   |       |       |     |      |            |       |       |        | 342           | 3                       | STAINLESS FRONT |
| 69"         | DD68HC-1-B     | 2     | 115   | 1/3 | 5.5  | 25.93      | 69    | 29    | 37.25  | 380           | 3                       | BLACK           |
|             | DD68HC-1-S     |       |       |     |      |            |       |       |        | 379           | 3                       | STAINLESS FRONT |
|             | DD68HC-1-C-B   | 2     | 115   | 1/3 | 5.5  | 25.93      | 69    | 29    | 37.25  | 400           | 3                       | BLACK           |
|             | DD68HC-1-C-S   |       |       |     |      |            |       |       |        | 400           | 3                       | STAINLESS FRONT |
| 72"         | DD72HC-1-B     | 2     | 115   | 1/3 | 3.1  | 19.95      | 72    | 24.5  | 36     | 424           | 3                       | BLACK           |
|             | DD72HC-1-S     |       |       |     |      |            |       |       |        | 376           | 3                       | STAINLESS       |
| 79"         | DD78HC-1-B     | 3     | 115   | 1/3 | 5.5  | 33.59      | 79    | 29    | 37.38  | 400           | 4                       | BLACK           |
|             | DD78HC-1-S     |       |       |     |      |            |       |       |        | 400           | 4                       | STAINLESS FRONT |
|             | DD78HC-1-B-12T | 3     | 115   | 1/3 | 5.5  | 33.59      | 79    | 29    | 37.38  | 478           | 4                       | BLACK           |
|             | DD78HC-1-S-12T |       |       |     |      |            |       |       |        | 478           | 4                       | STAINLESS FRONT |
| 95"         | DD94HC-1-B     | 3     | 115   | 1/3 | 5.5  | 37.82      | 95    | 29    | 37.38  | 458           | 5                       | BLACK           |
|             | DD94HC-1-S     |       |       |     |      |            |       |       |        | 458           | 5                       | STAINLESS FRONT |
|             | DD94HC-1-B-12T | 3     | 115   | 1/3 | 5.5  | 37.82      | 95    | 29    | 37.38  | 532           | 5                       | BLACK           |
|             | DD94HC-1-S-12T |       |       |     |      |            |       |       |        | 458           | 5                       | STAINLESS FRONT |

Depth measurement includes handles. Height measurement includes mounting height (DD24 only), but excludes tap height. Add average tap height of 15" for total unit height.



### EXTERIOR FINISHES

- Black
- Stainless Steel

### INTERIOR FINISHES

- Galvanized walls with reinforced stainless steel floor

### AVAILABLE ACCESSORIES

- Wine Models
- Wine Taps
- Faucet Locks
- Glass Rinser
- 1-6 Insulated Stainless Towers/Taps
- Optional 12 Tap Tower for 94" Models
- Dual Tap Placement Option
- No Draft Arm with Hole Cover

### AVAILABLE OPTIONS

- Left or right side compressor
- Remote models available

### MOUNTING OPTIONS

- 6" casters
- 3" casters
- 6" legs

# DIRECT DRAWS

## Keg Capacities

BM23 / DD24 / DD36

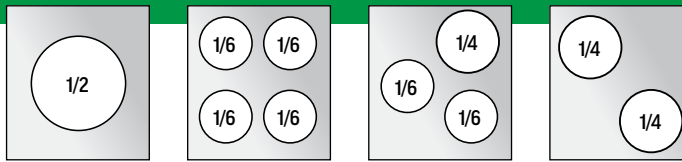

DD48 / DD50

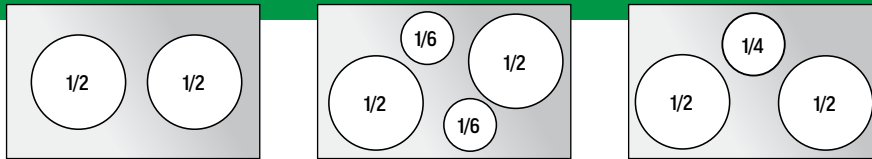

DD58 / DD68 / DD72

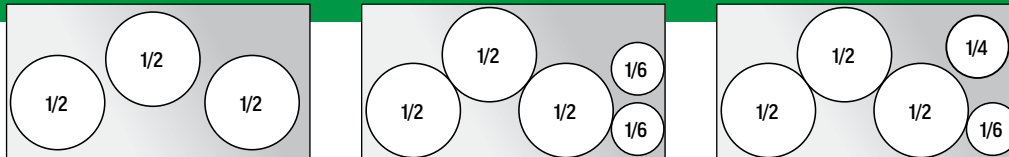

DD78

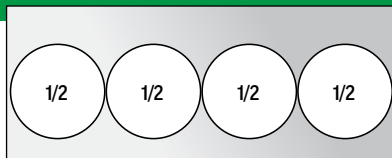

DD94

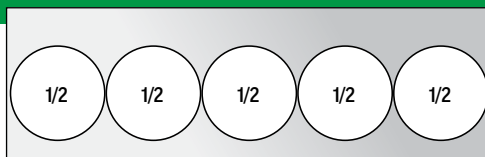

## RC-500 SERIES RAPID CHILL GLASS FROSTER

Freeze any type of glass in a flash

Ideal for chilling beer, champagne, wine,  
and cocktail glasses

Also ideal for chilling the exterior of bottles

Simply push down on the froster head  
to dispense jet of CO2

Neon, color changing lights illuminate the glass as you frost

Does not taint the taste of drinks

RC-500 mounts to any table or bar counter

Sterilizes the glass due to the cooling process, for a more  
hygienic drink service

Will not affect the carbonation or temperature of drinks

No need for electrical connection, for greater portability  
and practicality

LED lights require (2) AA batteries

Requires food grade CO2 cylinders  
with liquid dip tube (siphon tank)

| MODEL # | WIDTH | DEPTH | HEIGHT | CRATED WEIGHT |
|---------|-------|-------|--------|---------------|
| RC-500  | 10.63 | 5.11  | 16.14  | 12            |



# BAR MOBILES

**Stainless steel drip tray for easy cleaning**

**Heavy-duty stainless steel floor**

**Stainless steel top with black glass rails**

**4" casters**

**Full electronic control**

**Interior thermometer**

**Tower has continuous source of cold air**

**Portable unit with waste bottle**

for beer and wine from drain

**Self-closing doors with locks**

**Field-reversible door**

**Magnetic gasket attached to each door**

for positive seal

**Two epoxy-coated steel wire shelves per section**



## WIDE VARIETY OF OPTIONS AND ACCESSORIES

**3 YEAR PARTS & LABOR WARRANTY WITH  
AN ADDITIONAL 2 YEAR COMPRESSOR WARRANTY**

**MADE IN USA**



**PORTABLE WASTE BOTTLE**  
for beer and wine from drain



**STAINLESS STEEL DRIP TRAY**  
for easy cleaning

### ACCESS OPTIONS

- Doors

### AGENCY CERTIFICATIONS



## REFRIGERATORS

MAINTAINS PRODUCT TEMPERATURES OF 36-38°F.

| MODEL WIDTH | MODEL #     | DOORS | VOLTS | HP  | AMPS | CUBIC FEET | WIDTH | DEPTH | HEIGHT | CRATED WEIGHT | # OF STRAIGHT WALL KEGS | FINISH    |
|-------------|-------------|-------|-------|-----|------|------------|-------|-------|--------|---------------|-------------------------|-----------|
| 24"         | BM23HC-B    | 1     | 115   | 1/6 | 2    | 7.66       | 24    | 30.13 | 53     | 176           | 1                       | BLACK     |
|             | BM23HC-B-28 | 1     | 115   | 1/6 | 2    | 7.66       | 24    | 30.13 | 39.37  | 174           | 1                       | BLACK     |
|             | BM23HC-S-31 | 1     | 115   | 1/6 | 2    | 7.66       | 24    | 30.13 | 53     | 180           | 1                       | STAINLESS |
|             | BM23HC-C-B  | 1     | 115   | 1/6 | 2    | 7.66       | 24    | 30.13 | 53.25  | 180           | 1                       | BLACK     |
|             | BM23HC-C-S  | 1     | 115   | 1/6 | 2    | 7.66       | 24    | 30.13 | 53.25  | 186           | 1                       | STAINLESS |

Depth measurement includes handles.

Height measurement includes mounting height and tap height if applicable.

## DUAL ZONE

LEFT COMPARTMENT MAINTAINS 32-40°F.  
RIGHT COMPARTMENT MAINTAINS 50-65°F.

| MODEL WIDTH | MODEL #  | DOORS | VOLTS | HP  | AMPS | CUBIC FEET | WIDTH | DEPTH | HEIGHT | CRATED WEIGHT | # OF STRAIGHT WALL KEGS | FINISH    |
|-------------|----------|-------|-------|-----|------|------------|-------|-------|--------|---------------|-------------------------|-----------|
| 24"         | DZ24-1-B | 1     | 115   | 1/5 | 4    | 7.12       | 24    | 29.38 | 53     | 220           | (4) 1/6                 | BLACK     |
|             | DZ24-1-S |       |       |     |      |            |       |       |        |               |                         | STAINLESS |

Not intended for beer/beer configuration.

Depth measurement includes handles.

Height measurement includes mounting height and tap height.



### EXTERIOR FINISHES

- Black
- Stainless Steel

### INTERIOR FINISHES

- Galvanized steel with reinforced stainless steel floor
- Stainless steel

### AVAILABLE ACCESSORIES

- Club top
- 1-4 insulated stainless towers/taps
- Wine models available
- 2, 3, or 4-way manifolds
- Faucet locks
- No draft arm with hole cover

### AVAILABLE OPTIONS

- Outdoor approved unit available (BM23 only)

### MOUNTING OPTIONS

- 4" casters

# BACK BAR COOLERS

**Galvanized Steel Interior**

**Stainless Steel Floor**

**Full electronic control**

**Compressor Available on Left or Right Side**  
specify at time of order

**LED Lighting**

**Two Epoxy Coated Shelves per section**

**Stay Open Door and Locks**

**Field Reversible Doors**  
on select models

**Sliding Glass Doors**  
on select models (door frames only come in black)

**Pass Thru Models Available**

**Magnetic gasket attached to each door**  
for positive seal



## WIDE VARIETY OF OPTIONS AND ACCESSORIES

**3 YEAR PARTS & LABOR WARRANTY WITH  
AN ADDITIONAL 2 YEAR COMPRESSOR WARRANTY**

**MADE IN USA**



**LEFT OR RIGHT COMPRESSOR**  
Specify which side the compressor should be located at time of order



**OPEN FOOD RATED MODELS**  
for increased storage options

### ACCESS OPTIONS

- Hinge doors
- Slide doors
- Pass-thru

### AGENCY CERTIFICATIONS







**EXTERIOR FINISHES**

- Black
- Stainless Steel front/sides
- Stainless steel front with continuous coil coated sides

**INTERIOR FINISHES**

- Galvanized steel with reinforced stainless steel floor
- Stainless steel

**AVAILABLE ACCESSORIES**

- Wine models available
- Food rated models
- Glass door
- Stainless steel top and galvanized sub-tops available
- Extra shelves



**AVAILABLE OPTIONS**

- Left or right side compressor
- Remote models available

**MOUNTING OPTIONS**

- 6" casters
- 3" casters
- 6" legs

# BACK BAR COOLERS

## Standard

### SOLID DOORS

MAINTAINS PRODUCT TEMPERATURES OF 36-38°F.

| MODEL WIDTH | MODEL #       | DOORS/<br>SHELVES | VOLTS | HP  | AMPS | CUBIC<br>FEET | WIDTH | DEPTH | HEIGHT | CRATED<br>WEIGHT | # OF STRAIGHT<br>WALL KEGS | 12oz<br>CANS | 12oz<br>BOTTLES | LONGNECK<br>BOTTLES | FINISH |
|-------------|---------------|-------------------|-------|-----|------|---------------|-------|-------|--------|------------------|----------------------------|--------------|-----------------|---------------------|--------|
| 24"         | BB24HC-1-B    | 1/2               | 115   | 1/6 | 2    | 7.66          | 24    | 30.13 | 37.75  | 186              | 1                          | 180          | 140             | 110                 | BLACK  |
|             | 188           |                   |       |     |      |               |       |       |        | 1                | 180                        | 140          | 110             | STAINLESS FRONT     |        |
| 36"         | BB36HC-1-B    | 1/2               | 115   | 1/4 | 2.5  | 8.31          | 36    | 24.5  | 34     | 228              | 2                          | 240          | 220             | 170                 | BLACK  |
|             | 243           |                   |       |     |      |               |       |       |        | 2                | 240                        | 220          | 170             | STAINLESS           |        |
|             | BB36HC-1-B-27 | 1/2               | 115   | 1/4 | 2.5  | 8.31          | 36    | 24.5  | 36     | 232              | 2                          | 240          | 220             | 170                 | BLACK  |
|             | 243           |                   |       |     |      |               |       |       |        | 2                | 240                        | 220          | 170             | STAINLESS           |        |
| 48"         | BB48HC-1-B    | 2/4               | 115   | 1/4 | 2.5  | 12.4          | 48    | 24.5  | 34     | 270              | 2                          | 288          | 300             | 325                 | BLACK  |
|             | 306           |                   |       |     |      |               |       |       |        | 2                | 288                        | 300          | 325             | STAINLESS           |        |
|             | BB48HC-1-B-27 | 2/4               | 115   | 1/4 | 2.5  | 12.4          | 48    | 24.5  | 36     | 297              | 2                          | 288          | 300             | 325                 | BLACK  |
|             | 292           |                   |       |     |      |               |       |       |        | 2                | 288                        | 300          | 325             | STAINLESS           |        |
| 59"         | BB58HC-1-B    | 2/4               | 115   | 1/4 | 2.5  | 21.86         | 59    | 29.13 | 37.25  | 350              | 2                          | 528          | 440             | 365                 | BLACK  |
|             | 354           |                   |       |     |      |               |       |       |        | 2                | 528                        | 440          | 365             | STAINLESS FRONT     |        |
| 69"         | BB68HC-1-B    | 2/4               | 115   | 1/3 | 5.3  | 25.93         | 69    | 29.13 | 37.25  | 401              | 3                          | 672          | 550             | 435                 | BLACK  |
|             | 401           |                   |       |     |      |               |       |       |        | 3                | 672                        | 550          | 435             | STAINLESS FRONT     |        |
| 72"         | BB72HC-1-B    | 3/6               | 115   | 1/3 | 3.1  | 19.92         | 72    | 24.5  | 34     | 325              | 3                          | 540          | 480             | 505                 | BLACK  |
|             | 359           |                   |       |     |      |               |       |       |        | 3                | 540                        | 480          | 505             | STAINLESS           |        |
|             | BB72HC-1-B-27 | 3/6               | 115   | 1/3 | 3.1  | 19.92         | 72    | 24.5  | 36     | 325              | 3                          | 540          | 480             | 505                 | BLACK  |
|             | 359           |                   |       |     |      |               |       |       |        | 3                | 540                        | 480          | 505             | STAINLESS           |        |
| 79"         | BB78HC-1-B    | 3/6               | 115   | 1/3 | 5.5  | 33.59         | 79    | 29.13 | 37.25  | 448              | 4                          | 740          | 630             | 560                 | BLACK  |
|             | 444           |                   |       |     |      |               |       |       |        | 4                | 740                        | 630          | 560             | STAINLESS FRONT     |        |
| 95"         | BB94HC-1-B    | 3/6               | 115   | 1/3 | 5.5  | 37.82         | 95    | 29.13 | 37.25  | 494              | 5                          | 920          | 785             | 675                 | BLACK  |
|             | 494           |                   |       |     |      |               |       |       |        | 5                | 920                        | 785          | 675             | STAINLESS FRONT     |        |

Depth measurement includes handles.  
BB24 height measurement includes mounting height.

| AVAILABLE OPTIONS |                         |
|-------------------|-------------------------|
| SUFFIX            | OPTION                  |
| 27                | 2" Stainless steel top  |
| R                 | Remote models available |

Append suffix to model # when placing order. Ex: BB36HC-1-S-27

## GLASS DOORS (HINGED)

MAINTAINS PRODUCT TEMPERATURES OF 36-38°F.

| MODEL WIDTH | MODEL #         | DOORS/<br>SHELVES | VOLTS | HP  | AMPS | CUBIC<br>FEET | WIDTH | DEPTH | HEIGHT | CRATED<br>WEIGHT | # OF STRAIGHT<br>WALL KEGS | 12oz<br>CANS | 12oz<br>BOTTLES | LONGNECK<br>BOTTLES | FINISH          |
|-------------|-----------------|-------------------|-------|-----|------|---------------|-------|-------|--------|------------------|----------------------------|--------------|-----------------|---------------------|-----------------|
| 24"         | BB24HC-1-G-B    | 1/2               | 115   | 1/6 | 2    | 7.66          | 24    | 30.13 | 37.75  | 192              | 1                          | 180          | 140             | 110                 | BLACK           |
|             | 202             |                   |       |     |      |               |       |       |        | 1                | 180                        | 140          | 110             | STAINLESS FRONT     |                 |
| 36"         | BB36HC-1-G-B    | 1/2               | 115   | 1/4 | 2.5  | 8.36          | 36    | 24.50 | 34     | 232              | 2                          | 240          | 220             | 170                 | BLACK           |
|             | BB36HC-1-G-S    |                   |       |     |      |               |       |       |        | 243              | 2                          | 240          | 220             | 170                 | STAINLESS       |
|             | BB36HC-1-G-B-27 | 1/2               | 115   | 1/4 | 2.5  | 8.36          | 36    | 24.50 | 36     | 244              | 2                          | 240          | 220             | 170                 | BLACK           |
|             | BB36HC-1-G-S-27 |                   |       |     |      |               |       |       |        | 243              | 2                          | 240          | 220             | 170                 | STAINLESS       |
| 48"         | BB48HC-1-G-B    | 2/4               | 115   | 1/4 | 2.5  | 12.4          | 48    | 24.50 | 34     | 286              | 2                          | 288          | 300             | 325                 | BLACK           |
|             | BB48HC-1-G-S    |                   |       |     |      |               |       |       |        |                  |                            |              |                 |                     | STAINLESS       |
|             | BB48HC-1-G-B-27 | 2/4               | 115   | 1/4 | 2.5  | 12.4          | 48    | 24.50 | 36     | 296              | 2                          | 288          | 300             | 325                 | BLACK           |
|             | BB48HC-1-G-S-27 |                   |       |     |      |               |       |       |        |                  |                            |              |                 |                     | STAINLESS       |
| 59"         | BB58HC-1-G-B    | 2/4               | 115   | 1/4 | 2.5  | 21.86         | 59    | 29.13 | 37.25  | 354              | 2                          | 528          | 440             | 365                 | BLACK           |
|             | BB58HC-1-G-S    |                   |       |     |      |               |       |       |        |                  |                            |              |                 |                     | STAINLESS FRONT |
| 69"         | BB68HC-1-G-B    | 2/4               | 115   | 1/3 | 5.3  | 25.93         | 69    | 29.13 | 37.25  | 401              | 3                          | 672          | 550             | 435                 | BLACK           |
|             | BB68HC-1-G-S    |                   |       |     |      |               |       |       |        |                  |                            |              |                 |                     | STAINLESS FRONT |
| 72"         | BB72HC-1-G-B    | 3/6               | 115   | 1/3 | 3.1  | 19.92         | 72    | 24.50 | 34     | 375              | 3                          | 540          | 480             | 505                 | BLACK           |
|             | BB72HC-1-G-S    |                   |       |     |      |               |       |       |        | 388              | 3                          | 540          | 480             | 505                 | STAINLESS       |
|             | BB72HC-1-G-B-27 | 3/6               | 115   | 1/3 | 3.1  | 19.92         | 72    | 24.50 | 36     | 375              | 3                          | 540          | 480             | 505                 | BLACK           |
|             | BB72HC-1-G-S-27 |                   |       |     |      |               |       |       |        | 381              | 3                          | 540          | 480             | 505                 | STAINLESS       |
| 79"         | BB78HC-1-G-B    | 3/6               | 115   | 1/3 | 5.5  | 33.59         | 79    | 29.13 | 37.25  | 444              | 4                          | 740          | 630             | 560                 | BLACK           |
|             | BB78HC-1-G-S    |                   |       |     |      |               |       |       |        |                  |                            |              |                 |                     | STAINLESS FRONT |
| 95"         | BB94HC-1-G-B    | 3/6               | 115   | 1/3 | 5.5  | 37.82         | 95    | 29.13 | 37.25  | 544              | 5                          | 920          | 785             | 675                 | BLACK           |
|             | BB94HC-1-G-S    |                   |       |     |      |               |       |       |        |                  |                            |              |                 |                     | STAINLESS FRONT |

## GLASS DOORS (SLIDING) (Door frame only comes in black)

| MODEL WIDTH | MODEL #          | DOORS/<br>SHELVES | VOLTS | HP  | AMPS | CUBIC<br>FEET | WIDTH | DEPTH | HEIGHT | CRATED<br>WEIGHT | # OF STRAIGHT<br>WALL KEGS | 12oz<br>CANS | 12oz<br>BOTTLES | LONGNECK<br>BOTTLES | FINISH          |
|-------------|------------------|-------------------|-------|-----|------|---------------|-------|-------|--------|------------------|----------------------------|--------------|-----------------|---------------------|-----------------|
| 48"         | BB48HC-1-GS-B    | 2/4               | 115   | 1/4 | 2.5  | 12.4          | 48    | 23.63 | 34     | 278              | 2                          | 288          | 300             | 325                 | BLACK           |
|             | BB48HC-1-GS-S    |                   |       |     |      |               |       |       |        | 306              | 2                          | 288          | 300             | 325                 | STAINLESS       |
|             | BB48HC-1-GS-B-27 | 2/4               | 115   | 1/4 | 2.5  | 12.4          | 48    | 23.63 | 36     | 292              | 2                          | 288          | 300             | 325                 | BLACK           |
|             | BB48HC-1-GS-S-27 |                   |       |     |      |               |       |       |        | 306              | 2                          | 288          | 300             | 325                 | STAINLESS       |
| 59"         | BB58HC-1-GS-B    | 2/4               | 115   | 1/4 | 2.5  | 21.86         | 59    | 28.25 | 37.25  | 354              | 2                          | 528          | 440             | 365                 | BLACK           |
|             | BB58HC-1-GS-S    |                   |       |     |      |               |       |       |        |                  |                            |              |                 |                     | STAINLESS FRONT |
| 72"         | BB72HC-1-GS-B    | 3/6               | 115   | 1/3 | 3.1  | 19.92         | 72    | 23.63 | 34     | 381              | 3                          | 540          | 480             | 505                 | BLACK           |
|             | BB72HC-1-GS-S    |                   |       |     |      |               |       |       |        |                  |                            |              |                 |                     | STAINLESS       |
|             | BB72HC-1-GS-B-27 | 3/6               | 115   | 1/3 | 3.1  | 19.92         | 72    | 23.63 | 36     | 381              | 3                          | 540          | 480             | 505                 | BLACK           |
|             | BB72HC-1-GS-S-27 |                   |       |     |      |               |       |       |        |                  |                            |              |                 |                     | STAINLESS       |

*Depth measurement includes handles.  
BB24 height measurement includes mounting height.*

# BACK BAR COOLERS

## Pass-thru

### SOLID DOORS

MAINTAINS PRODUCT TEMPERATURES OF 36-38°F.

| MODEL WIDTH | MODEL #          | DOORS/<br>SHELVES | VOLTS | HP  | AMPS | CUBIC<br>FEET | WIDTH | DEPTH | HEIGHT | CRATED<br>WEIGHT | # OF STRAIGHT<br>WALL KEGS | 12oz<br>CANS | 12oz<br>BOTTLES | LONGNECK<br>BOTTLES | FINISH    |
|-------------|------------------|-------------------|-------|-----|------|---------------|-------|-------|--------|------------------|----------------------------|--------------|-----------------|---------------------|-----------|
| 48"         | BB48HC-1-PT-B    | 4/4               | 115   | 1/3 | 3.1  | 13.6          | 48    | 27.38 | 34     | 306              | 2                          | 288          | 300             | 325                 | BLACK     |
|             | BB48HC-1-PT-S    |                   |       |     |      |               |       |       |        |                  |                            |              |                 |                     | STAINLESS |
|             | BB48HC-1-PT-B-27 | 4/4               | 115   | 1/3 | 3.1  | 13.6          | 48    | 27.38 | 36     | 306              | 2                          | 288          | 300             | 325                 | BLACK     |
| 72"         | BB72HC-1-PT-B    | 6/6               | 115   | 1/3 | 3.1  | 22.1          | 72    | 27.38 | 34     | 381              | 3                          | 540          | 480             | 505                 | BLACK     |
|             | BB72HC-1-PT-S    |                   |       |     |      |               |       |       |        |                  |                            |              |                 |                     | STAINLESS |
|             | BB72HC-1-PT-B-27 | 6/6               | 115   | 1/3 | 3.1  | 22.1          | 72    | 27.38 | 36     | 359              | 3                          | 540          | 480             | 505                 | BLACK     |
|             | BB72HC-1-PT-S-27 |                   |       |     |      |               |       |       |        |                  |                            |              |                 |                     | STAINLESS |

*Depth measurement includes handles.*



## GLASS DOORS (HINGED)

MAINTAINS PRODUCT TEMPERATURES OF 36-38°F.

| MODEL WIDTH | MODEL #            | DOORS/<br>SHELVES | VOLTS | HP  | AMPS | CUBIC<br>FEET | WIDTH | DEPTH | HEIGHT | CRATED<br>WEIGHT | # OF STRAIGHT<br>WALL KEGS | 12oz<br>CANS | 12oz<br>BOTTLES | LONGNECK<br>BOTTLES | FINISH    |
|-------------|--------------------|-------------------|-------|-----|------|---------------|-------|-------|--------|------------------|----------------------------|--------------|-----------------|---------------------|-----------|
| 48"         | BB48HC-1-G-PT-B    | 4/4               | 115   | 1/3 | 3.1  | 13.6          | 48    | 27.38 | 34     | 316              | 2                          | 288          | 300             | 325                 | BLACK     |
|             | BB48HC-1-G-PT-S    |                   |       |     |      |               |       |       |        |                  |                            |              |                 |                     | STAINLESS |
|             | BB48HC-1-G-PT-B-27 | 4/4               | 115   | 1/3 | 3.1  | 13.6          | 48    | 27.38 | 36     | 334              | 2                          | 288          | 300             | 325                 | BLACK     |
|             | BB48HC-1-G-PT-S-27 |                   |       |     |      |               |       |       |        |                  |                            |              |                 |                     | STAINLESS |
| 72"         | BB72HC-1-G-PT-B    | 6/6               | 115   | 1/3 | 3.1  | 22.1          | 72    | 27.38 | 34     | 425              | 3                          | 540          | 480             | 505                 | BLACK     |
|             | BB72HC-1-G-PT-S    |                   |       |     |      |               |       |       |        |                  |                            |              |                 |                     | STAINLESS |
|             | BB72HC-1-G-PT-B-27 | 6/6               | 115   | 1/3 | 3.1  | 22.1          | 72    | 27.38 | 36     | 425              | 3                          | 540          | 480             | 505                 | BLACK     |
|             | BB72HC-1-G-PT-S-27 |                   |       |     |      |               |       |       |        |                  |                            |              |                 |                     | STAINLESS |

## GLASS DOORS (SLIDING) (Door frame only comes in black)

| MODEL WIDTH | MODEL #             | DOORS/<br>SHELVES | VOLTS | HP  | AMPS | CUBIC<br>FEET | WIDTH | DEPTH | HEIGHT | CRATED<br>WEIGHT | # OF STRAIGHT<br>WALL KEGS | 12oz<br>CANS | 12oz<br>BOTTLES | LONGNECK<br>BOTTLES | FINISH    |
|-------------|---------------------|-------------------|-------|-----|------|---------------|-------|-------|--------|------------------|----------------------------|--------------|-----------------|---------------------|-----------|
| 48"         | BB48HC-1-GS-PT-B    | 4/4               | 115   | 1/3 | 3.1  | 13.6          | 48    | 25.75 | 34     | 316              | 2                          | 288          | 300             | 325                 | BLACK     |
|             | BB48HC-1-GS-PT-S    |                   |       |     |      |               |       |       |        |                  |                            |              |                 |                     | STAINLESS |
|             | BB48HC-1-GS-PT-B-27 | 4/4               | 115   | 1/3 | 3.1  | 13.6          | 48    | 25.75 | 36     | 316              | 2                          | 288          | 300             | 325                 | BLACK     |
|             | BB48HC-1-GS-PT-S-27 |                   |       |     |      |               |       |       |        |                  |                            |              |                 |                     | STAINLESS |
| 72"         | BB72HC-1-GS-PT-B    | 6/6               | 115   | 1/3 | 3.1  | 22.1          | 72    | 23.75 | 34     | 408              | 3                          | 540          | 480             | 505                 | BLACK     |
|             | BB72HC-1-GS-PT-S    |                   |       |     |      |               |       |       |        |                  |                            |              |                 |                     | STAINLESS |
|             | BB72HC-1-GS-PT-B-27 | 6/6               | 115   | 1/3 | 3.1  | 22.1          | 72    | 23.75 | 36     | 448              | 3                          | 540          | 480             | 505                 | BLACK     |
|             | BB72HC-1-GS-PT-S-27 |                   |       |     |      |               |       |       |        |                  |                            |              |                 |                     | STAINLESS |

*Depth measurement includes handles.*

### AVAILABLE OPTIONS

| SUFFIX    | OPTION                  |
|-----------|-------------------------|
| <b>27</b> | 2" Stainless steel top  |
| <b>R</b>  | Remote models available |

Append suffix to model # when placing order. Ex: BB36HC-1-S-27

# BACK BAR COOLERS

## Food Rated

### SOLID DOORS

MAINTAINS PRODUCT TEMPERATURES OF 36-38°F.

| MODEL WIDTH | MODEL #         | DOORS/<br>SHELVES | VOLTS | HP  | AMPS | CUBIC<br>FEET | WIDTH | DEPTH | HEIGHT | CRATED<br>WEIGHT | # OF STRAIGHT<br>WALL KEGS | 12oz<br>CANS | 12oz<br>BOTTLES | LONGNECK<br>BOTTLES | FINISH          |
|-------------|-----------------|-------------------|-------|-----|------|---------------|-------|-------|--------|------------------|----------------------------|--------------|-----------------|---------------------|-----------------|
| 24"         | BB24HC-1-F-B    | 1/2               | 115   | 1/6 | 2    | 7.66          | 24    | 30.13 | 37.75  | 200              | 1                          | 180          | 140             | 110                 | BLACK           |
|             | BB24HC-1-F-S    |                   |       |     |      |               |       |       |        |                  |                            |              |                 |                     | STAINLESS FRONT |
| 36"         | BB36HC-1-F-B    | 1/2               | 115   | 1/4 | 2.5  | 8.31          | 36    | 24.5  | 34     | 232              | 2                          | 240          | 220             | 170                 | BLACK           |
|             | BB36HC-1-F-S    |                   |       |     |      |               |       |       |        |                  |                            |              |                 |                     | STAINLESS       |
|             | BB36HC-1-F-B-27 | 1/2               | 115   | 1/4 | 2.5  | 8.31          | 36    | 24.5  | 36     | 243              | 2                          | 240          | 220             | 170                 | BLACK           |
|             | BB36HC-1-F-S-27 |                   |       |     |      |               |       |       |        |                  |                            |              |                 |                     | STAINLESS       |
| 48"         | BB48HC-1-F-B    | 2/4               | 115   | 1/4 | 2.5  | 12.4          | 48    | 24.5  | 34     | 284              | 2                          | 288          | 300             | 325                 | BLACK           |
|             | BB48HC-1-F-S    |                   |       |     |      |               |       |       |        |                  |                            |              |                 |                     | STAINLESS       |
|             | BB48HC-1-F-B-27 | 2/4               | 115   | 1/4 | 2.5  | 12.4          | 48    | 24.5  | 36     | 320              | 2                          | 288          | 300             | 325                 | BLACK           |
|             | BB48HC-1-F-S-27 |                   |       |     |      |               |       |       |        |                  |                            |              |                 |                     | STAINLESS       |
| 59"         | BB58HC-1-F-B    | 2/4               | 115   | 1/4 | 2.5  | 21.86         | 59    | 29.13 | 37.25  | 354              | 2                          | 528          | 440             | 365                 | BLACK           |
|             | BB58HC-1-F-S    |                   |       |     |      |               |       |       |        |                  |                            |              |                 |                     | STAINLESS FRONT |
| 69"         | BB68HC-1-F-B    | 2/4               | 115   | 1/3 | 5.3  | 25.93         | 69    | 29.13 | 37.25  | 410              | 3                          | 672          | 550             | 435                 | BLACK           |
|             | BB68HC-1-F-S    |                   |       |     |      |               |       |       |        |                  |                            |              |                 |                     | STAINLESS FRONT |
| 72"         | BB72HC-1-F-B    | 3/6               | 115   | 1/3 | 3.1  | 19.92         | 72    | 24.50 | 34     | 325              | 3                          | 540          | 480             | 505                 | BLACK           |
|             | BB72HC-1-F-S    |                   |       |     |      |               |       |       |        |                  |                            |              |                 |                     | STAINLESS       |
|             | BB72HC-1-F-B-27 | 3/6               | 115   | 1/3 | 3.1  | 19.92         | 72    | 24.50 | 36     | 325              | 3                          | 540          | 480             | 505                 | BLACK           |
|             | BB72HC-1-F-S-27 |                   |       |     |      |               |       |       |        |                  |                            |              |                 |                     | STAINLESS       |
| 79"         | BB78HC-1-F-B    | 3/6               | 115   | 1/3 | 5.5  | 33.59         | 79    | 29.13 | 37.25  | 375              | 4                          | 740          | 630             | 560                 | BLACK           |
|             | BB78HC-1-F-S    |                   |       |     |      |               |       |       |        |                  |                            |              |                 |                     | STAINLESS FRONT |
| 95"         | BB94HC-1-F-B    | 3/6               | 115   | 1/3 | 5.5  | 37.82         | 95    | 29.13 | 37.25  | 510              | 5                          | 920          | 785             | 675                 | BLACK           |
|             | BB94HC-1-F-S    |                   |       |     |      |               |       |       |        |                  |                            |              |                 |                     | STAINLESS FRONT |

Depth measurement includes handles.  
BB24 height measurement includes mounting height.

| AVAILABLE OPTIONS |                         |
|-------------------|-------------------------|
| SUFFIX            | OPTION                  |
| 27                | 2" Stainless steel top  |
| R                 | Remote models available |

Append suffix to model # when placing order. Ex: BB36HC-1-S-27

## GLASS DOORS (HINGED)

MAINTAINS PRODUCT TEMPERATURES OF 36-38°F.

| MODEL WIDTH | MODEL #          | DOORS/SHELVES | VOLTS | HP  | AMPS | CUBIC FEET | WIDTH | DEPTH | HEIGHT | CRATED WEIGHT | # OF STRAIGHT WALL KEGS | 12oz CANS | 12oz BOTTLES | LONGNECK BOTTLES | FINISH          |
|-------------|------------------|---------------|-------|-----|------|------------|-------|-------|--------|---------------|-------------------------|-----------|--------------|------------------|-----------------|
| 24"         | BB24HC-1-FG-B    | 1/2           | 115   | 1/6 | 2    | 7.66       | 24    | 30.13 | 37.75  | 200           | 1                       | 180       | 140          | 110              | BLACK           |
|             | BB24HC-1-FG-S    |               |       |     |      |            |       |       |        |               |                         |           |              |                  | STAINLESS FRONT |
| 36"         | BB36HC-1-FG-B    | 1/2           | 115   | 1/4 | 2.5  | 8.36       | 36    | 24.50 | 34     | 250           | 2                       | 240       | 220          | 170              | BLACK           |
|             | BB36HC-1-FG-S    |               |       |     |      |            |       |       |        |               |                         |           |              |                  | STAINLESS       |
|             | BB36HC-1-FG-B-27 | 1/2           | 115   | 1/4 | 2.5  | 8.36       | 36    | 24.50 | 36     | 250           | 2                       | 240       | 220          | 170              | BLACK           |
|             | BB36HC-1-FG-S-27 |               |       |     |      |            |       |       |        |               |                         |           |              |                  | STAINLESS       |
| 48"         | BB48HC-1-FG-B    | 2/4           | 115   | 1/4 | 2.5  | 12.4       | 48    | 24.50 | 34     | 320           | 2                       | 288       | 300          | 325              | BLACK           |
|             | BB48HC-1-FG-S    |               |       |     |      |            |       |       |        |               |                         |           |              |                  | STAINLESS       |
|             | BB48HC-1-FG-B-27 | 2/4           | 115   | 1/4 | 2.5  | 12.4       | 48    | 24.50 | 36     | 320           | 2                       | 288       | 300          | 325              | BLACK           |
|             | BB48HC-1-FG-S-27 |               |       |     |      |            |       |       |        |               |                         |           |              |                  | STAINLESS       |
| 59"         | BB58HC-1-FG-B    | 2/4           | 115   | 1/4 | 2.5  | 21.86      | 59    | 29.13 | 37.25  | 354           | 2                       | 528       | 440          | 365              | BLACK           |
|             | BB58HC-1-FG-S    |               |       |     |      |            |       |       |        |               |                         |           |              |                  | STAINLESS FRONT |
| 69"         | BB68HC-1-FG-B    | 2/4           | 115   | 1/3 | 5.3  | 25.93      | 69    | 29.13 | 37.25  | 401           | 3                       | 672       | 550          | 435              | BLACK           |
| 72"         | BB72HC-1-FG-B    | 3/6           | 115   | 1/3 | 3.1  | 19.92      | 72    | 24.50 | 34     | 325           | 3                       | 540       | 480          | 505              | BLACK           |
|             | BB72HC-1-FG-S    |               |       |     |      |            |       |       |        |               |                         |           |              |                  | STAINLESS       |
|             | BB72HC-1-FG-B-27 | 3/6           | 115   | 1/3 | 3.1  | 19.92      | 72    | 24.50 | 36     | 410           | 3                       | 540       | 480          | 505              | BLACK           |
|             | BB72HC-1-FG-S-27 |               |       |     |      |            |       |       |        |               |                         |           |              |                  | STAINLESS       |
| 79"         | BB78HC-1-FG-B    | 3/6           | 115   | 1/3 | 5.5  | 33.59      | 79    | 29.13 | 37.25  | 476           | 4                       | 740       | 630          | 560              | BLACK           |
|             | BB78HC-1-FG-S    |               |       |     |      |            |       |       |        |               |                         |           |              |                  | STAINLESS FRONT |
| 95"         | BB94HC-1-FG-B    | 3/6           | 115   | 1/3 | 5.5  | 37.82      | 95    | 29.13 | 37.25  | 544           | 5                       | 920       | 785          | 675              | BLACK           |
|             | BB94HC-1-FG-S    |               |       |     |      |            |       |       |        |               |                         |           |              |                  | STAINLESS FRONT |

## GLASS DOORS (SLIDING) (Door frame only comes in black)

| MODEL WIDTH | MODEL #            | DOORS/SHELVES | VOLTS | HP  | AMPS | CUBIC FEET | WIDTH | DEPTH | HEIGHT | CRATED WEIGHT | # OF STRAIGHT WALL KEGS | 12oz CANS | 12oz BOTTLES | LONGNECK BOTTLES | FINISH    |
|-------------|--------------------|---------------|-------|-----|------|------------|-------|-------|--------|---------------|-------------------------|-----------|--------------|------------------|-----------|
| 48"         | BB48HC-1-F-GS-B    | 2/4           | 115   | 1/4 | 2.5  | 12.4       | 48    | 23.63 | 34     | 284           | 2                       | 288       | 300          | 325              | BLACK     |
|             | BB48HC-1-F-GS-S    |               |       |     |      |            |       |       |        |               |                         |           |              |                  | STAINLESS |
|             | BB48HC-1-F-GS-B-27 | 2/4           | 115   | 1/4 | 2.5  | 12.4       | 48    | 23.63 | 36     | 300           | 2                       | 288       | 300          | 325              | BLACK     |
|             | BB48HC-1-F-GS-S-27 |               |       |     |      |            |       |       |        |               |                         |           |              |                  | STAINLESS |
| 59"         | BB58HC-1-F-GS-B    | 2/4           | 115   | 1/4 | 2.5  | 21.86      | 59    | 28.25 | 37.25  | 352           | 2                       | 528       | 440          | 365              | BLACK     |
| 72"         | BB72HC-1-F-GS-B    | 3/6           | 115   | 1/3 | 3.1  | 19.92      | 72    | 23.63 | 34     | 392           | 3                       | 540       | 480          | 505              | BLACK     |
|             | BB72HC-1-F-GS-S    |               |       |     |      |            |       |       |        |               |                         |           |              |                  | STAINLESS |
|             | BB72HC-1-F-GS-B-27 | 3/6           | 115   | 1/3 | 3.1  | 19.92      | 72    | 23.63 | 36     | 392           | 3                       | 540       | 480          | 505              | BLACK     |
|             | BB72HC-1-F-GS-S-27 |               |       |     |      |            |       |       |        |               |                         |           |              |                  | STAINLESS |

*Depth measurement includes handles.  
BB24 height measurement includes mounting height.*

# BACK BAR COOLERS

## Food Rated Pass-thru

### SOLID DOORS

MAINTAINS PRODUCT TEMPERATURES OF 36-38°F.

| MODEL WIDTH | MODEL #            | DOORS/SHELVES | VOLTS | HP  | AMPS | CUBIC FEET | WIDTH | DEPTH | HEIGHT | CRATED WEIGHT | # OF STRAIGHT WALL KEGS | 12oz CANS | 12oz BOTTLES | LONGNECK BOTTLES | FINISH    |
|-------------|--------------------|---------------|-------|-----|------|------------|-------|-------|--------|---------------|-------------------------|-----------|--------------|------------------|-----------|
| 48"         | BB48HC-1-F-PT-B    | 4/4           | 115   | 1/3 | 3.1  | 13.6       | 48    | 27.38 | 34     | 302           | 2                       | 288       | 300          | 325              | BLACK     |
|             | BB48HC-1-F-PT-S    |               |       |     |      |            |       |       |        |               |                         |           |              |                  | STAINLESS |
|             | BB48HC-1-F-PT-B-27 | 4/4           | 115   | 1/3 | 3.1  | 13.6       | 48    | 27.38 | 36     | 302           | 2                       | 288       | 300          | 325              | BLACK     |
|             | BB48HC-1-F-PT-S-27 |               |       |     |      |            |       |       |        |               |                         |           |              |                  | STAINLESS |
| 72"         | BB72HC-1-F-PT-B    | 6/6           | 115   | 1/3 | 3.1  | 22.1       | 72    | 27.38 | 34     | 375           | 3                       | 540       | 480          | 505              | BLACK     |
|             | BB72HC-1-F-PT-S    |               |       |     |      |            |       |       |        |               |                         |           |              |                  | STAINLESS |
|             | BB72HC-1-F-PT-B-27 | 6/6           | 115   | 1/3 | 3.1  | 22.1       | 72    | 27.38 | 36     | 375           | 3                       | 540       | 480          | 505              | BLACK     |
|             | BB72HC-1-F-PT-S-27 |               |       |     |      |            |       |       |        |               |                         |           |              |                  | STAINLESS |

Depth measurement includes handles.

### AVAILABLE OPTIONS

| SUFFIX    | OPTION                  |
|-----------|-------------------------|
| <b>27</b> | 2" Stainless steel top  |
| <b>R</b>  | Remote models available |

Append suffix to model # when placing order. Ex: BB36HC-1-S-27





## GLASS DOORS (HINGED)

MAINTAINS PRODUCT TEMPERATURES OF 36-38°F.

| MODEL WIDTH | MODEL #              | DOORS/SHELVES | VOLTS | HP  | AMPS | CUBIC FEET | WIDTH | DEPTH | HEIGHT | CRATED WEIGHT | # OF STRAIGHT WALL KEGS | 12oz CANS | 12oz BOTTLES | LONGNECK BOTTLES | FINISH    |
|-------------|----------------------|---------------|-------|-----|------|------------|-------|-------|--------|---------------|-------------------------|-----------|--------------|------------------|-----------|
| 48"         | BB48HC-1-FG-PT-B     | 4/4           | 115   | 1/3 | 3.1  | 13.6       | 48    | 27.38 | 34     | 320           | 2                       | 288       | 300          | 325              | BLACK     |
|             | BB48HC-1-FG-PT-S     |               |       |     |      |            |       |       |        |               |                         |           |              |                  | STAINLESS |
|             | BB48HC-1-FG-PT-B-27  | 4/4           | 115   | 1/3 | 3.1  | 13.6       | 48    | 27.38 | 36     | 302           | 2                       | 288       | 300          | 325              | BLACK     |
|             | BB48HC-1-FG-PT-S-27  |               |       |     |      |            |       |       |        |               |                         |           |              |                  | STAINLESS |
| 72"         | BB72HC-1-F-G-PT-B    | 6/6           | 115   | 1/3 | 3.1  | 22.1       | 72    | 27.38 | 34     | 456           | 3                       | 540       | 480          | 505              | BLACK     |
|             | BB72HC-1-F-G-PT-S    |               |       |     |      |            |       |       |        |               |                         |           |              |                  | STAINLESS |
|             | BB72HC-1-F-G-PT-B-27 | 6/6           | 115   | 1/3 | 3.1  | 22.1       | 72    | 27.38 | 36     | 456           | 3                       | 540       | 480          | 505              | BLACK     |
|             | BB72HC-1-F-G-PT-S-27 |               |       |     |      |            |       |       |        |               |                         |           |              |                  | STAINLESS |

## GLASS DOORS (SLIDING) (Door frame only comes in black)

| MODEL WIDTH | MODEL #               | DOORS/SHELVES | VOLTS | HP  | AMPS | CUBIC FEET | WIDTH | DEPTH | HEIGHT | CRATED WEIGHT | # OF STRAIGHT WALL KEGS | 12oz CANS | 12oz BOTTLES | LONGNECK BOTTLES | FINISH    |
|-------------|-----------------------|---------------|-------|-----|------|------------|-------|-------|--------|---------------|-------------------------|-----------|--------------|------------------|-----------|
| 48"         | BB48HC-1-GS-F-PT-B    | 4/4           | 115   | 1/3 | 3.1  | 13.6       | 48    | 25.75 | 34     | 316           | 2                       | 288       | 300          | 325              | BLACK     |
|             | BB48HC-1-GS-F-PT-S    |               |       |     |      |            |       |       |        |               |                         |           |              |                  | STAINLESS |
|             | BB48HC-1-GS-F-PT-B-27 | 4/4           | 115   | 1/3 | 3.1  | 13.6       | 48    | 25.75 | 36     | 316           | 2                       | 288       | 300          | 325              | BLACK     |
|             | BB48HC-1-GS-F-PT-S-27 |               |       |     |      |            |       |       |        |               |                         |           |              |                  | STAINLESS |
| 72"         | BB72HC-1-GS-F-PT-B    | 6/6           | 115   | 1/3 | 3.1  | 22.1       | 72    | 23.75 | 34     | 366           | 3                       | 540       | 480          | 505              | BLACK     |
|             | BB72HC-1-GS-F-PT-S    |               |       |     |      |            |       |       |        |               |                         |           |              |                  | STAINLESS |
|             | BB72HC-1-GS-F-PT-B-27 | 6/6           | 115   | 1/3 | 3.1  | 22.1       | 72    | 23.75 | 36     | 366           | 3                       | 540       | 480          | 505              | BLACK     |
|             | BB72HC-1-GS-F-PT-S-27 |               |       |     |      |            |       |       |        |               |                         |           |              |                  | STAINLESS |

*Depth measurement includes handles.*

# BOTTLE COOLERS

**Galvanized Steel Interior**

**Stainless Steel Floor**

**Full electronic temperature control**

**100% Metal lids**  
toughest in the industry to prevent bowing of lids

**Stainless steel top**

**Easy-glide metal lids and raised edge**

**Bottle opener and cap catcher standard**

**Adjustable wire dividers**



**3 YEAR PARTS & LABOR WARRANTY WITH AN ADDITIONAL 2 YEAR COMPRESSOR WARRANTY**

**MADE IN USA**



**ADJUSTABLE DIVIDERS**  
to organize cooler to meet your specific needs



**100% METAL LIDS**  
toughest in the industry to prevent bowing of lids

## ACCESS OPTIONS

- Metal lids

## AGENCY CERTIFICATIONS



## FROSTY BREW™ 30-32°

MAINTAINS PRODUCT TEMPERATURES OF 30-32°F.

| MODEL WIDTH | MODEL #     | LIDS/<br>DIVIDERS | VOLTS | HP  | AMPS | CUBIC<br>FEET | WIDTH | DEPTH | HEIGHT | CRATED<br>WEIGHT | FINISH             |
|-------------|-------------|-------------------|-------|-----|------|---------------|-------|-------|--------|------------------|--------------------|
| 50"         | DW49HC-B-29 | 2/3               | 115   | 1/4 | 2.5  | 13.7          | 50    | 26.5  | 33.75  | 272              | BLACK              |
|             | DW49HC-S-29 |                   |       |     |      |               |       |       |        | 274              | STAINLESS<br>FRONT |
| 65"         | DW64HC-B-29 | 2/4               | 115   | 1/4 | 2.5  | 18.5          | 65    | 26.5  | 33.75  | 322              | BLACK              |
|             | DW64HC-S-29 |                   |       |     |      |               |       |       |        | 332              | STAINLESS<br>FRONT |
| 80"         | DW79HC-B-29 | 3/5               | 115   | 1/4 | 2.5  | 24.1          | 80    | 26.5  | 33.75  | 390              | BLACK              |
|             | DW79HC-S-29 |                   |       |     |      |               |       |       |        | 432              | STAINLESS<br>FRONT |
| 95"         | DW94HC-B-29 | 4/6               | 115   | 1/4 | 2.5  | 28.63         | 95    | 26.5  | 33.75  | 450              | BLACK              |
|             | DW94HC-S-29 |                   |       |     |      |               |       |       |        | 456              | STAINLESS<br>FRONT |

## STANDARD 36-40°

MAINTAINS PRODUCT TEMPERATURES OF 36-40°F.

| MODEL WIDTH | MODEL #  | LIDS/<br>DIVIDERS | VOLTS | HP  | AMPS | CUBIC<br>FEET | WIDTH | DEPTH | HEIGHT | CRATED<br>WEIGHT | FINISH             |
|-------------|----------|-------------------|-------|-----|------|---------------|-------|-------|--------|------------------|--------------------|
| 35"         | SF34-B   | 1/0               | 115   | 1/5 | 4.5  | 7.5           | 34.88 | 26.5  | 33.63  | 210              | BLACK              |
|             | SF34-SS  |                   |       |     |      |               |       |       |        | 228              | STAINLESS<br>FRONT |
| 50"         | DW49HC-B | 2/3               | 115   | 1/4 | 2.5  | 13.7          | 50    | 26.5  | 33.75  | 272              | BLACK              |
|             | DW49HC-S |                   |       |     |      |               |       |       |        | 274              | STAINLESS<br>FRONT |
| 65"         | DW64HC-B | 2/4               | 115   | 1/4 | 2.5  | 18.5          | 65    | 26.5  | 33.75  | 322              | BLACK              |
|             | DW64HC-S |                   |       |     |      |               |       |       |        | 332              | STAINLESS<br>FRONT |
| 80"         | DW79HC-B | 3/5               | 115   | 1/4 | 2.5  | 24.1          | 80    | 26.5  | 33.75  | 390              | BLACK              |
|             | DW79HC-S |                   |       |     |      |               |       |       |        | 432              | STAINLESS<br>FRONT |
| 95"         | DW94HC-B | 4/6               | 115   | 1/4 | 2.5  | 28.63         | 95    | 26.5  | 33.75  | 450              | BLACK              |
|             | DW94HC-S |                   |       |     |      |               |       |       |        | 456              | STAINLESS<br>FRONT |

*Depth measurement includes handles.  
Height measurement includes mounting height.*

### EXTERIOR FINISHES

- Black
- Stainless Steel

### INTERIOR FINISHES

- Galvanized steel with reinforced stainless steel floor
- Stainless steel

### AVAILABLE ACCESSORIES

- Frosty brew model (30-32° F)
- Extra wide dividers
- Locks

### MOUNTING OPTIONS

- 3" casters
- 6" legs

### AVAILABLE OPTIONS

- Remote models available



# GLASS & PLATE CHILLERS

**Front or Top Loading**

**Interior thermometer**

**Self-closing door with 120° stay-open feature**  
(Front Loading Models)

**Field-reversible door**  
(Front Loading Models)

**Easy door removal**  
for service and cleaning (Top Loading)

**Magnetic gasket attached to each door**  
for positive seal

**Auto-defrost**

**Built-in Condensate Evaporator System**

**Operating Temperature -10F**

**Two Epoxy Coated Shelves**

**R290 Refrigerant**



**3 YEAR PARTS & LABOR WARRANTY WITH  
AN ADDITIONAL 2 YEAR COMPRESSOR WARRANTY**  
**MADE IN USA**



**ADJUSTABLE DIVIDERS**  
to organize cooler to meet your  
specific needs



**100% METAL LIDS**  
toughest in the industry to prevent  
bowing of lids

## ACCESS OPTIONS

- Doors
- Metal lids

## AGENCY CERTIFICATIONS



## FRONT LOADING

CHILLS TO -10°F, PRODUCING FROST WHEN REMOVED

| MODEL WIDTH | MODEL #     | DOORS/<br>SHELVES | VOLTS | HP  | AMPS | CUBIC<br>FEET | WIDTH | DEPTH | HEIGHT | CRATED<br>WEIGHT | CASE CAPACITY |              | FINISH    |
|-------------|-------------|-------------------|-------|-----|------|---------------|-------|-------|--------|------------------|---------------|--------------|-----------|
|             |             |                   |       |     |      |               |       |       |        |                  | 12oz<br>MUGS  | 8"<br>PLATES |           |
| 24"         | FLG24HC-1-B | 1/2               | 115   | 1/4 | 2.5  | 5.06          | 24    | 30.13 | 32     | 208              | 80            | 100          | BLACK     |
|             | FLG24HC-1-S |                   |       |     |      |               |       |       |        |                  |               |              | STAINLESS |

Depth measurement includes handles.

## TOP LOADING

CHILLS TO -10°F, PRODUCING FROST WHEN REMOVED

| MODEL WIDTH | MODEL # | LIDS/<br>DIVIDERS | VOLTS | HP  | AMPS | CUBIC<br>FEET | WIDTH | DEPTH | HEIGHT | CRATED<br>WEIGHT | CASE CAPACITY |              | FINISH    |
|-------------|---------|-------------------|-------|-----|------|---------------|-------|-------|--------|------------------|---------------|--------------|-----------|
|             |         |                   |       |     |      |               |       |       |        |                  | 12oz<br>MUGS  | 8"<br>PLATES |           |
| 24"         | GF24L-B | 1/2               | 115   | 1/2 | 7    | 3.67          | 24    | 26.13 | 33.63  | 186              | 76            | 100          | BLACK     |
|             | GF24L-S |                   |       |     |      |               |       |       |        |                  |               |              | STAINLESS |
| 34"         | GF34L-B | 1/2               | 115   | 1/2 | 6.5  | 6.6           | 34    | 26.13 | 33.63  | 223              | 94            | 150          | BLACK     |
|             | GF34L-S |                   |       |     |      |               |       |       |        |                  |               |              | STAINLESS |
| 48"         | GF48L-B | 2/4               | 115   | 1/2 | 7.5  | 9.6           | 48    | 26.13 | 33.63  | 292              | 164           | 250          | BLACK     |
|             | GF48L-S |                   |       |     |      |               |       |       |        |                  |               |              | STAINLESS |

Depth measurement includes handles.



### EXTERIOR FINISHES

- Black
- Stainless Steel

### INTERIOR FINISHES

- Galvanized steel with reinforced stainless steel floor
- Stainless steel

### AVAILABLE ACCESSORIES

- Locks factory installed available for GF24L & GF34L

### AVAILABLE OPTIONS

- Remote models available

### MOUNTING OPTIONS

- 3" casters (GF models only)
- 6" legs (GF models only)

# Bar & Wine Accessories

| DESCRIPTION                  | UNIT(S)                         | PART NUMBER |
|------------------------------|---------------------------------|-------------|
| <b>SHELVING / ORGANIZERS</b> |                                 |             |
| Epoxy Coated Wire Shelf      | DD48                            | 403-322D    |
| Epoxy Coated Wire Shelf      | DD50/50C Shelf Kit (set of 2)   | 00C21-022A  |
| Epoxy Coated Wire Shelf      | DD58 Shelf Kit (set of 2)       | 00C21-007A  |
| Epoxy Coated Wire Shelf      | DD68 Shelf Kit (set of 2)       | 00C21-006A  |
| Epoxy Coated Wire Shelf      | DD72                            | 403-326D    |
| Epoxy Coated Wire Shelf      | DD78 Shelf Kit (set of 3)       | 00C21-023A  |
| Epoxy Coated Wire Shelf      | DD94 Center Shelf               | 403-216D    |
| Epoxy Coated Wire Shelf      | DD94 Right Shelf                | 403-249D    |
| Epoxy Coated Wire Shelf      | DD94 Left Shelf                 | 403-690D-01 |
| Epoxy Coated Wire Shelf      | BB24                            | 403-922D-02 |
| Epoxy Coated Wire Shelf      | BB36                            | 403-924D-02 |
| Epoxy Coated Wire Shelf      | BB48/48G                        | 403-322D    |
| Epoxy Coated Wire Shelf      | BB58/58G LH                     | 403-218D    |
| Epoxy Coated Wire Shelf      | BB58/58G RH                     | 403-249D    |
| Epoxy Coated Wire Shelf      | BB68/68G                        | 403-217D    |
| Epoxy Coated Wire Shelf      | BB72/72G                        | 403-326D    |
| Epoxy Coated Wire Shelf      | BB78/78G CTR                    | 403-582D    |
| Epoxy Coated Wire Shelf      | BB78/78G LH                     | 403-583D    |
| Epoxy Coated Wire Shelf      | BB78/78G RH                     | 403-584D    |
| Epoxy Coated Wire Shelf      | BB94/94G CTR                    | 403-216D    |
| Epoxy Coated Wire Shelf      | BB94/94G RH                     | 403-249D    |
| Epoxy Coated Wire Shelf      | BB94/94G LH                     | 403-690D-01 |
| Epoxy Coated Wire Shelf      | DP46/67/93/119, DPD46/67/93/119 | 403-834D    |
| Shelf Clip                   | DD48/72/94                      | 403-168A    |
| Shelf Clip                   | All BB's                        | 403-168A    |
| All Epoxy Coated Shelves     | BB24                            | 403-942D-01 |
| All Epoxy Coated Shelves     | BB36                            | 403-722C    |
| All Epoxy Coated Shelves     | BB48                            | 403-722C    |
| All Epoxy Coated Shelves     | BB58/BB68                       | 403-719C    |
| All Epoxy Coated Shelves     | BB72                            | 403-722C    |
| All Epoxy Coated Shelves     | BB78                            | 403-719C    |
| All Epoxy Coated Shelves     | BB94                            | 403-719C    |

| DESCRIPTION                    | UNIT(S)                               | PART NUMBER  |
|--------------------------------|---------------------------------------|--------------|
| <b>MOUNTING</b>                |                                       |              |
| 6" Caster                      | BB24/BB36                             | 00C31-038A   |
| 6" Caster                      | BB48, BB72 (set of four)              | 00C31-038A   |
| 3" Caster                      | BB48, BB72 (set of four)              | 00C31-041A   |
| 3" Caster                      | BB58, BB68 (set of four)              | 00C26-012A   |
| 3" Caster                      | BB78, BB94 (set of six)               | 00C26-017A   |
| 3" Caster                      | DD36                                  | 00C31-041A   |
| 6" Caster                      | DD36                                  | 00C31-038A   |
| 6" Caster                      | DD48, DD72 (set of four)              | 00C31-038A   |
| 3" Caster                      | DD48, DD72 (set of four)              | 00C31-041A   |
| 3" Caster                      | DD50, DD58, DD68 (set of four)        | 00C26-012A   |
| 3" Caster                      | DD78, DD94 (set of six)               | 00C26-017A   |
| 3" Caster                      | DW49 (set of four)                    | 00C31-034ABB |
| 3" Caster                      | DW64 (set of four)                    | 00C31-031ABB |
| 3" Caster                      | DW79, DW94 (set of six)               | 00C31-030ABB |
| 3" Plate Casters               | SF34 (set of four)                    | 00C28S092AAA |
| 3" Caster                      | GF24, 34, 48 (set of four)            | 00C28S110A-- |
| 6" Adjustable with Plate       | DW49 ( set of four)                   | 00C31-036A-- |
| 6" Adjustable with Plate       | DW64 ( set of four)                   | 00C31-033ABB |
| 6" Adjustable with Plate       | DW79, 94 ( set of six)                | 00C31-032ABB |
| 6" Adjustable with Plate       | SF34 ( set of four)                   | 00C31-035AAA |
| Leg Accessory Kit              | BM23 (set of four)                    | 00C06-002A-- |
| 6" Adjustable with Plate       | GF24, 34, 48 ( set of four)           | 00C31-035AAA |
| 6" Black Leg                   | BB/DD 24, 36, 48, 72 (set of four)    | 58B02S001A   |
| 6" Adjustable with Plate       | BB58, 68, DD50, 58, 68 ( set of four) | 00C26S014A   |
| 6" Adjustable with Plate       | BB/DD 78, 94 ( set of six)            | 00C26S015A   |
| <b>LID LOCKS</b>               |                                       |              |
| Lid Lock                       | GF24/34                               | 00C30-100A   |
| Lid Lock                       | GF48                                  | 00C30-101A   |
| Lid Lock                       | SF34                                  | 00C30-031ABB |
| Lid Lock                       | DW49 Solid Lid                        | 00C30-030AAA |
| Lid Lock                       | DW64 Solid Lid                        | 00C30-029AAA |
| Lid Lock                       | DW79 Solid Lid                        | 00C30-028AAA |
| Lid Lock (2 required for DW94) | DW94 Solid Lid                        | 00C30-030AAA |

# Bar & Wine Accessories

| DESCRIPTION                        | UNIT(S)       | PART NUMBER |
|------------------------------------|---------------|-------------|
| <b>TAPS / FAUCETS / MANIFOLDS</b>  |               |             |
| Hole cover for cut out on DD units | ALL DD UNITS  | 00C10-006A  |
| 1 Tap 3" OD Beer Faucet            | ALL DD UNITS  | 406-053A    |
| 1 Tap 2 1/2" OD Beer Faucet        | ALL DD UNITS  | 406-004A--  |
| 2 Tap 3" OD Beer Faucet            | ALL DD UNITS  | 406-054A    |
| 3 Tap 3" OD Beer Faucet            | ALL DD UNITS  | 406-055A    |
| 4 Tap 3" OD Beer Faucet            | ALL DD UNITS  | 406-064A    |
| 5 Tap 3" OD Beer Faucet            | ALL DD UNITS  | 406-075A    |
| 1 Tap 3" OD Wine Faucet            | ALL DD UNITS  | 406-060A    |
| 1 Tap 2 1/2" OD Wine Faucet        | ALL DD UNITS  | 406-065A    |
| 2 Tap 3" OD Wine Faucet            | ALL DD UNITS  | 406-061A    |
| 3 Tap 3" OD Wine Faucet            | ALL DD UNITS  | 406-062A    |
| 4 Tap 3" OD Wine Faucet            | ALL DD UNITS  | 406-063A    |
| Single Faucet Adapter              | ALL DD UNITS  | 406-056A    |
| Double Faucet Adapter              | ALL DD UNITS  | 406-057A    |
| 2 Way Manifold                     | ALL DD UNITS  | 402-188A    |
| 3 Way Manifold                     | ALL DD UNITS  | 402-189A    |
| 4 Way Manifold                     | ALL DD UNITS  | 402-226A    |
| Turbo Tap                          | ALL DD UNITS  | 406-072A    |
| Turbo Tap Riser                    | ALL DD UNITS  | 406-074A    |
| <b>ADDITIONAL ACCESSORIES</b>      |               |             |
| Wire Divider (Step)                | DW UNITS      | 403-114D    |
| Wire Divider (Adjustable)          | DW UNITS      | 403-113D    |
| Wire Divider Spring                | DW UNITS      | 401-090AAB  |
| Cap Catcher (black)                | DW & SF UNITS | 09B30S025C  |
| Draft Arm Faucet Lock (slide on)   | ALL DD UNITS  | 401-909A    |
| Glass Rinser                       | ALL DD UNITS  | 406-067A    |





| DESCRIPTION  | PART NUMBER |
|--|-------------|
| 2' LED Liquor Shelf, 24"L X 4.5"W X .75" Thick, 2 wall brackets          | LS2-24L     |
| 3' LED Liquor Shelf, 36"L X 4.5"W X .75" Thick, 2 wall brackets          | LS3-36L     |
| 4' LED Liquor Shelf, 48"L X 4.5"W X .75" Thick, 3 wall brackets          | LS4-48L     |
| 5' LED Liquor Shelf, 60"L X 4.5"W X .75" Thick, 4 wall brackets          | LS5-60L     |
| 6' LED Liquor Shelf, 72"L X 4.5"W X .75" Thick, 5 wall brackets          | LS6-72L     |
| 2' Double Wide LED Liquor Shelf, 24"L X 9"W X .75 Thick, 2 wall brackets | LS2-24L-DW  |
| 3' Double Wide LED Liquor Shelf, 36"L X 9"W X .75 Thick, 2 wall brackets | LS3-36L-DW  |
| 4' Double Wide LED Liquor Shelf, 48"L X 9"W X .75 Thick, 3 wall brackets | LS4-48L-DW  |
| 5' Double Wide LED Liquor Shelf, 60"L X 9"W X .75 Thick, 4 wall brackets | LS5-60L-DW  |
| 6' Double Wide LED Liquor Shelf, 72"L X 9"W X .75 Thick, 5 wall brackets | LS6-72L-DW  |
| 2' Two Tier LED Bottle Display, 24"L X 9"D X 8"H                         | LBD2-24L    |
| 3' Two Tier LED Bottle Display, 36"L X 9"W X 8"H                         | LBD2-36L    |
| 4' Two Tier LED Bottle Display, 48"L X 9"W X 8"H                         | LBD2-48L    |
| 5' Two Tier LED Bottle Display, 60"L X 9"W X 8"H                         | LBD2-60L    |
| 6' Two Tier LED Bottle Display, 72"L X 9"W X 8"H                         | LBD2-72L    |
| 2' Three Tier LED Bottle Display, 24"L X 13.5"D X 12"H                   | LBD3-24L    |
| 3' Three Tier LED Bottle Display, 36"L X 13.5"D X 12"H                   | LBD3-36L    |
| 4' Three Tier LED Bottle Display, 48"L X 13.5"D X 12"H                   | LBD3-48L    |
| 5' Three Tier LED Bottle Display, 60"L X 13.5"D X 12"H                   | LBD3-60L    |
| 6' Three Tier LED Bottle Display, 72"L X 13.5"D X 12"H                   | LBD3-72L    |
| 2' Four Tier LED Bottle Display, 24"L X 18"W X 16"H                      | LBD4-24L    |
| 3' Four Tier LED Bottle Display, 36"L X 18"W X 16"H                      | LBD4-36L    |
| 4' Four Tier LED Bottle Display, 48"L X 18"W X 16"H                      | LBD4-48L    |
| 5' Four Tier LED Bottle Display, 60"L X 18"W X 16"H                      | LBD4-60L    |
| 6' Four Tier LED Bottle Display, 72"L X 18"W X 16"H                      | LBD4-72L    |

### Super Bright RGB LED Liquor Shelves

- 50,000 hours minimum life
- Environmentally friendly: no mercury, lead or toxic gases
- Color-rich, programmable LED's
- Available up to 8' Long
- 44 Key RGB Wireless Remote Control to control unlimited colors with multiple lighting effects
- Independent level control: choose colors for each step independent of the others
- Plugs into any standard wall outlet
- Modular Construction
- Includes UL listed power supply
- 100% Black Acrylic bottle tiers. Glossy black on front and sides with frosted acrylic tops.







# MILK COOLERS

MADE TO DELIVER CONSISTENT PERFORMANCE DURING REPEATED ACCESS

# MILK COOLERS

**CFC & HCFC-free insulation is foamed-in-place**  
for increased structural strength & energy efficiency

**Epoxy coated, steel wire racks included**  
for added floor protection

**Flexible compression door gaskets**  
ensure a tight seal for added temperature control

**Cylinder Locks**

**Bottom drain for connection to drain hose and easy cleaning**

**External digital thermometer**

**Coolers hold milk between 36°-38°F**  
until ready to serve for maximum refreshment



**ONE-PIECE BOTTOM FOR MAXIMUM SUPPORT**

**3 YEAR PARTS & LABOR WARRANTY WITH AN ADDITIONAL 2 YEAR COMPRESSOR WARRANTY**

**MADE IN USA**



**ONE-PIECE REINFORCED FLOOR**  
for maximum milk crate support and made with stainless steel



**SINGLE AND DUAL ACCESS**  
models available

**ACCESS OPTIONS**

- Metal lids

**AGENCY CERTIFICATIONS**



## COLD WALL - SINGLE ACCESS

MAINTAINS PRODUCT TEMPERATURES OF 32-40°F.

| MODEL WIDTH | MODEL #     | VOLTS | HP  | AMPS | CUBIC FEET | WIDTH | DEPTH | HEIGHT | CRATED WEIGHT | CASE CAPACITY<br>13 X 13 X 11" | CASE CAPACITY<br>19 X 13 X 11" | EXTERIOR FINISH | INTERIOR FINISH |
|-------------|-------------|-------|-----|------|------------|-------|-------|--------|---------------|--------------------------------|--------------------------------|-----------------|-----------------|
| 34"         | SM34HC-S    | 115   | 1/3 | 2.2  | 12.73      | 34    | 30.63 | 41.13  | 271           | 8                              | 4                              | STAINLESS       | STAINLESS       |
|             | SM34HC-W    |       |     |      |            |       |       |        | 277           | 8                              | 4                              | WHITE           | WHITE           |
|             | SM34HC-W-02 |       |     |      |            |       |       |        | 237           | 8                              | 4                              | WHITE           | STAINLESS       |
| 49"         | SM49HC-S    | 115   | 1/3 | 2.2  | 20.32      | 49    | 30.63 | 41.13  | 338           | 12                             | 8                              | STAINLESS       | STAINLESS       |
|             | SM49HC-W    |       |     |      |            |       |       |        | 339           | 12                             | 8                              | WHITE           | WHITE           |
|             | SM49HC-W-02 |       |     |      |            |       |       |        | 340           | 12                             | 8                              | WHITE           | STAINLESS       |
| 58"         | SM58HC-S    | 115   | 1/3 | 2.2  | 22.63      | 58    | 30.63 | 41.13  | 384           | 16                             | 10                             | STAINLESS       | STAINLESS       |
|             | SM58N-W     |       |     |      |            |       |       |        | 376           | 16                             | 10                             | WHITE           | WHITE           |
|             | SM58N-W-02  |       |     |      |            |       |       |        | 376           | 16                             | 10                             | WHITE           | STAINLESS       |

Depth measurement includes handles. Height measurement includes mounting height.

## FORCED AIR - SINGLE ACCESS

MAINTAINS PRODUCT TEMPERATURES OF 32-40°F.

| MODEL WIDTH | MODEL #        | VOLTS | HP  | AMPS | CUBIC FEET | WIDTH | DEPTH | HEIGHT | CRATED WEIGHT | CASE CAPACITY<br>13 X 13 X 11" | CASE CAPACITY<br>19 X 13 X 11" | EXTERIOR FINISH | INTERIOR FINISH |
|-------------|----------------|-------|-----|------|------------|-------|-------|--------|---------------|--------------------------------|--------------------------------|-----------------|-----------------|
| 34"         | SMF34HC-1-S    | 115   | 1/6 | 7.5  | 13.59      | 34    | 33.63 | 46.88  | 335           | 8                              | 4                              | STAINLESS       | STAINLESS       |
|             | SMF34HC-1-W    |       |     |      |            |       |       |        | 335           | 8                              | 4                              | WHITE           | WHITE           |
|             | SMF34HC-1-W-02 |       |     |      |            |       |       |        | 335           | 8                              | 4                              | WHITE           | STAINLESS       |
| 49"         | SMF49HC-1-S    | 115   | 1/4 | 3    | 19.66      | 49    | 33.63 | 46.88  | 437           | 12                             | 8                              | STAINLESS       | STAINLESS       |
|             | SMF49HC-1-W    |       |     |      |            |       |       |        | 437           | 12                             | 8                              | WHITE           | WHITE           |
|             | SMF49HC-1-W-02 |       |     |      |            |       |       |        | 437           | 12                             | 8                              | WHITE           | STAINLESS       |
| 58"         | SMF58HC-1-S    | 115   | 1/3 | 3.3  | 24         | 58    | 33.63 | 46.88  | 458           | 16                             | 10                             | STAINLESS       | STAINLESS       |
|             | SMF58HC-1-W    |       |     |      |            |       |       |        | 458           | 16                             | 10                             | WHITE           | WHITE           |
|             | SMF58HC-1-W-02 |       |     |      |            |       |       |        | 458           | 16                             | 10                             | WHITE           | STAINLESS       |

Depth measurement includes handles. Height measurement includes mounting height.

### EXTERIOR FINISHES

- White coated steel
- Stainless steel

### INTERIOR FINISHES

- Galvanized steel
- Stainless Steel

### AVAILABLE ACCESSORIES

- Cow Spot graphics
- Custom graphics available
- Corner & Wrap-around bumpers

### MOUNTING OPTIONS

- 4" casters (SM models only)
- 7" casters (SMF models only)



# MILK COOLERS

## COLD WALL - DUAL ACCESS

MAINTAINS PRODUCT TEMPERATURES OF 32-40°F.

| MODEL WIDTH | MODEL #     | VOLTS | HP  | AMPS | CUBIC FEET | WIDTH | DEPTH | HEIGHT | CRATED WEIGHT | CASE CAPACITY<br>13 X 13 X 11" | CASE CAPACITY<br>19 X 13 X 11" | EXTERIOR FINISH | INTERIOR FINISH |
|-------------|-------------|-------|-----|------|------------|-------|-------|--------|---------------|--------------------------------|--------------------------------|-----------------|-----------------|
| 34"         | ST34HC-S    | 115   | 1/2 | 3.7  | 12.37      | 34    | 31.25 | 41.13  | 270           | 8                              | 4                              | STAINLESS       | STAINLESS       |
|             | ST34HC-W    |       |     |      |            |       |       |        | 270           | 8                              | 4                              | WHITE           | WHITE           |
|             | ST34HC-W-02 |       |     |      |            |       |       |        | 270           | 8                              | 4                              | WHITE           | STAINLESS       |
| 49"         | ST49HC-S    | 115   | 1/2 | 3.7  | 18.97      | 49    | 31.25 | 41.13  | 336           | 12                             | 8                              | STAINLESS       | STAINLESS       |
|             | ST49HC-W    |       |     |      |            |       |       |        | 336           | 12                             | 8                              | WHITE           | WHITE           |
|             | ST49HC-W-02 |       |     |      |            |       |       |        | 336           | 12                             | 8                              | WHITE           | STAINLESS       |
| 58"         | ST58HC-S    | 115   | 1/2 | 3.7  | 22.5       | 58    | 31.25 | 41.13  | 372           | 16                             | 10                             | STAINLESS       | STAINLESS       |
|             | ST58HC-W    |       |     |      |            |       |       |        | 372           | 16                             | 10                             | WHITE           | WHITE           |
|             | ST58HC-W-02 |       |     |      |            |       |       |        | 372           | 16                             | 10                             | WHITE           | STAINLESS       |

*Depth measurement includes handles.  
Height measurement includes mounting height.*

## FORCED AIR - DUAL ACCESS

MAINTAINS PRODUCT TEMPERATURES OF 32-40°F.

| MODEL WIDTH | MODEL #        | VOLTS | HP  | AMPS | CUBIC FEET | WIDTH | DEPTH | HEIGHT | CRATED WEIGHT | CASE CAPACITY<br>13 X 13 X 11" | CASE CAPACITY<br>19 X 13 X 11" | EXTERIOR FINISH | INTERIOR FINISH |
|-------------|----------------|-------|-----|------|------------|-------|-------|--------|---------------|--------------------------------|--------------------------------|-----------------|-----------------|
| 49"         | STF49HC-1-S    | 115   | 1/3 | 3.3  | 20.55      | 49    | 34    | 47.75  | 400           | 12                             | 8                              | STAINLESS       | STAINLESS       |
|             | STF49HC-1-W    |       |     |      |            |       |       |        | 417           | 12                             | 8                              | WHITE           | WHITE           |
|             | STF49HC-1-W-02 |       |     |      |            |       |       |        | 417           | 12                             | 8                              | WHITE           | STAINLESS       |
| 58"         | STF58HC-1-S    | 115   | 1/3 | 3.3  | 24.3       | 58    | 34    | 47.75  | 498           | 16                             | 10                             | STAINLESS       | STAINLESS       |
|             | STF58HC-1-W    |       |     |      |            |       |       |        | 498           | 16                             | 10                             | WHITE           | WHITE           |
|             | STF58HC-1-W-02 |       |     |      |            |       |       |        | 498           | 16                             | 10                             | WHITE           | STAINLESS       |

*Depth measurement includes handles.  
Height measurement includes mounting height.*

| DESCRIPTION                        | UNIT(S)   | PART NUMBER |
|------------------------------------|---|-------------|
| <b>MOUNTING</b>                    |   |             |
| 4" Plate Caster (standard)         | SM/ST 34,49,58 (per caster-2 required per cabinet)    | 401-094A    |
| 4" Plate Caster w/brake (standard) | SM/ST 34,49,58 (per caster-2 required per cabinet)    | 401-099A    |
| 7" Plate Caster (standard)         | SMF34,SMF49,SMF58 (per caster-2 required per cabinet) | 401-519A    |
| 7" Plate Caster w/brake (standard) | SMF34,SMF49,SMF58 (per caster-2 required per cabinet) | 401-520A    |
| 5" Plate Caster w/brake (standard) | STF49/STF58 (per caster-2 required per cabinet)       | 401-127A    |
| 5" Plate Caster (standard)         | STF49/STF58 (per caster-2 required per cabinet)       | 401-209A    |
| 6" Adjustable with Plate           | SM34,49,58 ST34,49,58 ( set of four)                  | 00C06-003A  |

|  |                              |               |
|--|------------------------------|---------------|
| <b>BUMPERS</b> <i>(Require field tapping and installation)</i> |                              |               |
| Wrap Around Bumpers  | SM/ST34                      | 00C01-004A    |
| Wrap Around Bumpers  | SM/ST49                      | 00C01-005A    |
| Wrap Around Bumpers  | SM/ST58                      | 00C01-006A    |
| Wrap Around Bumpers  | SMF34                        | 00C01-009A    |
| Wrap Around Bumpers  | SMF49                        | 00C01-010A    |
| Wrap Around Bumpers  | SMF58                        | 00C01-011A    |
| Corner Bumpers (single)  | All Milk Coolers             | 703-868A      |
| Corner Bumpers (Set of 4)                                      | Corner Bumper Kit (set of 4) | 00C01-012A-01 |

|                              |                                     |              |
|------------------------------|-------------------------------------|--------------|
| <b>DECALS</b>                |                                     |              |
| Base Kit (Cow Spots)         | SM34, ST34, SMF34                   | 807-836C     |
| 1 Base Kit (Cow Spots)       | SM49, ST49, SMF49                   | 807-836C     |
| Supplemental Kit (Cow Spots) | SM49, ST49, SMF49                   | 807-837C     |
| 1 Base Kit (Cow Spots)       | SM58, ST58, SMF58                   | 807-836C     |
| Supplemental Kit (Cow Spots) | SM58, ST58, SMF58 (2 kits required) | 807-837C     |
| Got Milk® Lid Decal          | SMF/SM/ST34                         | 807-839C-001 |
| Got Milk Lid Decal           | SMF/SM/ST49                         | 807-839C-002 |
| Got Milk Lid Decal           | SMF/SM/ST58                         | 807-839C-003 |
| Got Milk Lid Decal           | STF49                               | 807-839C-004 |
| Got Milk Lid Decal           | STF58                               | 807-839C-005 |
| Got Milk Door Decal          | SMF/SM/ST34                         | 807-839C-006 |
| Got Milk Door Decal          | SMF/SM/ST49                         | 807-839C-007 |
| Got Milk Door Decal          | SMF/SM/ST58                         | 807-839C-008 |

# WARRANTY

## SALES TERMS (Warranty valid in USA and Canada)

---

### PRICES & SPECIFICATIONS

Beverage-Air reserves the right to change the price and specifications of the equipment and/or material without notice. Prices are F.O.B. plant of manufacture.

### CANCELLATION

Buyer may cancel its order, reduce quantities, revise specifications, or extend schedules only by mutual agreement as to reasonable and proper cancellation charges which shall take into account expenses already incurred and commitment made by seller, and buyer shall indemnify seller against any loss.

### FREIGHT CLASS

All Beverage-Air products ship under 150 freight classification.

### CUSTOMER'S FREIGHT DAMAGE PROCEDURE

Before signing the carrier's freight bill the customer should do the following:

#### Visible Damage:

1. Inspect shipment for any damage. If you see damage or feel there may be concealed damage, mark the carrier's copy of the freight bill "damaged".
2. If there is damage to your shipment, action must be taken by you to notify Beverage Air immediately. A freight claim must be filed with the carrier and an inspection scheduled by the carrier. It is the duty of the carrier to give you a written report upon notification. (VISIBLE AND CONCEALED).
3. For visible damage, where possible, do not accept delivery unless the condition noted on your copy of the freight bill and signed by the driver.

#### Concealed Damage:

4. If the damage is concealed, notify the carrier within 5 days of the receipt of the product by phone and in writing as well as Beverage Air. Ask them to send their agent to complete an inspection report. Retain all cartons and merchandise for inspection. It is critical that the customer take the above actions; without these steps claims for concealed damages may be denied.

### 3RD PARTY FREIGHT

3rd Party Freight shipments are FOB factory and are not eligible for refusal at time of delivery. ALL 3RD PARTY SHIPMENTS ARE THE RESPONSIBILITY OF THE SHIPPER. Claims for damaged product are to be filed by the shipper and Beverage Air will not be liable. This product is not eligible for return to our warehouse facility.

### RETURN OF PRODUCT

**EQUIPMENT** - Prior Authorization must be granted by Beverage-Air before equipment can be returned for credit. Returns will only be authorized within 90 days of invoice date. Return authorizations are valid for 30 days. Equipment approved for return is subject to a 25% restocking charge.

Returned equipment must be shipped freight prepaid, packed in original carton, and received in good condition.

**PARTS** - Prior Authorization must be granted by Beverage-Air before parts can be returned for credit. Returns will only be authorized within 30 days of invoice date. Return authorizations are valid for 30 days. Parts approved for return are subject to a 25% restocking charge. Returned parts must be shipped freight prepaid, in the original packaging, and received in good condition.

### LIMITATION OF LIABILITY:

Beverage-Air Corporation or their affiliates shall not be liable for any indirect, incidental, special or consequential damages, or losses of a commercial nature arising out of malfunction equipment or its parts components thereof, as a result of defects in material or workmanship.

THE ORIGINAL OWNER'S SOLE AND EXCLUSIVE REMEDY AND BEVERAGE-AIR'S SOLE AND EXCLUSIVE LIABILITY SHALL BE LIMITED TO THE REPAIR OR REPLACEMENT OF PARTS OR COMPONENTS CONTAINED IN THE EQUIPMENT IDENTIFIED ABOVE WHICH UNDER NORMAL USE AND SERVICE MALFUNCTION AS A RESULT OF DEFECTS IN MATERIAL OR WORKMANSHIP, SUBJECT TO THE APPLICABLE PROVISIONS AND LIMITATIONS STATED ABOVE.

Notice: Additional Terms and Conditions of sale may apply. Notice: Specifications Subject to Change Without Notice. Contact factory for specific model agency approval. All prices are ex-works Brookville, Pennsylvania.



### THREE (3) YEAR PARTS AND LABOR WARRANTY (CF/CT MODELS CARRY ONE (1) YEAR PARTS AND LABOR WARRANTY LIMITED TO FIFTEEN (15) MONTHS FROM DATE OF SHIPMENT)

Beverage-Air Corporation warrants to the original purchaser of Beverage-Air branded equipment, including all parts thereof, that such equipment is free from defects in material and workmanship, under normal use, proper maintenance, and service as indicated by Beverage-Air installation and operation instructions, for a period of three (3) years from the date of installation, or thirty-nine (39) months from the date of shipment from the manufacturer, whichever is earlier.

Normal wear type parts, such as light bulbs/lamps and gaskets are not covered by this warranty. For the purpose of this warranty, the original purchaser shall be deemed to mean the individual or company for who the product was originally installed.

Our obligation under this warranty shall be limited to repairing or replacing, including labor, any part of such product, which proves thus defective. Beverage-Air reserves the right to examine any product claimed to be defective.

The labor warranty shall be for self-contained units only and for standard straight time, which is defined as normal service rate time, for service performed during normal working hours. Any service requested outside of a servicer's normal working hours will be covered under this warranty at the normal rate and any additional overtime rate will be at the responsibility of the equipment purchaser.

Any part determined to be defective in the product should be returned to the company within thirty (30) days under the terms of this warranty and must be accompanied by a record of the cabinet model, serial number, and identified with a return material authorization number (RMA#) issued by the manufacturer.

Special installation/applications, including remote locations, are limited in coverage by this warranty. Any installation that requires extra work, and/or travel, to gain access to the unit for service is the sole responsibility of the equipment purchaser.

Improper operation resulting from factors, including but not limited to: *improper or negligent cleaning and maintenance, low voltage conditions, inadequate wiring, outdoor use (unless otherwise specified) and accidental damage*, are not manufacturing defects and are strictly the responsibility of the purchaser.

With the exception of Blast Chillers product is designed for maintaining temperature and not bringing food to a desired temperature therefore cannot be held responsible for this function under warranty.

Condensing coils must be cleaned at regular intervals. Failure to do so can cause compressor malfunction and will void warranty. Although cleaning requirements vary in accordance with operation of various products, Beverage-Air recommends a minimum monthly cleaning.

### ADDITIONAL TWO (2) YEAR COMPRESSOR PART WARRANTY

In addition to the warranty set forth above, Beverage-Air warrants the hermetically/semi-hermetically sealed compressor (part only) for an additional two (2) years beyond the first three (3) years warranty period; not to exceed sixty-three (63) months from the date of shipment from Beverage-Air, provided upon receipt of the

compressor, manufacturer examination shows the sealed compressor to be defective. This extended warranty does not cover freight for the replacement compressor or freight for the return of the failed compressor. Also, this extended compressor-part only warranty does NOT apply to any electrical controls, condenser, evaporator, fan motors, overload switch, starting relay, capacitors, temperature control, filter/drier, accumulator, refrigeration tubing, wiring harness, labor charges, or supplies which are covered by the standard warranty above.

### NO CLAIMS CAN BE MADE AGAINST THIS WARRANTY FOR SPOILAGE OF PRODUCTS, LOSS OF SALES OR CONSEQUENTIAL DAMAGES

THE FOREGOING WARRANTIES ARE EXPRESSLY GIVEN IN LIEU OF ALL OTHER WARRANTIES, EXPRESS, IMPLIED, OR STATUTORY, INCLUDING THE IMPLIED WARRANTIES OF MERCHANTABILITY AND FITNESS FOR A PARTICULAR PURPOSE, WHICH ARE HERBY DISCLAIMED, ALL OTHER OBLIGATIONS OR LIABILITIES ON OUR PART, AND WE NEITHER ASSUME, NOR AUTHORIZE ANY OTHER PERSON TO ASSUME FOR US, ANY OBLIGATION OR LIABILITY IN CONNECTION WITH THE SALE OF SAID REFRIGERATION UNITS OR ANY PARTS THERE OF.

This warranty shall not be assignable and shall be honored only in so far as the original purchaser. This warranty does not apply outside the limits of the United States of America and Canada, nor does it apply to any part that has been subject to misuse, neglect alteration, accident, or to any damage caused by transportation, flood, fire, acts of terrorism, or acts of God.

**Residential applications:** Units installed in residential applications will be warranted for a period of 1 year parts & labor from the date of original shipment.

# CONTACTS

**1 Professional Reps**  
ph: (877) 995-8922  
fax: (602) 864-1754  
email: brian@professionalreps.com  
territory: Ohio, Kentucky, Western quarter of Pennsylvania, West Virginia

**2 CR Peterson**  
ph: (800) 257-4040  
fax: (508) 238-3647  
email: jim@crpeterson.com  
territory: Maine, New Hampshire, Vermont, Connecticut, Rhode Island, Massachusetts

**3 Charles Pace & Associates, Inc.**  
ph: (770) 969-0488  
fax: (770) 969-7277  
email: ronnie@rycgroup.com  
territory: Georgia, Alabama, Tennessee (Central and Eastern), Florida (panhandle)

**4 The Schmid-Wilson Group**  
ph: (410) 998-9191  
fax: (410) 998-9195  
email: swg@theswg.com  
territory: Maryland, District of Columbia, Virginia

**5 TD Marketing**  
ph: (201) 935-1600  
fax: (201) 935-1260  
email: fdoyle@tdmarketingco.com  
territory: New Jersey (Northern half of NJ), New York (Metro)

**6 Ettinger Rosini/Waypoint**  
ph: (214) 343-2548  
fax: (214) 343-2727  
email: julie@ettros.com  
territory: Oklahoma, Texas (except El Paso County)

**7 Professional Reps**  
ph: (877) 995-8922  
fax: (602) 864-1754  
email: brian@professionalreps.com  
territory: Arizona, Colorado, New Mexico, Utah, Wyoming, Texas (El Paso County only)

**8 4 Star Reps**  
ph: (267) 522-8991  
email: khiggins@4starreps.com  
territory: Delaware (entire state), Pennsylvania (east of and including Bradford, Lycoming, Milton, Union, Mifflin, Juniata, Perry, Cumberland, & Adam Counties) New Jersey (south of and including Mercer, Burlington, and Ocean counties)

**9 Swanson-Girard**  
ph: (704) 521-8811  
fax: (704) 521-8801  
email: sgirard@swanson-girard.com  
territory: North Carolina, South Carolina

**10 Lund-Iorio**  
ph: (949) 443-4855  
fax: (949) 443-4856  
email: scott@lund-iorio.com  
territory: Nevada (Clark County), California (CA/Mexico border and southern third of state)

**11 Kelly-Mincks**  
ph: (425) 481-9036  
fax: (425) 806-5283  
email: bill@kelly-mincks.com  
territory: Washington, Oregon, Alaska, Montana, Idaho, Hawaii

**12 The YES Group**  
ph: (651) 452-9889  
fax: (651) 452-3804  
email: justin@TheYesGroup.com  
territory: Minnesota, North Dakota, South Dakota, Wisconsin

**13 Walter Zebrowski Associates**  
ph: (415) 883-3222  
fax: (415) 883-9332  
email: tom@walterzebrowskiassoc.com  
territory: Nevada (entire state except Clark County), California (Northern two thirds of state)

**14 Professional Reps**  
ph: (877) 995-8922  
fax: (602) 864-1754  
email: brian@professionalreps.com  
territory: Utah, Wyoming, Colorado

**15 Tepper & Associates, Inc.**  
ph: (727) 322-1212  
fax: (727) 322-1313  
email: info@tepperreps.com  
territory: Florida (except the panhandle)

**16 J Wilson Marketing**  
ph: (518) 692-8083  
fax: (518) 692-8084  
email: joe@jwilsonmarketing.com  
territory: New York (except Metro/ NYC)

**17 Central Marketing Associates, Inc.**  
ph: (913) 897-2390  
fax: (913) 897-2391  
email: steve@cmafoods-service.com  
territory: Missouri, Kansas, Iowa, Nebraska, Illinois (Southern two thirds of state)

**18 Cassidy's Pro Line**  
ph: (630) 627-7353  
fax: (630) 628-3529  
email: prolinerep@aol.com  
territory: Illinois (Northern third of state)

**19 ECHO Foodservice Marketing Agents**  
ph: (504) 458-7012  
fax: (504) 617-6607  
email: bruce@echofoodservicecmktg.com  
territory: Mississippi, Western Tennessee, Arkansas, Louisiana

**20 Phoenix Marketing**  
ph: 1(866) 377-8417  
fax: (317) 534-3994  
email: kford@phoenix-reps.com  
territory: Indiana, Michigan

**21 Castle Agencies**  
ph: (604) 904-7681  
fax: (604) 904-7682  
email: king@castleagencies.ca  
territory: British Columbia, Yukon

**22 The Solutions Group, Inc.**  
ph: (905) 760-1777  
email: cmuzylo@solutionfsg.com  
territory: Ontario (except Lakehead region), Quebec & Maritimes

**23 The Solutions Group, Inc.**  
ph: (905) 760-1777  
email: cmuzylo@solutionfsg.com  
territory: Ontario (except Lakehead region), Quebec & Maritimes

**24 Fred Peters Agencies Ltd.**  
ph: (403) 266-4360  
email: bpatfpa@shaw.ca  
territory: Alberta, Northwest Territories

**25 Simpson-Wilson Ltd.**  
ph: (800) 342-3626  
fax: (204) 633-9254  
email: cam@simpsonwilson.com  
territory: Manitoba, Saskatchewan, Ontario (Lakehead region only)

**26 Professional Reps**  
ph: (877) 995-8922  
fax: (602) 864-1754  
email: brian@professionalreps.com  
territory: New Mexico, El Paso County Texas

**Factory Headquarters Sales Office**

3779 Champion Blvd  
Winston-Salem, NC 27105  
Phone: (336) 245-6400  
Fax: (336) 245-6453  
Email: sales@bevair.com  
Web: www.beverage-air.com

**Food Service Manufacturing Facility**

Parts RG's:  
1082 Route 28  
Brookville, PA 15825

Equipment RG's:  
1082 Route 28  
Brookville, PA 15825

**24/7 Warranty Service**  
(877) 866-1223

**Factory Technical Service**  
Phone: (800) 684-1199  
Fax: (800) 262-9381

**Factory Customer Service**  
Phone: (888) 845-9800  
Fax: (800) 253-5168

**For warranty service you may call  
your dealer, local service company,  
or our 24-hour Warranty Service  
Dispatch (877) 866-1223**

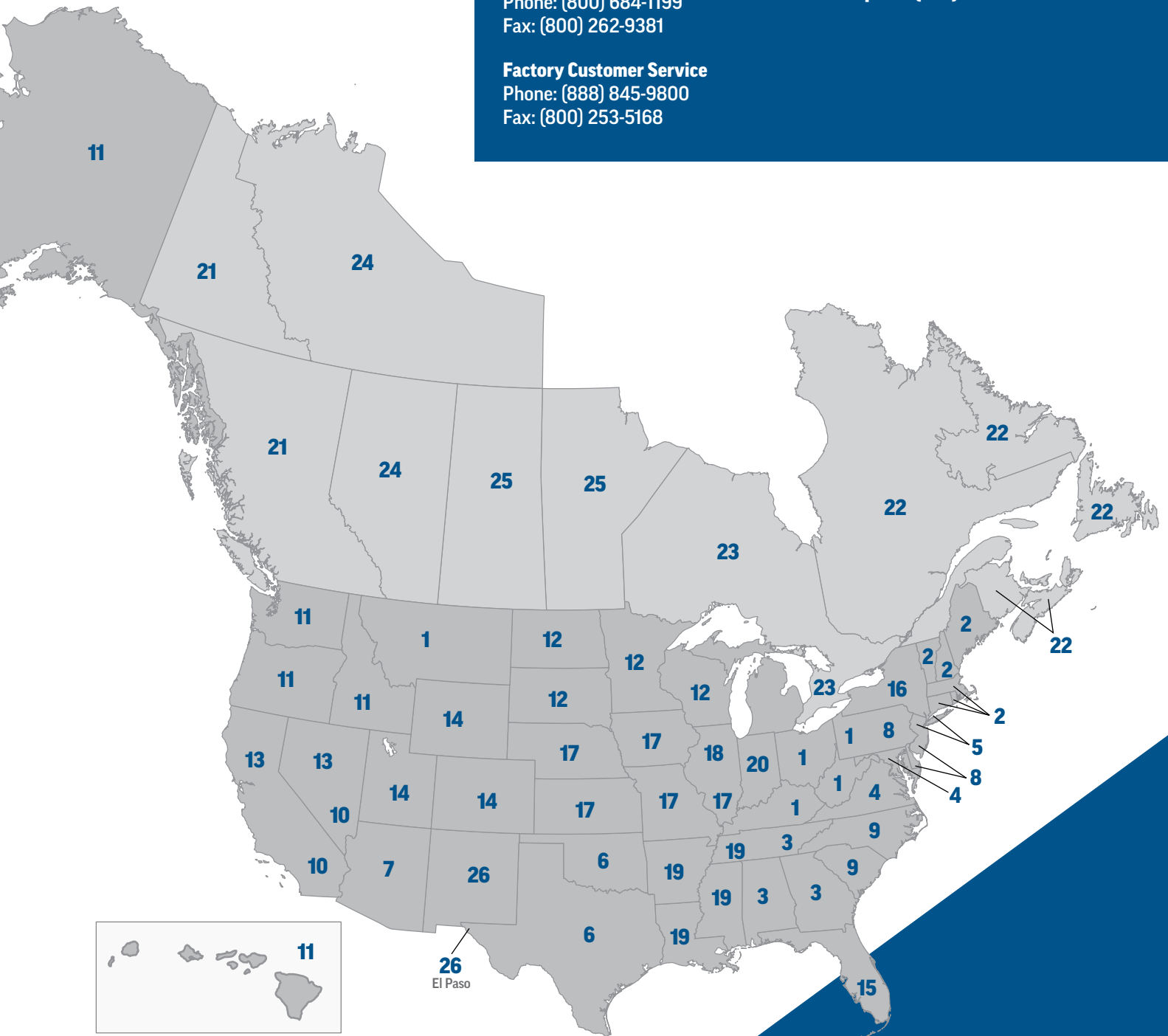



# YOUR **COMPLETE** REFRIGERATION SOURCE

2019 MASTER

@beverageair



**888-845-9800**  
**beverage-air.com**

3779 CHAMPION BLVD.  
WINSTON-SALEM, NC 27105  
PHONE: (888) 845-9800 | FAX: (800) 253-5168  
EMAIL: SALES@BEVAIR.COM  
WEB: BEVERAGE-AIR.COM

an Ali Group Company



The Spirit of Excellence